

# LOWRANCE®

www.lowrance.com

Pub. 988-0152-181



# LMS-522c iGPS & LMS-527cDF iGPS

Fish-finding Sonar & Mapping GPS  
Installation and Operation  
Instructions

**Copyright © 2006 Lowrance Electronics, Inc.  
All rights reserved.**

No part of this manual may be copied, reproduced, republished, transmitted or distributed for any purpose, without prior written consent of Lowrance. **Any unauthorized commercial distribution of this manual is strictly prohibited.**

Lowrance® is a registered trademark of Lowrance Electronics, Inc. MapCreate™, FreedomMaps™ and NauticPath™ are trademarks of LEI. Fishing Hot Spots® is a registered trademark of Fishing Hot Spots Inc. LakeMaster® and Pro Maps are trademarks or registered trademarks of WayPoint Technologies, Inc. Navionics® is a registered trademark of Navionics, Inc. DURACELL® is a registered trademark of Duracell, Inc. RAYOVAC® is a registered trademark of Rayovac Corporation. Energizer® and e2® are registered trademarks of Energizer Holdings, Inc.



Points of Interest Data in this unit are by infoUSA, copyright © 2001-2006, All Rights Reserved. infoUSA is a trademark of infoUSA, Inc.

Lowrance Electronics may find it necessary to change or end our policies, regulations and special offers at any time. We reserve the right to do so without notice. All features and specifications subject to change without notice. All screens in this manual are simulated. On the cover: LMS-527CDF iGPS.

**For free owner's manuals and the most current information on  
this product, its operation and accessories,  
visit our web site:  
[www.lowrance.com](http://www.lowrance.com)**

Lowrance Electronics Inc.  
12000 E. Skelly Dr.  
Tulsa, OK USA 74128-2486  
Printed in USA.

## Table of Contents

|   |           |
|---|-----------|
| <b>Section 1: Read Me First!</b> .....                            | <b>1</b>  |
| Specifications: LMS-522c iGPS and LMS-527cDF iGPS .....           | 3         |
| How to use this manual: typographical conventions .....           | 10        |
| <b>Section 2: Installation</b> .....                              | <b>13</b> |
| Preparations .....  | 13        |
| Transducer Installation .....                                     | 13        |
| Single-frequency transom installations .....                      | 14        |
| Dual-frequency transom installations .....                        | 14        |
| Single-frequency trolling motor installations .....               | 14        |
| Shoot-through hull installations .....                            | 14        |
| Selecting a Transducer Location .....                             | 14        |
| How low should you go? .....                                      | 15        |
| Shoot-thru-hull vs. Transom Mounting .....                        | 16        |
| Transom Transducer Assembly And Mounting .....                    | 17        |
| Trolling Motor Bracket Installation (single-frequency only) ..... | 23        |
| Transducer Orientation and Fish Arches .....                      | 23        |
| Shoot-Thru-Hull Preparation .....                                 | 24        |
| Hulls With Flotation Materials .....                              | 24        |
| Testing Determines Best Location .....                            | 25        |
| Shoot-thru-hull Installation .....                                | 27        |
| <b>Speed/Temperature Sensors</b> .....                            | <b>28</b> |
| Optional Speed Sensor Installation .....                          | 28        |
| Power Connections .....   | 30        |
| Powering Your Display Unit .....                                  | 31        |
| Power Diagram A .....   | 32        |
| Power Diagram B .....   | 33        |
| Powering a NMEA 2000 Network Bus .....                            | 33        |
| Connecting to a NMEA 2000 Network .....                           | 34        |
| NMEA 0183 Wiring (Data cable) .....                               | 34        |
| Mounting the Unit: Bracket or Portable .....                      | 35        |
| MMC or SD Card Memory Card Installation .....                     | 39        |
| Other Accessories .....   | 40        |
| Cleaning Towel .....  | 40        |
| Face Cover .....  | 41        |
| <b>Section 3: Basic Sonar Operation</b> .....                     | <b>43</b> |
| Keyboard .....  | 43        |
| Power/lights on and off .....                                     | 44        |
| Main Menu .....   | 44        |
| Pages .....   | 46        |
| Satellite Status Page .....                                       | 46        |
| Navigation Page .....   | 47        |
| Map Page .....  | 47        |

|  |           |
|--|-----------|
| Sonar Page .....                                     | 48        |
| <b>Basic Sonar Quick Reference .....</b>             | <b>51</b> |
| Sonar Operations .....                               | 52        |
| Fish Symbols vs. Full Sonar Chart .....              | 54        |
| Other Free Training Aids .....                       | 55        |
| <b>Section 4: Sonar Options .....</b>                | <b>57</b> |
| ASP™ (Advanced Signal Processing) .....              | 57        |
| Alarms .....   | 58        |
| Depth Alarms .....                                   | 58        |
| Zone Alarm .....                                     | 59        |
| Fish Alarm .....                                     | 60        |
| GPS Alarms .....                                     | 61        |
| NMEA 2000 Alarms .....                               | 62        |
| Calibrate Speed .....                                | 63        |
| Chart Speed .....                                    | 64        |
| Colorline™ .....                                     | 65        |
| Depth Cursor .....                                   | 66        |
| Depth Range - Automatic .....                        | 67        |
| Depth Range - Manual .....                           | 67        |
| Depth Range - Upper and Lower Limits .....           | 68        |
| FasTrack™ .....                                      | 69        |
| Fish I.D.™ (Fish Symbols & Depths) .....             | 70        |
| FishTrack™ .....                                     | 72        |
| Frequency (Change Frequency) (LMS-527cDF only) ..... | 72        |
| HyperScroll™ .....                                   | 73        |
| Log Sonar Chart Data .....                           | 74        |
| Noise Rejection .....                                | 75        |
| Overlay Data .....                                   | 75        |
| Ping Speed & HyperScroll™ .....                      | 78        |
| Reset Options .....                                  | 79        |
| Reset Water Distance .....                           | 80        |
| Set Keel Offset .....                                | 80        |
| Sensitivity & Auto Sensitivity .....                 | 81        |
| Automatic Sensitivity .....                          | 82        |
| Sonar Chart Mode .....                               | 83        |
| Sonar Page & Sonar Chart Display Options .....       | 84        |
| Full Sonar Chart .....                               | 84        |
| Split Zoom Sonar Chart .....                         | 85        |
| Split Frequency Sonar Chart (LMS-527cDF only) .....  | 85        |
| Digital Data/Chart .....                             | 86        |
| Customize Page Displays .....                        | 86        |
| Flasher .....  | 88        |
| Sonar with Custom Gauges .....                       | 88        |

|  |            |
|--|------------|
| Sonar Simulator .....                                | 91         |
| Stop Chart.....                                      | 93         |
| Surface Clarity .....                                | 94         |
| Transparency.....                                    | 95         |
| Upper and Lower Limits.....                          | 96         |
| Zoom & Zoom Bar.....                                 | 96         |
| Zoom Pan .....                                       | 96         |
| <b>Section 5: Sonar Troubleshooting .....</b>        | <b>97</b>  |
| <b>Section 6: Basic GPS Operations .....</b>         | <b>101</b> |
| Keyboard.....  | 101        |
| Power/lights on and off .....                        | 102        |
| Main Menu.....                                       | 102        |
| Pages .....  | 104        |
| Sonar Page.....                                      | 104        |
| Satellite Status Page.....                           | 104        |
| Navigation Page .....                                | 106        |
| Map Page .....                                       | 109        |
| Background map vs. MapCreate map content .....       | 110        |
| Map with Sonar .....                                 | 113        |
| Map with Custom Gauges.....                          | 114        |
| Radar.....   | 115        |
| <b>Basic GPS Quick Reference .....</b>               | <b>117</b> |
| Find Your Current Position.....                      | 118        |
| Moving Around the Map: Zoom & Cursor Arrow Keys..... | 118        |
| Selecting Any Map Item With the Cursor .....         | 119        |
| Searching .....                                      | 119        |
| Set a Waypoint .....                                 | 121        |
| Navigate To a Waypoint .....                         | 123        |
| Set Man Overboard (MOB) Waypoint.....                | 123        |
| Navigate Back to MOB Waypoint.....                   | 124        |
| Navigate to Cursor Position on Map.....              | 124        |
| Navigate to a Point of Interest .....                | 126        |
| Creating and Saving a Trail.....                     | 126        |
| Displaying a Saved Trail .....                       | 128        |
| Navigating Trails .....                              | 129        |
| Visual Trailing.....                                 | 129        |
| Navigate a Trail (forward).....                      | 129        |
| Navigate a Back Trail (backtrack, or reverse) .....  | 131        |
| Transfer Custom Maps and GPS Data Files .....        | 132        |
| Custom Maps:.....                                    | 132        |
| GPS Data files: .....                                | 132        |
| Cancel Navigation.....                               | 134        |
| <b>Section 7: Advanced GPS Operations.....</b>       | <b>135</b> |

|  |            |
|--|------------|
| Find Distance from different Locations .....           | 135        |
| Find Distance from Point to Point .....                | 135        |
| Icons .....  | 136        |
| Create Icon on Map .....                               | 136        |
| Create Icon at Current Position .....                  | 136        |
| Delete an Icon .....                                   | 136        |
| Navigate to an Icon .....                              | 137        |
| Routes .....   | 137        |
| Create and Save a Route .....                          | 138        |
| Delete a Route .....                                   | 140        |
| Edit a Route Name .....                                | 141        |
| Edit Route Waypoints .....                             | 141        |
| Navigate a Route .....                                 | 142        |
| Navigate a Route in Reverse .....                      | 142        |
| Trails .....   | 143        |
| Delete a Trail .....                                   | 143        |
| Edit a Trail Name .....                                | 144        |
| Edit a Trail Color .....                               | 144        |
| Edit a Trail Pattern.....                              | 144        |
| Utilities .....  | 145        |
| Alarm Clock .....                                      | 145        |
| Sun/Moon Rise & Set Calculator.....                    | 145        |
| Trip Calculator .....                                  | 145        |
| Trip Down Timer .....                                  | 145        |
| Trip Up Timer.....                                     | 145        |
| Waypoints .....  | 145        |
| Delete a Waypoint .....                                | 145        |
| Edit a Waypoint.....                                   | 146        |
| Selecting a Waypoint .....                             | 147        |
| Set a Waypoint by Average Position .....               | 148        |
| Set a Waypoint by Projecting a Position.....           | 148        |
| <b>Section 8: System &amp; GPS Setup Options .....</b> | <b>149</b> |
| Alarms.....  | 149        |
| Auto Satellite Search .....                            | 150        |
| Check MMC Files and Storage Space.....                 | 151        |
| Communications Port Configuration .....                | 151        |
| Configure NMEA.....                                    | 152        |
| Coordinate System Selection.....                       | 152        |
| Map Fix.....   | 154        |
| Customize Page Displays.....                           | 155        |
| GPS Simulator.....                                     | 156        |
| Hide GPS Feature .....                                 | 158        |
| Initialize GPS .....                                   | 158        |

|   |            |
|---|------------|
| Map Auto Zoom .....                               | 159        |
| Map Data .....                                    | 159        |
| Map Datum Selection.....                          | 161        |
| Map Detail Category Selection.....                | 162        |
| Map Orientation.....                              | 162        |
| NauticPath™ USA Marine Charts.....                | 164        |
| Nautical Chart Notes .....                        | 164        |
| Port Information.....                             | 165        |
| Tidal Current Information.....                    | 166        |
| Tide Information .....                            | 168        |
| Navionics® Charts .....                           | 169        |
| Overlay Data .....                                | 170        |
| Pop-up Help .....                                 | 174        |
| Reset Options.....                                | 175        |
| Screen Contrast and Brightness .....              | 176        |
| Set Language.....                                 | 177        |
| Set Local Time.....                               | 177        |
| Show WAAS Alarm .....                             | 178        |
| Software Version Information .....                | 179        |
| Sounds and Alarm Sound Styles .....               | 180        |
| Track Smoothing .....                             | 181        |
| Trail Options.....                                | 181        |
| Transparency.....                                 | 184        |
| Units of Measure .....                            | 185        |
| <b>Section 9: Searching.....</b>                  | <b>189</b> |
| Find Streets .....                                | 190        |
| Find Any Item Selected by Map Cursor .....        | 191        |
| Find Interstate Highway Exits .....               | 191        |
| Find Map Places or Points of Interest (POI) ..... | 194        |
| Find Streets or Intersections.....                | 196        |
| Find a Street.....                                | 196        |
| Find an Intersection.....                         | 197        |
| Find Waypoints .....                              | 199        |
| <b>Section 10: NMEA 2000 .....</b>                | <b>203</b> |
| NMEA 2000 Menu.....                               | 203        |
| Internal GPS Receiver .....                       | 203        |
| To switch from internal GPS to LGC module.....    | 203        |
| Bus Setup.....                                    | 204        |
| Engine & Tank Configuration .....                 | 205        |
| Tank Select .....                                 | 206        |
| Tank Size .....                                   | 206        |
| Set Configuration button .....                    | 206        |
| Device Configuration Menu.....                    | 207        |

|  |     |
|--|-----|
| Device Information and Device Data .....   | 207 |
| Fuel Management Menu.....                  | 208 |
| Tank Location .....                        | 208 |
| Fuel Added.....                            | 208 |
| Add Fuel.....                              | 209 |
| Fill Tank.....                             | 209 |
| Adding Fuel to Tank .....                  | 209 |
| Engine Operations.....                     | 209 |
| Engine Select .....                        | 209 |
| NMEA 2000 Alarms .....                     | 210 |
| Waypoint Sharing .....                     | 211 |
| Backlight Synchronization .....            | 211 |
| Configuring EP Sensors.....                | 212 |
| EP-35 Temperature Configuration .....      | 212 |
| Advanced Options menu .....                | 213 |
| Instance.....                              | 213 |
| Restore Defaults .....                     | 213 |
| To restore default settings.....           | 213 |
| EP-10 Fuel Flow Configuration.....         | 213 |
| Advanced Options menu .....                | 214 |
| Instance.....                              | 214 |
| Restore Defaults .....                     | 214 |
| EP-15 Fluid Level Configuration .....      | 215 |
| To input Device Name:.....                 | 215 |
| To select Tank Instance (Location): .....  | 215 |
| To select Fluid Type: .....                | 216 |
| To input Tank Size: .....                  | 216 |
| Advanced Options menu .....                | 217 |
| Instance.....                              | 217 |
| Restore Defaults .....                     | 217 |
| To restore default settings: .....         | 217 |
| Suzuki Engine Interface Configuration..... | 218 |
| Advanced Options menu .....                | 219 |
| Instance.....                              | 219 |
| Restore Defaults .....                     | 219 |
| To restore default settings: .....         | 219 |
| Calibrating EP Sensors.....                | 220 |
| EP-10 Fuel Flow Calibration.....           | 220 |
| To check fuel flow accuracy:.....          | 220 |
| To calibrate an EP-10 Fuel Flow:.....      | 221 |
| To Reset Calibration: .....                | 221 |
| EP-15 Fluid Level Calibration .....        | 221 |
| 2-Point Calibration.....                   | 221 |



|  |            |
|--|------------|
| 3-Point Calibration.....                       | 222        |
| 5-Point Calibration.....                       | 223        |
| Engine Trim Calibration.....                   | 225        |
| Reset Trim Calibration .....                   | 226        |
| Bennett Trim Tabs Calibration.....             | 226        |
| To calibrate Trim Tabs:.....                   | 226        |
| To Reset Calibration: .....                    | 227        |
| <b>Section 11: Supplemental Material .....</b> | <b>229</b> |

## ***NOTICE!***

The storage and operation temperature range for your unit is from -20 degrees to +167 degrees Fahrenheit (-28 degrees to +75 degrees Celsius). *Extended storage or operation in temperatures higher or lower than specified will damage the liquid crystal display in your unit. This type of damage is not covered by the warranty.* For more information, contact the factory's Customer Service Department; phone numbers are listed on the last page of the manual.

## **WARNING!**

**A CAREFUL NAVIGATOR NEVER RELIES ON ONLY ONE METHOD TO OBTAIN POSITION INFORMATION.**

## ***CAUTION***

*When showing navigation data to a position (waypoint), a GPS unit will show the shortest, most direct path to the waypoint. It provides navigation data to the waypoint regardless of obstructions. Therefore, the prudent navigator will not only take advantage of all available navigation tools when traveling to a waypoint, but will also visually check to make sure a clear, safe path to the waypoint is always available.*

## **WARNING!**

**When a GPS unit is used in a vehicle, the vehicle operator is solely responsible for operating the vehicle in a safe manner. Vehicle operators must maintain full surveillance of all pertinent driving, boating or flying conditions at all times. An accident or collision resulting in damage to property, personal injury or death could occur if the operator of a GPS-equipped vehicle fails to pay full attention to travel conditions and vehicle operation while the vehicle is in motion.**

# Section 1: Read Me First!

## *How this manual can get you out on the road, fast!*

Welcome to the exciting world of digital sonar and GPS! We know you're anxious to begin navigating and finding fish, but we have a favor to ask. Before you grab the unit and begin installing it, please give us a moment or two to explain how our manual can help you get the best performance from your compact, wide-screen, combination fish finder and mapping GPS receiver.

First, we want to thank you for buying a Lowrance sonar/GPS unit. Whether you're a first time user or a professional fisherman, you'll discover that your unit is easy to use, yet capable of handling demanding navigation and sonar tasks. When you team your unit with our custom mapping software MapCreate™ 6, you have an incredible combination. You won't find another combination GPS and sonar unit with this much power and this many features for this price!

Our goal for this book is to get you on the water fast, with a minimum of fuss. Like you, we'd rather spend more time boating or fishing and less time reading the manual!

So, we designed our book so that you *don't* have to read the *whole thing* from front to back for the information you want. At the start (or end) of each segment, we'll tell you what content is coming up next. If it's a concept you're already familiar with, we'll show you how and where to skip ahead for the next important topic. We've also made it easy to look up any tips you may need from time to time. Here's how:

The manual is organized into 10 sections. This first section is an introduction to the LMS-522c iGPS and LMS-527cDF iGPS. It tells you the basics you need to know before you can make the unit look around and tell you where you are, or look below the surface to find some fish.

Section 2 will help you install your unit, the transducer and the GPS antenna module. We'll show you how to get the MultiMedia Card (MMC) correctly installed inside the unit. We'll also tell you about some of the available accessories.

Section 3 covers *Basic Sonar Operation*. It will show you how easy it is to run your sonar, right out of the box. This section features a one-page Sonar Quick Reference. **(If you've already jumped ahead and figured out how to install the unit yourself, and you just *can't* wait any longer, turn to the Quick Reference on page 51 and head for the water!)**

After you have gained some experience with your sonar, you'll want to check out Section 4, which discusses more advanced *Sonar Options and Other Features*.

When you come to a sonar menu command on your unit's screen, you can look it up in the manual by skimming over the table of contents, just flipping through Section 3 or scanning through the sonar options in Section 4.

If you're having difficulty with your sonar, you can find an answer to the most common problems in Section 5, *Sonar Troubleshooting*.

The manual switches from sonar to navigation in Section 6, which introduces you to *Basic GPS Operations*. **This section features a one-page GPS Quick Reference on page 117.**

Section 6 contains short, easy-to-scan GPS lessons that follow one another in chronological order. They're all you'll need to know to find your way on the water quickly.

After you've learned the basics (or if you already have some GPS experience), you may want to try out some of the unit's many advanced navigation features. That brings us to Section 7, *Advanced GPS Operations*. This section contains the rest of your unit's GPS command functions.

When you come to a GPS menu command on the screen, you can look it up in the manual by skimming over the table of contents, flipping through Section 6 or scanning the command portion of Section 7.

Your unit is ready to use right out of the box, but you can fine tune and customize it's operation with dozens of options. Since sonar is the unit's key feature, we put the main sonar options in Section 4. Some options, such as screen brightness settings, affect both sonar and GPS operations. We describe how to use those common options along with GPS options in Section 8, *System Setup and GPS Setup Options*.

In Section 9, we go into more detail on one of the unit's most remarkable GPS capabilities — Searching. We'll introduce a search example in the Basic GPS Operation section, but there are so many map items you can search for, we had to give this function it's own section in the manual! For example, did you know your unit can look up business phone numbers, functioning as a virtual Yellow Pages? We'll show you how in Section 9.

Finally, in Section 10, we offer *Supplemental Material*, including a list of the GPS datums used, warranties and customer service information.

Now, if you're into the fine details, glance over the next segment on specifications to see just how much sonar and GPS power your unit contains.

It's important to *us* (and our power users), but, if *you* don't care how many watts of power the unit has, or how many waypoints the your unit can store, skip ahead to important information on how the sonar works, on page 5. (Background on GPS begins on page 6.)

**Specifications: LMS-522c iGPS and LMS-527cDF iGPS**  
**General**

- Display:** ..... 5.0" (12.7 cm) diagonal high contrast color Film SuperTwist LCD; programmable to viewing preference.
- Resolution:** ..... 480 pixel x 480 pixel resolution; 230,400 total pixels.
- Backlighting:** ..... Incandescent backlit screen with multiple lighting levels; backlit keypad.
- Input power:** ..... 10 to 15 volts DC.
- Case size:** ..... 5.4" H x 6.9" W x 3.4" D (13.8 x 17.6 x 8.6 cm); sealed and waterproof; suitable for salt-water use.
- MMC slots:** ..... One with waterproof door (SD card compatible).
- Recording:** ..... GPS uses MMC & SD cards for recording trip details and displaying charts or custom maps. Sonar uses them to record and save sonar chart logs.
- Back-up memory:** ..... Built-in memory stores sonar records and GPS data for decades. User settings are stored when unit is turned off.
- Languages:** ..... 10; menu languages selectable by user.

**Sonar**

- Frequency:** ..... **LMS-527cDF:** 50/200 kHz.  
**LMS-522c:** 200 kHz.
- Transducers:** ..... A dual-frequency Skimmer<sup>®</sup> transducer with built-in temperature sensor is packed with the LMS-527cDF. It has 35°/12° cone angles. A single-frequency Skimmer transducer with built-in temperature sensor is packed with the LMS-522c. It has a 20° cone angle. Transducers operate at speeds up to 70 mph (61 kts).

**Transmitter:**.....3,000 watts peak-to-peak/375 watts RMS.

**Sonar sounding**

**depth capability:**.....**LMS-527cDF:** 2,500 feet/762 meters.  
**LMS-522c:** 1,000 feet/305 meters.  
(Actual capability depends on transducer configuration and installation, bottom composition and water conditions. All sonar units typically read deeper in fresh water than in salt water.)

**Depth display:** ..... Continuous display.

**Graph recording:**..... Up to 1 GB on one MMC (or SD) card

**Audible alarms:**..... Deep/shallow/fish/zone.

**Automatic ranging:** ..... Yes, with instant screen updates.

**Auto bottom track:** ..... Yes

**Zoom bottom track:**..... Yes.

**Split-screen zoom:** ..... Yes.

**Surface water temp:** ..... Yes, built into transducer.

**Speed/distance log:** ..... Yes, with optional speed sensor (sensor included with LMS-527cDF.)

**GPS**

**Receiver/antenna:**.....Internal; Built in 12 parallel channel NMEA 2000-ready GPS/WAAS receiver/antenna.

**Background map:** ..... Built-in custom, detailed Lowrance map. Contains: enhanced detail of continental U.S. and Hawaii. Includes more than 60,000 nav aids and 10,000 wrecks/obstructions in coastal and Great Lakes waters. Metro areas, selected major streets/highways and interstate exit services details included.

**Custom mapping:**.....MapCreate™ 6 software optional; optional plug and play LEI FreedomMaps™ offer the same high-detail without the computer work of MapCreate. Other plug and play mapping options include IMS™ Fishing Hot Spots®, LEI NauticPaths™ charts and Navionics® charts.

- Mapping memory:** .....Up to 1 GB on one MMC (or SD) card.
- Position updates:**.....Every second.
- Position points:**.....1,000 waypoints; 1,000 event marker icons.
- Audible alarms:**.....Arrival/off-course/anchor.
- Graphic symbols for waypoints or event marker icons:**.....42.
- Routes:** .....100; up to 100 waypoints per route.
- Plot Trails:**.....10 savable; up to 9,999 points per trail.
- Zoom range:** .....39 ranges; 0.02 to 4,000 miles.

**NOTE:**

The above memory capacities refer only the unit’s on-board memory. The amount of GPS or sonar data you can record and save for recall later is only limited by the number of MMC cards you have.

*NOTICE!*

The storage temperature range for your unit is from -4 degrees to +167 degrees Fahrenheit (-20 degrees to +75 degrees Celsius). *Extended storage in temperatures higher or lower than specified will damage the liquid crystal display in your unit. This type of damage is not covered by the warranty.* For more information, contact the factory's Customer Service Department; phone numbers are listed on the last page.

**How Lowrance Sonar Works**

Sonar has been around since the 1940s, so if you already know how it works, skip down to read about the relatively new technology of GPS. But, if you've never owned a sonar fish finder, this segment will tell you the under water basics.

Sonar is an abbreviation for Sound Navigation and Ranging, a technology developed during World War II for tracking enemy submarines. (Lowrance developed the world's *first* transistorized *sportfishing* sonar in 1957.) A sonar consists of a transmitter, transducer, receiver and display. In simple terms, here's how it finds the bottom, or the fish:

The transmitter emits an electrical impulse, which the transducer converts into a sound wave and sends into the water. (The sound frequency can't be heard by humans or fish.) The sound wave strikes an object (fish, structure, bottom) and bounces back to the transducer, which converts the sound back into an electrical signal.

The receiver amplifies this return signal, or echo, and sends it to the display, where an image of the object appears on the scrolling sonar chart. The sonar's microprocessor calculates the time lapse between the transmitted signal and echo return to determine the distance to the object. The whole process repeats itself several times each second.

Your unit can record a log of the sonar signals that scroll across the screen and save them to the MMC memory card. (These recordings are also called sonar charts or sonar graphs.) You can replay this sonar log in the unit using the Sonar Simulator function, or play it back on a personal computer using our free Sonar Viewer. The viewer is available for download from the Lowrance web site, [www.lowrance.com](http://www.lowrance.com).

You can save several different sonar log files, erase 'em and record new ones, over and over again. The size of your sonar recordings is only limited by the free space available on your MMC.

## **How Lowrance GPS Works**

You'll navigate faster and easier if you understand how your unit scans the sky to tell you where you are on the earth — and, where you're going. (But if you already have a working understanding of GPS receivers and the GPS navigation system, skip ahead to Section 2, *Installation & Accessories* on page 13. If you're new to GPS, read on, and you can later impress your friends with your new-found knowledge.)

First, think of your unit as a small but powerful computer. (But don't worry — we made the unit easy to use, so you don't need to be a computer expert to find your way!) It includes a keypad and a screen with menus so you can tell it what to do. The screen also lets the unit show your location on a moving map, as well as point the way to your destination.

This gimbal-mounted unit uses an external antenna/receiver module, which makes the whole system work something like your car radio. But instead of your favorite dance tunes, this receiver tunes in to a couple of dozen GPS satellites circling the earth. (It will also listen in to the WAAS satellites in orbit, but more about that in the upcoming segment introducing you to GPS and WAAS.)

Your unit listens to signals from as many satellites as it can "see" above the horizon, eliminates the weakest signals, then computes its location in relation to those satellites. Once the unit figures its latitude and longitude, it plots that position on the moving map shown on the screen. The whole process takes place several times a second!



The performance doesn't stop there. Stored in the permanent memory of each unit is a basic background map of the *entire* world. We lock it in here at the factory — you can't change or erase this map.

The background map is suitable for many navigation chores, but for maximum accuracy and much more detail, you need our optional map-making software, MapCreate™ 6. Some unit features — such as searching for businesses and addresses — won't work without a custom MapCreate map. There is so much detail in our background map (and even more in MapCreate) that we'll describe their contents and differences in Section 6, *Basic GPS Operations*, on page 101.

Another portion of the unit's onboard memory is devoted to *recording* GPS navigation information, which includes waypoints, event marker icons, trails and routes. This lets you look back the way you came. Think of this data storage like the hard drive memory in a computer or a tape in a cassette tape recorder. You can save several different GPS data files, erase 'em and record new ones, over and over again.

Your unit has one more thing in common with a personal computer. Just as computers have a floppy disk drive for storing and exchanging files, the unit has a slot for an MMC (MultiMedia Card) or SDC (Secure Digital card) flash memory card. These solid-state memory devices are about the size of a postage stamp, but can hold data ranging from 8 MB to 1 GB. (Compare that to a floppy disk's 1.44 MB capacity!) Your unit uses all that MMC space for two key GPS purposes. (The MMC is also used to record sonar logs.)

First, you can backup your onboard GPS Data Files by copying them to the MMC. Since the MMC is removable (like a floppy disk or a cassette tape), you can store these GPS Data Files on a personal computer equipped with an MMC card reader. (Or store them on a pocketful of MMCs, if you don't have a computer.) Our MapCreate mapping software can save, edit or create its own GPS Data Files, which can be copied to the MMC and then loaded from the MMC into unit's memory. (**NOTE:** No matter where they come from, GPS Data Files *must* be loaded from the MMC into memory before your unit can use them.)

The other key GPS use for MMCs is storage of special high-detail, custom maps, which you can produce on your computer with our MapCreate software. These MapCreate custom maps contain much greater detail than the basic background map. These **Custom Map Files** (file format \*.lcm) not only may be shared between the LMS-522c and 527cDF, but also with other Lowrance GPS and sonar/GPS units as well as personal computers. (For example, the exact same MMC, cus-

tom map files and GPS data files can be used interchangeably between your gimbal-mounted unit and the hand-held iFINDER™ GPS receiver.)

Your unit automatically reads Custom Map Files directly from the MMC or SDC. To use a custom map, all you need to do is slide an MMC containing a map into the unit.

## **Introduction to GPS and WAAS**

Well, now you know the basics of how your unit does its work. You might be ready to jump ahead to Section 2, *Installation & Accessories*, on page 13, so you can mount your unit and plug in the power. Or you might want to see how our text formatting makes the manual tutorials easy to skim. If that's the case, move on to "How to Use This Manual" on page 10. But, if you want to understand the current state of satellite navigation, look over this segment describing how GPS and its new companion WAAS work together to get you where you're going.

The Global Positioning System (GPS) was launched July 17, 1995 by the United States Department of Defense. It was designed as a 24-hour-a-day, 365-days-a-year, all weather global navigation system for the armed forces of the U.S. and its allies. Civilian use was also available at first, but it was less accurate because the military scrambled the signal somewhat, using a process called Selective Availability (SA.)

GPS proved so useful for civilian navigation that the federal government discontinued SA on May 2, 2000, after the military developed other methods to deny GPS service to enemy forces. Reliable accuracy for civilian users jumped from 100 meters (330 feet) under SA to the present level of 10 to 20 meters (about 30 to 60 feet.)

Twenty-four satellites orbit 10,900 nautical miles above the Earth, passing overhead twice daily. A series of ground stations (with precisely surveyed locations) controls the satellites and monitors their exact locations in the sky. Each satellite broadcasts a low-power signal that identifies the satellite and its position above the earth. Three of these satellites are spares, unused until needed. The rest virtually guarantee that at least four satellites are in view nearly anywhere on Earth at all times.

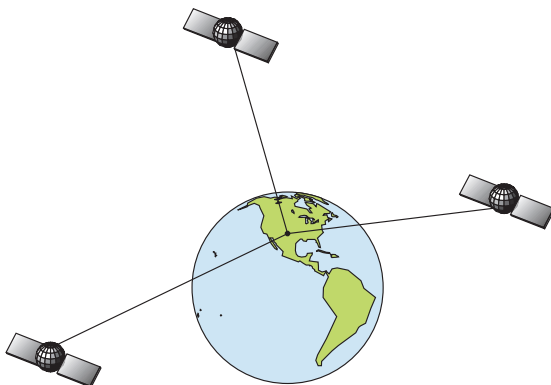

**A minimum of three satellites are required to determine a 2D fix.**

The system requires signal reception from three satellites in order to determine a position. This is called a 2D fix. It takes four satellites to determine both position and elevation (your height above sea level — also called altitude.) This is called a 3D fix.

Remember, the unit must have a clear view of the satellites in order to receive their signals. Unlike radio or television signals, GPS works at very high frequencies. These signals can be easily blocked by trees, buildings, an automobile roof, even your body.

Like most GPS receivers, the unit doesn't have a compass or any other navigation aid built inside. It relies solely on the signals from the satellites to calculate a position. Speed, direction of travel, and distance are all calculated from position information. Therefore, in order it to determine direction of travel, you must be moving and the faster, the better. This is not to say that it won't work at walking or trolling speeds — it will. There will simply be more "wandering" of the data shown on the display.

GPS alone is plenty accurate for route navigation, but the U.S. Federal Aviation Administration has special aircraft navigation needs that go beyond basic GPS. So, the FAA has developed a program to boost GPS performance with its Wide Area Augmentation System, or WAAS. The FAA commissioned the system on July 11, 2003.

WAAS is designed to increase GPS accuracy to within 7.6 meters vertically and horizontally, but it consistently delivers accuracies within 1-2 meters horizontal and 2-3 meters vertical, according to the FAA. It does this by broadcasting correction signals on GPS frequencies. Your unit automatically receives both GPS and WAAS signals.

However, there are some fringe areas of the U.S., including parts of Alaska, that do not yet receive robust WAAS coverage. Continued WAAS development is planned to extend WAAS coverage in the years to come.

WAAS boosts the accuracy of land GPS navigation, but the system is designed for aircraft. The satellites are in a fixed orbit around the Equator, so they appear very low in the sky to someone on the ground in North America. Aircraft and vessels on open water can get consistently good WAAS reception, but terrain, foliage or even large man-made structures can sometimes block the WAAS signal from ground receivers.

You'll find that using your GPS receiver is both easy and amazingly accurate. It's easily the most accurate method of electronic navigation available to the general public today. Remember, however, that this receiver is only a tool. Always have another method of navigation available, such as a map or chart and a compass.

Also remember that this unit will always show navigation information in the shortest line from your present position to a waypoint, regardless of terrain! It only calculates position, it can't know what's between you and your destination, for example. It's up to you to safely navigate around obstacles, no matter how you're using this product.

## **How to use this manual: typographical conventions**

Many instructions are listed as numbered steps. The keypad and arrow "keystrokes" appear as boldface type. So, if you're in a real hurry (or just need a reminder), you can skim the instructions and pick out what menu command to use by finding the boldface command text. The following paragraphs explain how to interpret the text formatting for those commands and other instructions:

### **Arrow Keys**

The arrow keys control the movement of dotted crosshairs lines on your mapping screen called the cursor. The arrow keys also control a horizontal line depth cursor on the sonar screen. The arrow keys help you move around the menus so you can execute different commands. They are represented by symbols like these, which denote the down arrow key, the up arrow, the left arrow and the right arrow: ↓ ↑ ← →.

## Keyboard

The other keys perform a variety of functions. When the text refers to a key to press, the key is shown in bold, sans serif type. For example, the "Enter/Icons" key is shown as **ENT** and the "Menu" key is shown as **MENU**.

## Menu Commands

A menu command or a menu option will appear in small capital letters, in a bold sans serif type like this: **ROUTE PLANNING**. These indicate that you are to select this command or option from a menu or take an action of some kind with the menu item. Text that you may need to enter or file names you need to select are shown in italic type, such as *trail name*.

## Instructions = Menu Sequences

Most functions you perform with your unit are described as a sequence of key strokes and selecting menu commands. We've written them in a condensed manner for quick and easy reading.

For example, instructions for navigating a trail would look like this:

1. From the Map Page, press **MENU | MENU | ↓** to **MY TRAILS | ENT**.
2. Press **↓** to *Trail 1* | **ENT** | **→** | **↓** to **NAVIGATE | ENT**.
3. You are asked to wait while it converts the trail into a route.
4. The wait message disappears and the unit begins showing navigation information along the trail..

Translated into complete English, step 1 above would mean: "Start on the Map Page. Press the Menu key twice. Next, repeatedly press (or press and hold) the down arrow key to scroll down the menu and select (highlight) the My Trails menu command. Finally, press the Enter key."

Step 2 would mean: "Press the down arrow key repeatedly to scroll to the trail named Trail 1, and press Enter. Next, press the right arrow key and then the down arrow key to highlight the Navigate command, then press Enter."

# Notes

# Section 2: Installation

## Preparations

You can install the sonar and GPS systems in some other order if you prefer, but we recommend this installation sequence:

### **Caution:**

*You should read over this entire installation section before drilling any holes in your vehicle or vessel!*

1. Determine the approximate location for the sonar/GPS unit, so you can plan how and where to route the cables for the antenna, transducer and power. This will help you make sure you have enough cable length for the desired configuration.
2. Determine the approximate location for the transducer and its cable route.
3. Determine the approximate location for the GPS antenna module and its cable route.
4. Determine the location of your battery or other power connection, along with the power cable route.
5. Install the transducer and route the transducer cable to the sonar/GPS unit.
6. Install the GPS antenna and route the antenna cable to the sonar/GPS unit.
7. Install the power cable and route it to the sonar/GPS unit.
8. Mount the sonar/GPS unit to the bracket.

## Transducer Installation

These instructions will help you install your Skimmer<sup>®</sup> transducer on a transom, on a trolling motor or inside a hull. These instructions cover both single- and dual-frequency Skimmer transducers. Please read all instructions before proceeding with any installation.

The smaller single-frequency Skimmers typically use a one-piece, stainless steel mounting bracket. The larger dual-frequency Skimmers typically use a two-piece, plastic mounting bracket. The trolling motor mount uses a one-piece plastic bracket with an adjustable strap.

These are all "kick-up" mounting brackets. They help prevent damage if the transducer strikes an object while the boat is moving. If the transducer does "kick-up," the bracket can easily be pushed back into place without tools.

Read these instructions carefully *before* attempting the installation. Determine which of the mounting positions is right for your boat. ***Remember, the transducer installation is the most critical part of a sonar installation.***

**NOTE:**

The following installation types also call for these recommended tools and required supplies that you must provide (supplies listed here are *not* included):

**Single-frequency transom installations**

Tools include: two adjustable wrenches, drill, #29 (0.136") drill bit, flat-head screwdriver. Supplies: *high quality, marine grade* above- or below-waterline sealant/adhesive compound.

**Dual-frequency transom installations**

Tools: two adjustable wrenches, drill, #20 (0.161") drill bit, flat-head screwdriver. Supplies: four, 1" long, #12 stainless steel slotted wood screws, *high quality, marine grade* above- or below-waterline sealant/adhesive compound.

**Single-frequency trolling motor installations**

Tools: two adjustable wrenches, flat-head screwdriver. Supplies: plastic cable ties.

**Shoot-through hull installations**

Tools: these will vary depending on your hull's composition. Consult your boat dealer or manufacturer. Other tools are a wooden craft stick or similar tool for stirring and applying epoxy, and a paper plate or piece of cardboard to mix the epoxy on. Supplies: rubbing alcohol, 100 grit sandpaper, specially formulated epoxy adhesive available from LEI (see ordering information on the inside back cover). A sandwich hull also requires polyester resin.

**Selecting a Transducer Location**

1. The location must be in the water at all times, at all operating speeds.
2. The transducer must be placed in a location that has a *smooth flow* of water at all times. If the transducer is not placed in a smooth flow of water, interference caused by bubbles and turbulence will show on the sonar's display in the form of random lines or dots whenever the boat is moving.

**NOTE:**

Some aluminum boats with strakes or ribs on the outside of the hull create large amounts of turbulence at high speed. These boats typically have large outboard motors capable of propelling the boat



at speeds faster than 35 mph. Typically, a good transom location on aluminum boats is between the ribs closest to the engine.

- The transducer should be installed with its face pointing straight down, if possible. *For shoot-thru applications:* Many popular fishing boat hulls have a flat keel pad that offers a good mounting surface. On vee hulls, try to place the transducer where the deadrise is 10° or less.

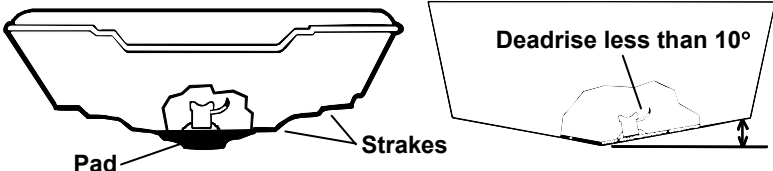

Left, vee pad hull; right, vee hull. A pod style transducer is shown here, but the principle is the same for Skimmers inside a hull.

- If the transducer is mounted on the transom, make sure it doesn't interfere with the trailer or hauling of the boat. Also, don't mount it closer than approximately one foot from the engine's lower unit. This will prevent cavitation (bubble) interference with propeller operation.
- If possible, route the transducer cable away from other wiring on the boat. Electrical noise from engine wiring, bilge pumps and aerators can be displayed on the sonar's screen. Use caution when routing the transducer cable around these wires.

**CAUTION:** Clamp the transducer cable to transom near the transducer. This will help prevent the transducer from entering the boat if it is knocked off at high speed.

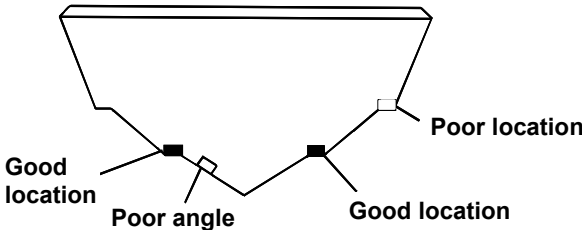
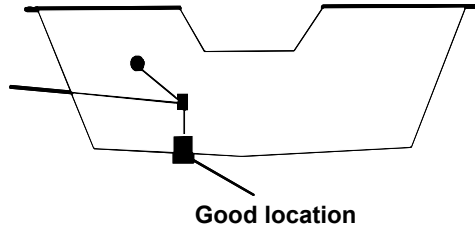

Good and poor transducer locations.

### How low should you go?

For most situations, you should install your Skimmer transducer so that its centerline is level with the bottom of the boat hull.

This will usually give you the best combination of smooth water flow and protection from bangs and bumps.

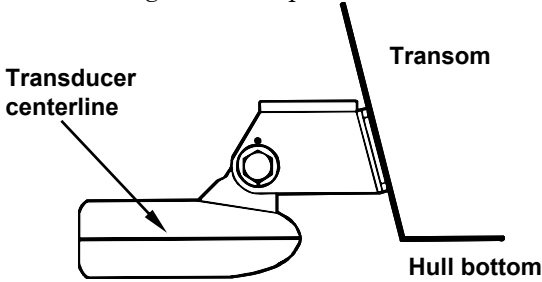

**Align transducer centerline with hull bottom.**

However, there are times when you may need to adjust the transducer slightly higher or lower. (The slots in the mounting brackets allow you to loosen the screws and slide the transducer up or down.) If you frequently lose bottom signal lock while running at high speed, the transducer may be coming out of the water as you cross waves or wakes. Move the transducer a little lower to help prevent this.

If you cruise or fish around lots of structure and cover, your transducer may be frequently kicking up from object strikes. If you wish, you may move the transducer a little higher for more protection.

There are two extremes you should avoid. Never let the edge of the mounting bracket extend below the bottom of the hull. Never let the bottom – the face – of the transducer rise above the bottom of the hull.

**Shoot-thru-hull vs. Transom Mounting**

In a shoot-thru-hull installation, the transducer is bonded to the *inside* of the hull with epoxy. The sonar "ping" signal actually passes through the hull and into the water. This differs from a bolt-thru-hull installation (often called simply "thru-hull"). In that case, a hole is cut in the hull and a specially designed transducer is mounted *through* the hull with a threaded shaft and nut. This puts the transducer in direct contact with the water.

Typically, shoot-thru-hull installations give excellent high speed operation and good to excellent depth capability. There is no possibility of transducer damage from floating objects, as there is with a transom-mounted transducer. A transducer mounted inside the hull can't be knocked off when docking or loading on a trailer.

However, the shoot-thru-hull installation does have its drawbacks. First, some loss of sensitivity does occur, even on the best hulls. This varies from hull to hull, even from different installations on the same hull. This is caused by differences in hull lay-up and construction.

Second, the transducer angle cannot be adjusted for the best fish arches on your sonar display. (This is not an issue for flasher-style sonars.) Lack of angle adjustment can be particularly troublesome on hulls that sit with the bow high when at rest or at slow trolling speeds.

Third, a transducer **CAN NOT** shoot through wood and metal hulls. Those hulls require either a transom mount or a thru-hull installation.

Fourth, if your Skimmer transducer has a built in temp sensor, it will only show the temperature of the bilge, not the water surface temp.

Follow the testing procedures listed in the shoot-thru-hull installation section at the end of this lesson to determine if you can satisfactorily shoot through the hull.

### Transom Transducer Assembly And Mounting

The best way to install these transducers is to loosely assemble all of the parts first, place the transducer's bracket against the transom and see if you can move the transducer so that it's parallel with the ground.

The following instructions sometimes vary depending on the mounting bracket that came with your transducer. Single-frequency Skimmers come with a one-piece stainless steel bracket, while dual-frequency Skimmers come with a two-piece plastic mounting bracket. Use the set of instructions that fits your model.

#### 1. Assembling the bracket.

**A. One-piece bracket:** Press the two small plastic ratchets into the sides of the metal bracket as shown in the following illustration. Notice there are letters molded into each ratchet. Place each ratchet into the bracket with the letter "A" aligned with the dot stamped into the metal bracket. This position sets the transducer's coarse angle adjustment for a 14° transom. Most outboard and stern-drive transoms have a 14° angle.

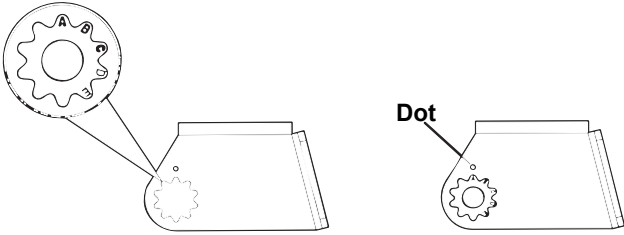

Align plastic ratchets in bracket.

**B. Two-piece bracket:** Locate the four plastic ratchets in the transducer's hardware package. Press two ratchets into the sides of the plastic bracket and two on either side of the transducer as shown in the following illustrations. Notice there are letters molded into each ratchet.

Place the ratchets into the bracket with the letter "A" aligned with the alignment mark molded into the bracket. Place the ratchets onto the transducer with the letter "A" aligned with the 12 o'clock position on the transducer stem. These positions set the transducer's coarse angle adjustment for a 14° transom. Most outboard and stern-drive transoms have a 14° angle.

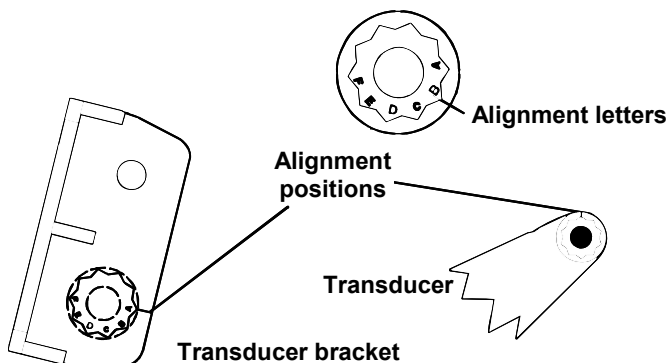

Insert and align ratchets.

Transducer bracket

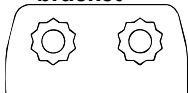

Transducer

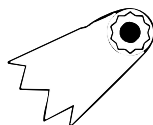

Ratchet

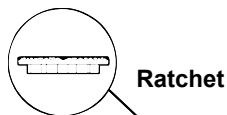

Ratchet

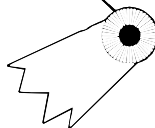
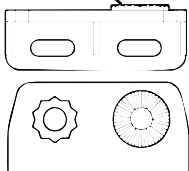

Add ratchets to bracket and transducer.

## 2. Aligning the transducer on the transom.

**A. One-piece bracket:** Slide the transducer between the two ratchets. Temporarily slide the bolt through the transducer assembly and hold it against the transom. Looking at the transducer from the side, check to see if it will adjust so that its face is parallel to the ground. If it does, then the "A" position is correct for your hull.

If the transducer's face isn't parallel with the ground, remove the transducer and ratchets from the bracket. Place the ratchets into the holes in the bracket with the letter "B" aligned with the dot stamped in the bracket.

Reassemble the transducer and bracket and place them against the transom. Again, check to see if you can move the transducer so it's parallel with the ground. If you can, then go to step 3A. If it doesn't, repeat step 2A, but use a different alignment letter until you can place the transducer on the transom correctly.

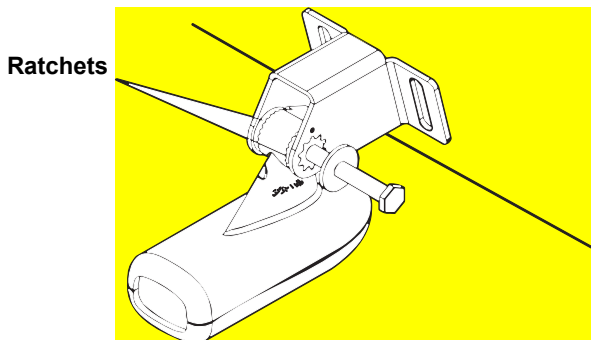

**Insert bolt and check transducer position on transom.**

**B. Two-piece bracket:** Assemble the transducer and bracket as shown in the following figure. Temporarily slide the bolt through the transducer assembly but don't tighten the nut at this time. Hold the assembled transducer and bracket against the transom. Looking at the transducer from the side, check to see if it will adjust so that its face is parallel to the ground. If it does, then the "A" positions are correct for your hull.

If the transducer's face isn't parallel with the ground, remove and disassemble the transducer and ratchets. Place the ratchets into the bracket holes with the letter "B" aligned with the bracket alignment mark. Place them on the transducer aligned with the 12 o'clock position on the transducer stem.

Reassemble the transducer and bracket and place them against the transom. Again, check to see if you can move the transducer so it's parallel with the ground. If you can, then go to step 3B. If it doesn't, repeat step 2B, but use a different alignment letter until you can place the transducer on the transom correctly.

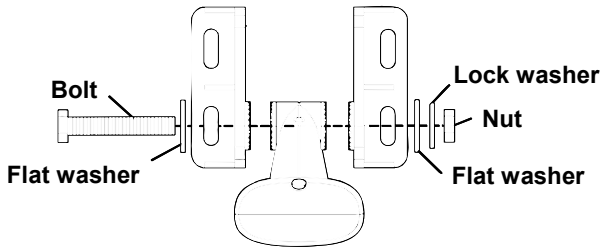

Assemble transducer and bracket.

### 3. Assembling the transducer.

**A. One-piece bracket:** Once you determine the correct position for the ratchets, assemble the transducer as shown in the following figure. Don't tighten the lock nut at this time.

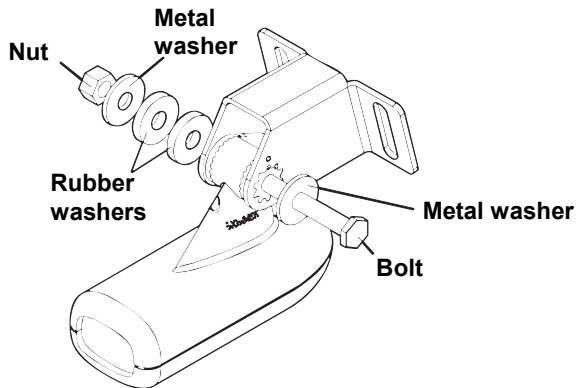

Assemble transducer and bracket.

**B. Two-piece bracket:** Once you determine the correct position for the ratchets, assemble the transducer as shown in the figure in step 2B. Don't tighten the lock nut at this time.

### 4. Drilling mounting holes.

Hold the transducer and bracket assembly against the transom. The transducer should be roughly parallel to the ground. The transducer's centerline should be in line with the bottom of the hull. Don't let the bracket extend below the hull!

Mark the center of each slot for the mounting screw pilot holes. You will drill one hole in the center of each slot.

Drill the holes. For the one-piece bracket, use the #29 bit (for the #10 screws). For the two-piece bracket, use the #20 bit (for the #12 screws).

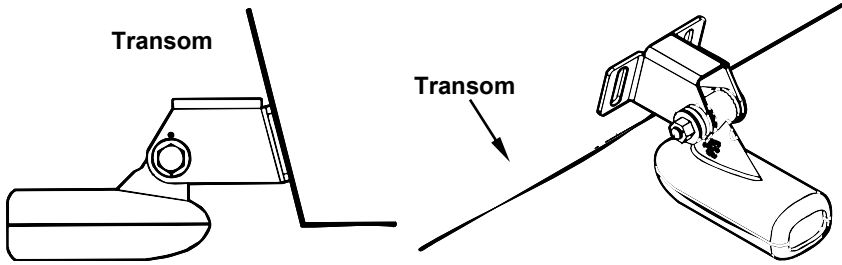

Position transducer mount on transom and mark mounting holes.  
Side view shown, left, and seen from above at right.

## 5. Attaching transducer to transom.

**A. One-piece bracket:** Remove the transducer from the bracket and re-assemble it with the cable passing through the bracket over the bolt as shown in the following figures.

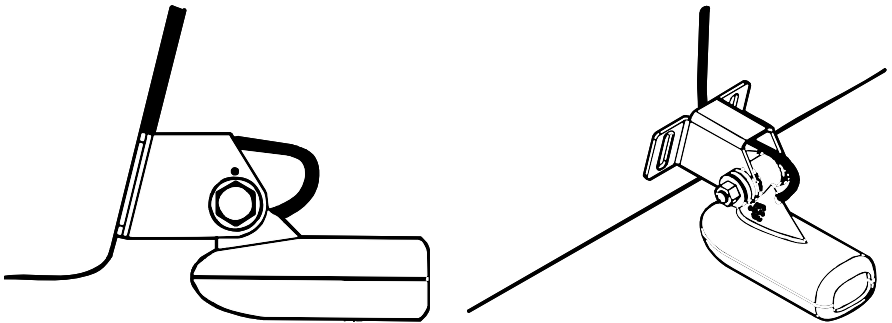

For single-frequency Skimmer, route cable over bolt and through bracket. Side view shown, left, and seen from above at right.

**Both bracket types:** Attach the transducer to the transom. Slide the transducer up or down until it's aligned properly with the bottom of the hull as shown in the preceding and following figures. Tighten the bracket's mounting screws, sealing them with the sealant.

Adjust the transducer so that it's parallel to the ground and tighten the nut until it touches the outer washer, then add 1/4 turn. *Don't over tighten the lock nut!* If you do, the transducer won't "kick-up" if it strikes an object in the water.

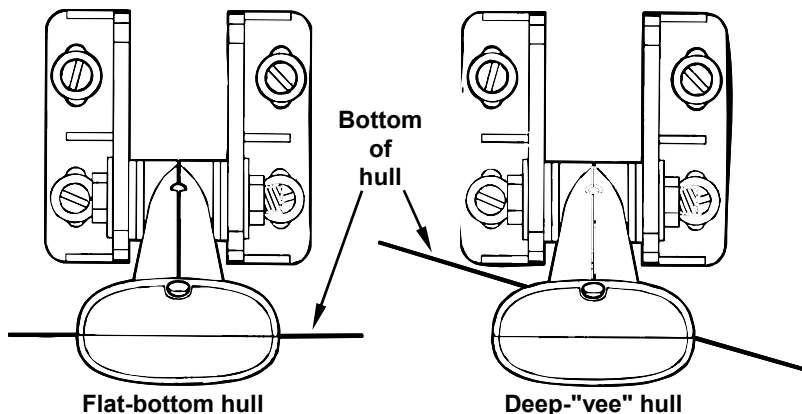

**Align transducer centerline with hull bottom and attach transducer to transom. Rear view of dual-frequency Skimmer shown.**

6. Route the transducer cable through or over the transom to the sonar unit. Make sure to leave some slack in the cable at the transducer. If possible, route the transducer cable away from other wiring on the boat. Electrical noise from the engine's wiring, bilge pumps, VHF radio wires and cables, and aerators can be picked up by the sonar. Use caution when routing the transducer cable around these wires.

**WARNING:**

**Clamp the transducer cable to the transom close to the transducer. This can prevent the transducer from entering the boat if it is knocked off at high speed.**

If you need to drill a hole in the transom to pass the connector through, the required hole size be 1".

**Caution:**

*If you drill a hole in the transom for the cable, make sure it is located above the waterline. After installation, be sure to seal the hole with the same marine grade above- or below-waterline sealant used for the mounting screws.*

7. **Make a test run to determine the results.** If the bottom is lost at high speed, or if noise appears on the display, try sliding the transducer bracket down. This puts the transducer deeper into the water, hopefully below the turbulence causing the noise. Don't allow the transducer bracket to go below the bottom of the hull!



## Trolling Motor Bracket Installation (single-frequency only)

1. Attach the optional TMB-S bracket to the transducer as shown in the following figure, using the hardware supplied with the transducer. (Note: The internal tooth washer is supplied with the TMB-S.)

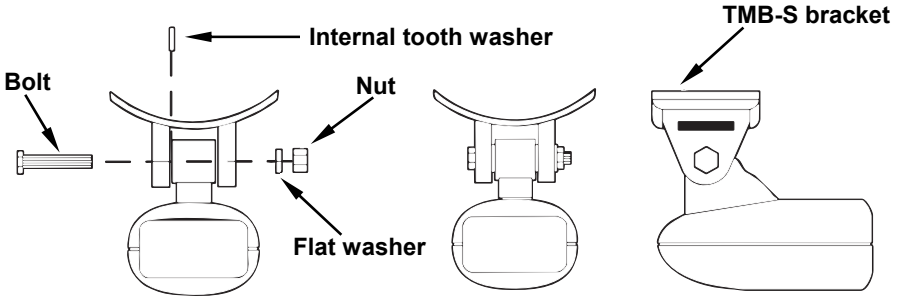

**Attach motor mounting bracket to transducer.**

2. Slide the adjustable strap supplied with the TMB-S through the slot in the transducer bracket and wrap it around the trolling motor. Position the transducer to aim straight down when the motor is in the water. Tighten the strap securely.
3. Route the transducer cable alongside the trolling motor shaft. Use plastic ties (not included) to attach the transducer cable to the trolling motor shaft. Make sure there is enough slack in the cable for the motor to turn freely. Route the cable to the sonar unit and the transducer is ready for use.

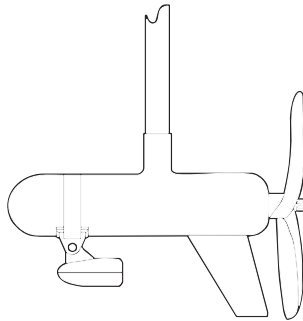

**Transducer mounted on trolling motor, side view.**

## Transducer Orientation and Fish Arches

If you do not get good fish arches on your display, it could be because the transducer is not parallel with the ground when the boat is at rest in the water or at slow trolling speeds.

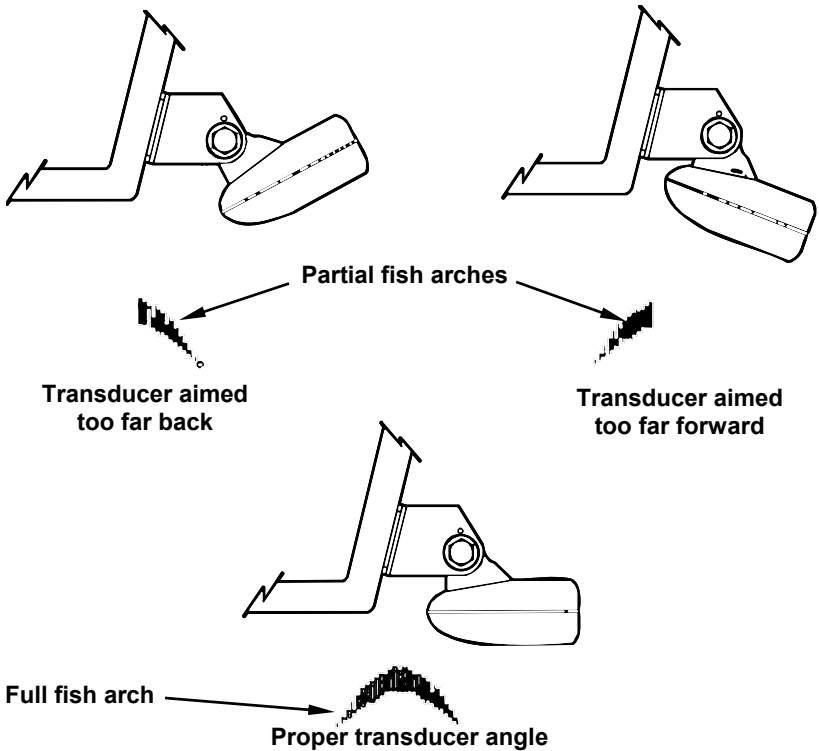

**Transducer angles and their effects on fish arches.**

If the arch slopes up – but not back down – then the front of the transducer is too high and needs to be lowered. If only the back half of the arch is printed, then the nose of the transducer is angled too far down and needs to be raised.

**NOTE:**

Periodically wash the transducer's face with soap and water to remove any oil film. Oil and dirt on the face will reduce the sensitivity or may even prevent operation.

**Shoot-Thru-Hull Preparation**

**Hulls With Flotation Materials**

The transducer installation inside a fiberglass hull must be in an area that does not have air bubbles in the resin or separated fiberglass layers. The sonar signal must pass through solid fiberglass. A successful transducer installation can be made on hulls with flotation materials (such as plywood, balsa wood or foam) between layers of fiberglass if the material is removed from the chosen area. See the following figure.

**WARNING:**

Do not remove any material from your inner hull unless you know the hull's composition. Careless grinding or cutting on your hull can result in damage that could sink your boat. Contact your boat dealer or manufacturer to confirm your hull specifications.

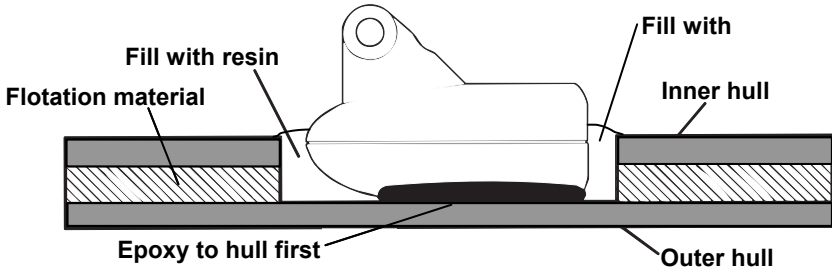

**Epoxy the transducer to a solid portion of the hull.**

For example, some (but not all) manufacturers use a layer of fiberglass, then a core of balsa wood, finishing with an outer layer of fiberglass. Removing the inner layer of fiberglass and the balsa wood core exposes the outer layer of fiberglass. The transducer can then be epoxied directly to the outer layer of fiberglass. After the epoxy cures for 24 hours, fill the remaining space with polyester resin. When the job is finished, the hull is watertight and structurally sound. Remember, the sonar signal must pass through *solid* fiberglass. Any air bubbles in the fiberglass or the epoxy will reduce or eliminate the sonar signals.

**Testing Determines Best Location**

Ideally, the shoot-thru transducer should be installed as close to the transom as possible, close to the centerline. This will give you the best performance during high speed maneuvers.

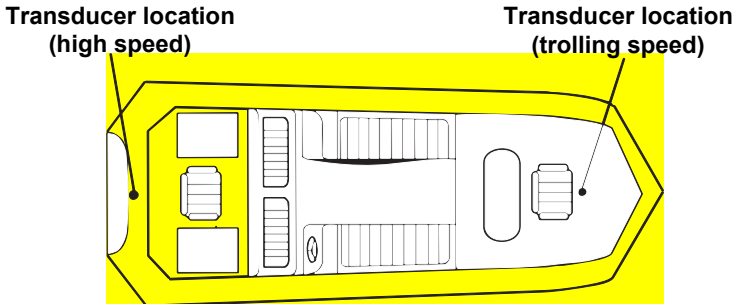

**Shoot-thru-hull transducer locations for high speed or trolling speed operation.**

To choose the proper location for shoot-thru-hull mounting, follow these testing procedures: (You may need a helper to complete these steps.)

1. Anchor the boat in about 30 feet of water. Add a little water to the sump of the boat. Plug the transducer into the sonar unit, turn it on, then hold the transducer over the side of the boat in the water. Adjust the sensitivity and range controls until a second bottom echo is seen on the display. (You'll need to turn off Auto Sensitivity, Auto Depth Range and ASP™. Try a range setting that is two to three times the water depth. The harder (more rocky) the bottom, the easier it will be to get a second bottom signal.) Don't touch the controls once they've been set.

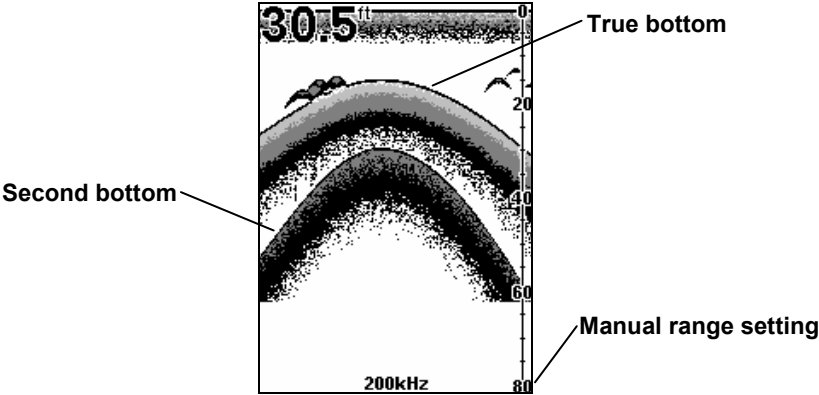

**Example of a second bottom signal. Unit is in 30 feet of water, with range set at 80 feet and sensitivity set at 87 percent.**

2. Next, take the transducer out of the water and place it in the water in the sump of the boat, face down. (The transducer face is shown in the figure on the following page.) Notice how the signal strength decreases. The second bottom signal will probably disappear and the bottom signal intensity will likely decrease.
3. Now move the transducer around to find the best location with the strongest possible bottom signal. If you find a spot with an acceptable bottom signal, mark the location and move on to step 4.

If you can't get an acceptable bottom signal, try turning up the sensitivity by three or five keystrokes and then move the transducer around once more. If you find a spot that works, mark it and move on to step 4.

If you have to turn up sensitivity by more than five keystrokes to get a good signal, the transducer should be mounted on the outside of the hull. This is especially true if you have to turn sensitivity all the way up to get a decent bottom signal.

4. Most people get good results by following steps 1 through 3, so this step is *optional*. If you want to make an extra effort to be absolutely sure

that your selected location will work under all conditions, make a test run with the boat on plane and observe the bottom signal. You'll need to figure some way to prop the transducer into position while you make your test run. (A brick or two might be sufficient to hold it in place.)

5. When you're satisfied with a location, mark it and proceed with the installation.

### Shoot-thru-hull Installation

If you are installing the transducer on a hull with floatation material sandwiched within the hull, refer to the text "Hulls With Flotation Materials" beginning on page 24.

1. Make sure the area is clean, dry and free of oil or grease, then sand both the inside surface of the hull and the face of the transducer with 100 grit sandpaper. The sanded hull area should be about 1-1/2 times the diameter of the transducer. The surface of the hull must be flat so the entire transducer face is in contact with the hull prior to bonding. After sanding, clean the hull and transducer with rubbing alcohol to remove any sanding debris.

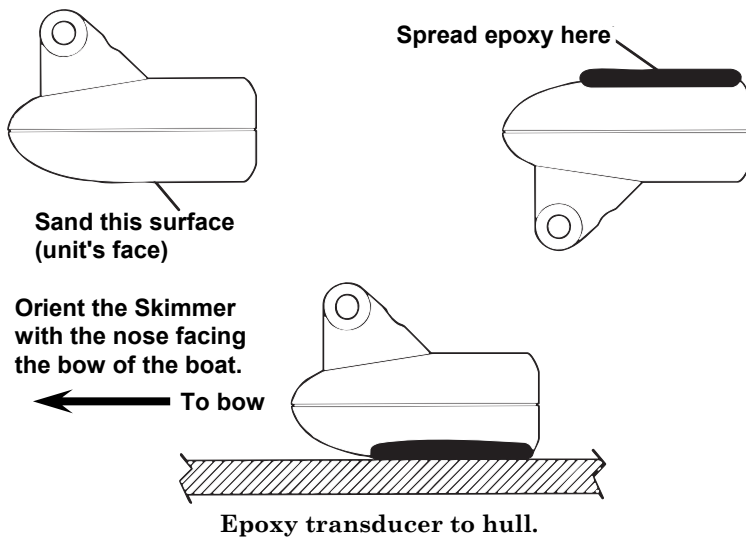

### WARNING:

Use *only* the epoxy available from LEI. It has been formulated to work with these installation procedures. Other epoxy types may be too thin or may not cure to the right consistency for optimum transducer performance.

2. The epoxy consists of the epoxy itself and a hardener. Remove the two compounds from the package and place them on the paper plate.

Thoroughly stir the two compounds together until the mixture has a uniform color and consistency. Do not mix too fast or bubbles will form in the epoxy. After mixing, you have 20 minutes to complete the installation before the epoxy becomes unworkable.

Spread a thin layer of epoxy (about 1/16" or 1.5 mm thick) on the face of the transducer as shown in the previous figure. *Make sure there are no air pockets in the epoxy layer!* Then, apply the remaining epoxy to the sanded area on the hull.

3. Press the transducer into the epoxy, twisting and turning it to force any air bubbles out from under the transducer face. Stop pressing when you bottom out on the hull. When you're finished, the face of the transducer should be parallel with the hull, with a minimum amount of epoxy between the hull and transducer.
4. Apply a weight, such as a brick, to hold the transducer in place while the epoxy cures. Be careful not to bump the transducer while the epoxy is wet. Leave the weight in place for a minimum of three hours. Allow the epoxy to cure for 24 hours before moving the boat.
5. After the epoxy has cured, route the cable to the sonar unit and it's ready to use.

## Speed/Temperature Sensors

### Optional Speed Sensor Installation

All the units in this series can display speed and distance traveled, but only the LMS-527cDF comes packed with a speed sensor. If you wish to purchase an optional additional sensor for your unit, refer to the accessory ordering information inside the back cover of this manual. The following instructions describe how to install the speed sensor.

Recommended tools for this job include: drill, 7/8" drill bit, 1/8" drill bit for pilot holes, screwdriver. Required supplies for this job include: four #8 stainless steel wood screws (3/4" long), *high quality, marine grade* above- or below-waterline sealant.

First find a location on the boat's transom where the water flow is smoothest. Don't mount the sensor behind strakes or ribs. These will disturb the water flow to the speed sensor. Make sure the sensor will remain in the water when the boat is on plane. Also make sure the location doesn't interfere with the boat's trailer. Typically, the sensor is mounted about one foot to the side of the transom's centerline.

Once you've determined the proper location for the unit, place the sensor on the transom. The bottom of the bracket should be flush with the hull's bottom. Using the sensor as a template, mark the hull for the screws' pilot holes. Drill four 1/8" holes, one in each end of the slots.

Mount the sensor to the hull using #8 stainless steel wood screws (not included). Use a *high quality, marine grade* above- or below-waterline sealant to seal the screws. Make sure the sensor is flush with the bottom of the hull and tighten the screws.

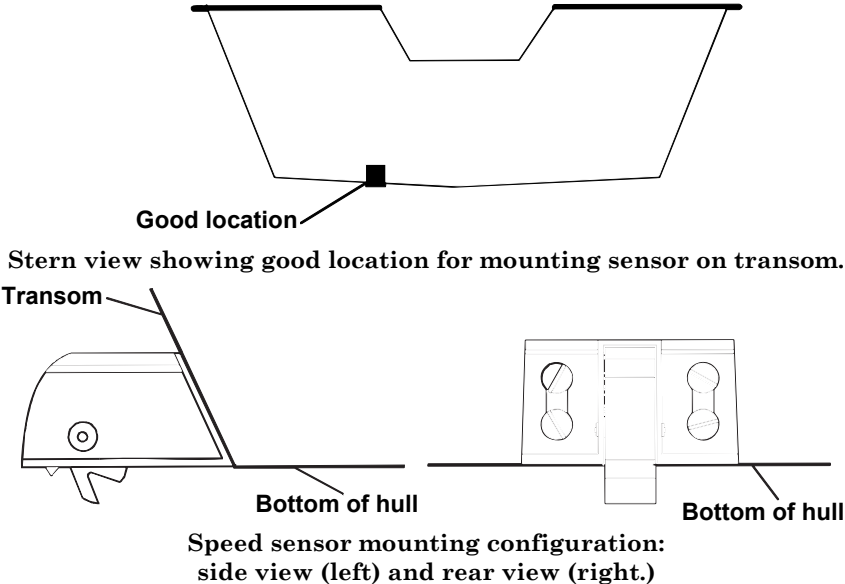

If the base of the transom has a radius, fill the gap between the transom and the sensor with the sealant. This will help ensure a smooth water flow.

Route the sensor's cable through or over the transom to the sonar unit. If you need to drill a hole in the transom to pass the connector through, the required hole size is 7/8".

**CAUTION:**

*If you drill a hole in the transom for the cable, make sure it is located above the waterline. After installation, be sure to seal the hole with the same marine grade above- or below-waterline sealant used for the screws.*

The sensor is now ready for use. Connect the sensor to the sonar socket on the back of your unit and connect the transducer to the speed sensor's socket. If you have any questions concerning the installation of the sensor, please contact your local boat dealer.

### Power Connections

Your unit comes with a power/data cable that splits into three branches, each with several exposed wires.

The thicker three-wire cable (white, red and black) is the power supply for your display unit. This cable has no label.

The thinner branch with three wires (red, black and shield) is the power cable for a NMEA 2000 network. It is labeled "NMEA 2000 POWER."

The branch with four wires (blue, yellow, orange, and shield) is a data cable, labeled "RS-232 COMM." It supports a serial communication port. This allows your unit to exchange NMEA 0183 data with another device, such as an autopilot, DSC marine radio or computer.

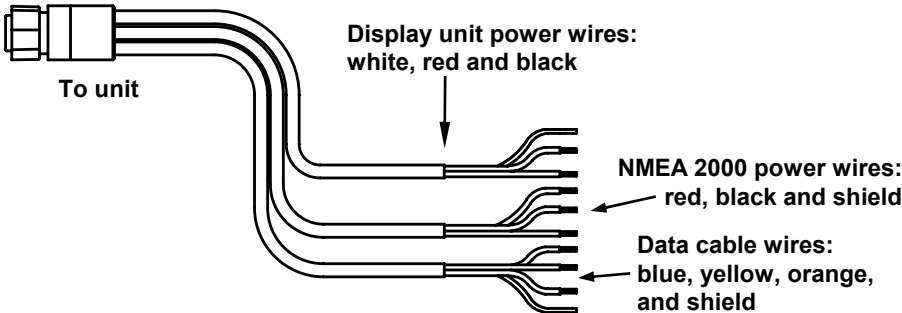

The Power/Data cable for this unit.

#### NOTE:

There are two basic power connection options, which are shown in the following two diagrams. ***Read the following instructions carefully to determine which power connection applies to your unit.*** Depending on your configuration, you may not use all of these wires.

#### Caution:

*All of the wires in the power/data cable have bare ends for easier installation. The bare ends on any unused wires could cause an electrical short if left exposed. To prevent this, you should cover the individual wire ends – either by capping them with*



*wire nuts, wrapping them with electrical tape or both. (You should cut off the bare wire before taping off the ends.)*

## **Powering Your Display Unit**

The display unit works from a 12-volt DC battery system. Attach the display power cable (with provided 3-amp fuse) to an accessory switch or power bus. If this results in electrical interference, connect direct to a battery but install an in-line switch on the cable.

### **Caution:**

*We strongly recommend that you shut off the power supply to the power cable when the unit is not in use, especially in saltwater environments. When the unit is turned off but still connected to a power supply, electrolysis can occur in the power cable plug. This may result in corrosion of the plug body along with the electrical contacts in the cable and the unit's power socket. Risk of electrolysis corrosion is even greater when the cable is unplugged from the unit, but still connected to a power source.*

*We recommend you connect the power cable to the auxiliary power switch included in most boat designs. If that results in electrical interference, or if such a switch is not available, we recommend connecting direct to the battery and installing an in-line switch. This will let you shut off power to the power cable when the unit is not in use. When you are not using the unit, you should always shut off power to the power cable, especially when the power cable is disconnected from the unit.*

### **WARNING:**

**This product *must* be independently fused with the enclosed 3-amp fuse (or equivalent), even if you connect to a fused accessory or power bus.**

***If a malfunction happens inside the unit, extensive damage can occur if the enclosed fuse is not used. As with all electrical devices, this unit could be damaged to a point it cannot be repaired and could even cause harm to the user when not properly fused.***

**Failure to use a 3-amp fuse will void your warranty.**

If possible, keep the power cable away from other boat wiring, especially the engine's wires. This will provide the best isolation from electrical noise. If the cable is not long enough, splice #18 gauge wire onto it.

The display power cable has three wires, white, red and black. Red is the positive (+) lead, black is negative (-) or ground. The white wire is unused by your unit and should be capped. Make sure to attach the in-line fuse holder to the red lead *as close to the power source as possible*.

For example, if you have to extend the power cable to the power bus or battery, attach one end of the fuse holder directly to the power bus or battery. This will protect both the unit and the power cable in the event of a short.

This unit has reverse polarity protection. No damage will occur if the power wires are reversed. However, the unit will not work until the wires are attached correctly.

### Power Diagram A

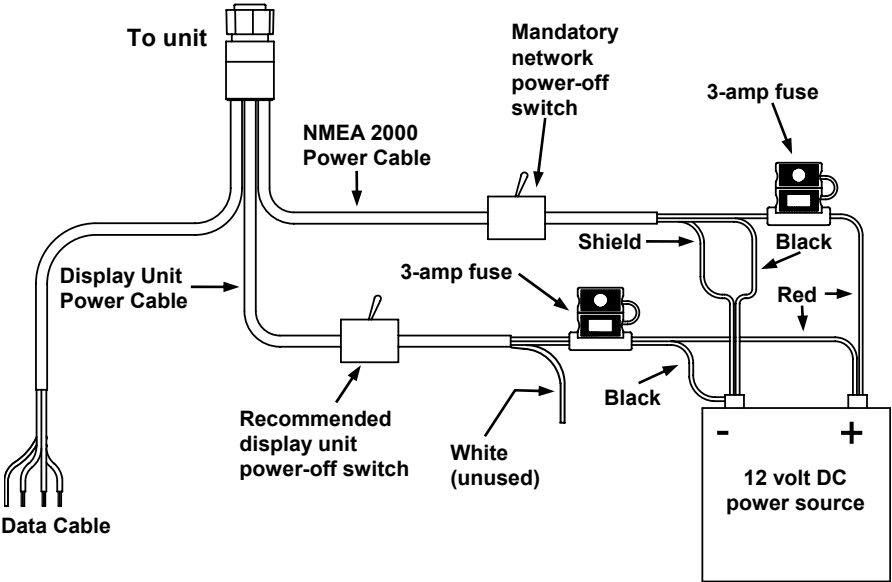

Use this method if you are powering the display unit and a GPS module or the display unit and a NMEA 2000 network. (Fuses may be different from those shown.).

*The network and any NMEA 2000 devices, including the GPS module, will not operate unless the NMEA 2000 Power Cable is connected to power. The NMEA 2000 power cable must be connected to power even if your only NMEA 2000 device is the GPS module and it is connected to the display unit's Network socket. (However, **never connect multiple power sources to a NMEA 2000 network.** If you have a network that is already powered, see diagram B on page 33.)*

## Power Diagram B

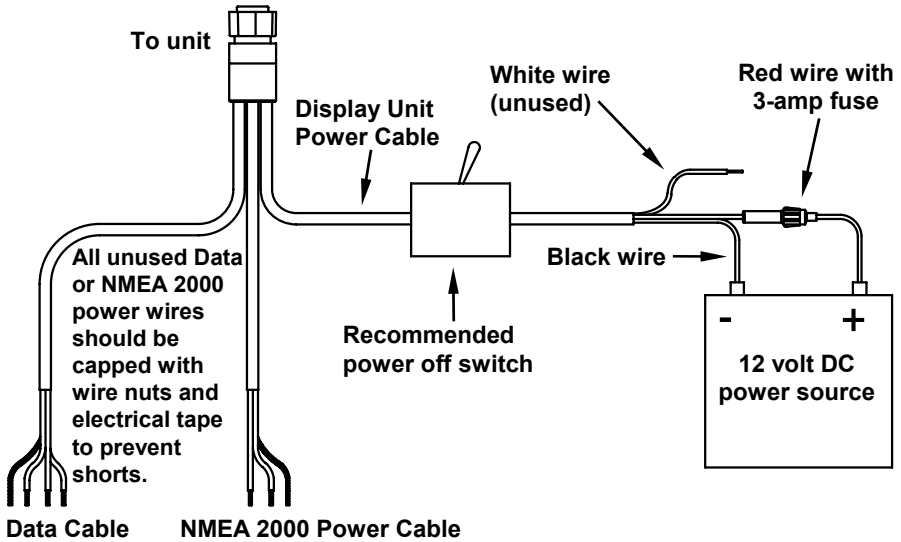

Use this method if you are *only* powering your display unit and are not powering a NMEA 2000 network or any NMEA 2000 accessory device, including a GPS module. (Fuse may be different from that shown.)

The method in diagram B is also used when your display unit is connected to a NMEA 2000 network *that is already connected to power*. (Never connect multiple power sources to a NMEA 2000 network.)

### Powering a NMEA 2000 Network Bus

A NMEA 2000 bus must be connected to a power source to operate. NMEA 2000 devices, including GPS modules, draw their power from the network bus.

If you have a pre-existing NMEA 2000 network installation, it may already be connected to another power source. If you are not sure about a network's power status, consult the boat manufacturer or dealer. *If* your NMEA 2000 bus is already powered, you can ignore the NMEA 2000 Power cable and use the method shown in Power Diagram B above. ***Never attach two power sources to a single NMEA 2000 bus.***

If you do need to power your NMEA 2000 bus, attach the NMEA 2000 Power cable to an accessory switch as indicated in power diagram A on page 32. The NMEA 2000 Power cable's red wire should be attached (with provided 3-amp fuse) to the positive (+) terminal. The NMEA 2000 Power cable's black and shield wires should both be attached to the negative (-) terminal.

**WARNING:**

The NMEA 2000 network bus is always on and constantly drawing power. You must connect NMEA power to a switched power source so you can turn off the network when not in use. Failure to connect to and use a power switch will drain your boat battery, which could stop your boat's operation.

**Connecting to a NMEA 2000 Network**

Your unit can be connected to a NMEA 2000 bus, receiving sensor information from units and devices attached to the network. Contact LEI Extras (look inside back cover for accessory ordering information) for NMEA 2000 accessories.

**NOTE:**

GPS data from your internal GPS receiver can not be transmitted across a NMEA 2000 network. The only way to transmit GPS data across the network is to add a LGC module to the network. For more information see page 203.

**NMEA 0183 Wiring  
(Data cable)**

To exchange NMEA 0183 data, this unit has one NMEA 0183 version 2.0 communication port. Com port one (Com-1) can be used to receive NMEA format GPS data. The com port can also transmit NMEA format GPS data to another device.

The four wires for the com port are combined with the Power Supply cable and NMEA 2000 Power cable to form the power/data cable (shown earlier). Com-1 uses the yellow wire to transmit, the orange wire to receive and the shield wire for signal ground. Your unit does not use the blue wire.



**Com-1 wiring to receive NMEA position information from some other GPS receiver.**

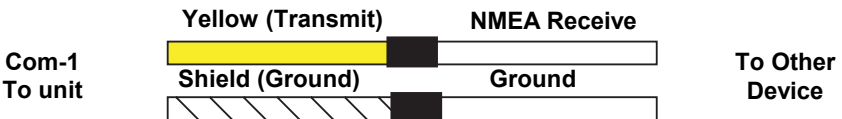

**Com-1 wiring to transmit NMEA position information to another NMEA-compatible device.**

### LMS-527cDF iGPS rear view

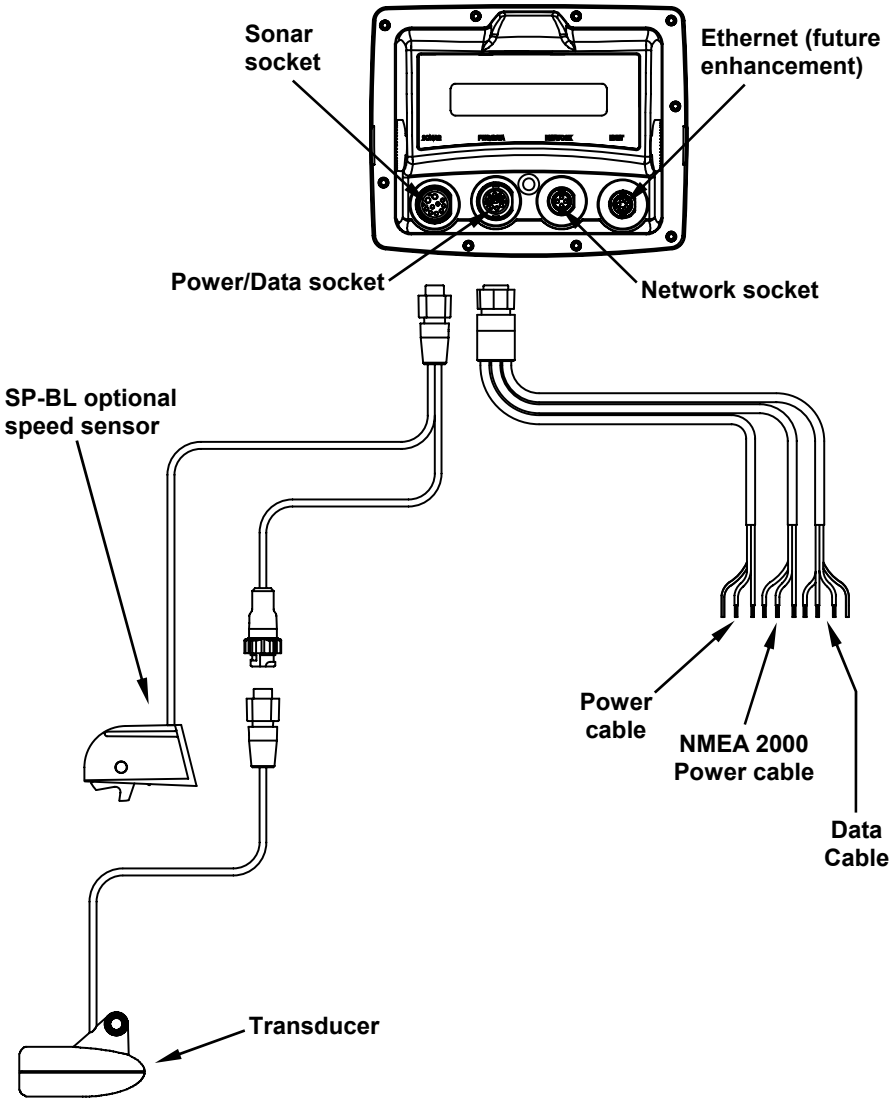

LMS-522c and LMS-527cDF cable connections.

### Mounting the Unit: Bracket or Portable

You can install your unit on the dash with the gimbal bracket or it can be used with a portable power pack. *The unit must be mounted in a location with a clear view of the sky, so the internal GPS antenna can lock-on to satellite signals.*

If you use the supplied bracket, you may be interested in the optional R-A-M<sup>®</sup> bracket mounting system. This converts the unit's gimbal bracket to a swivel mount, which can be used on the dash or overhead mounting positions.



Optional R-A-M mounting system.

**Bracket Installation**

Mount the unit in a convenient location, provided there is clearance behind the unit when it's tilted for the best viewing angle. ***This must be a location with a clear view of the sky, so the internal GPS antenna can lock-on to satellite signals.*** Make sure there is enough room behind the unit to attach the power and transducer cables.

Holes in the bracket's base allow wood screw or through-bolt mounting. You may need to place a piece of plywood on the back side of thin fiberglass panels to reinforce the panel and secure the mounting hardware.

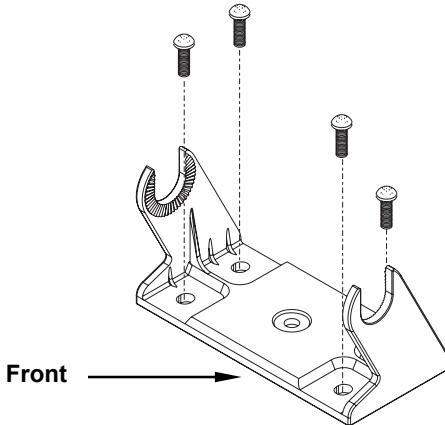

**Install the gimbal bracket. Adjust the bracket so the arms slope toward the front of your unit.**

Drill a 1-inch (25.4 mm) hole in the dash for the power, transducer and antenna cables. The best location for this hole is immediately under the gimbal bracket location. This way, the bracket can be installed so that it covers the hole, holds the cables in position and results in a neat installation. Some customers, however, prefer to mount the bracket to the side of the cable hole — it's a matter of personal preference.

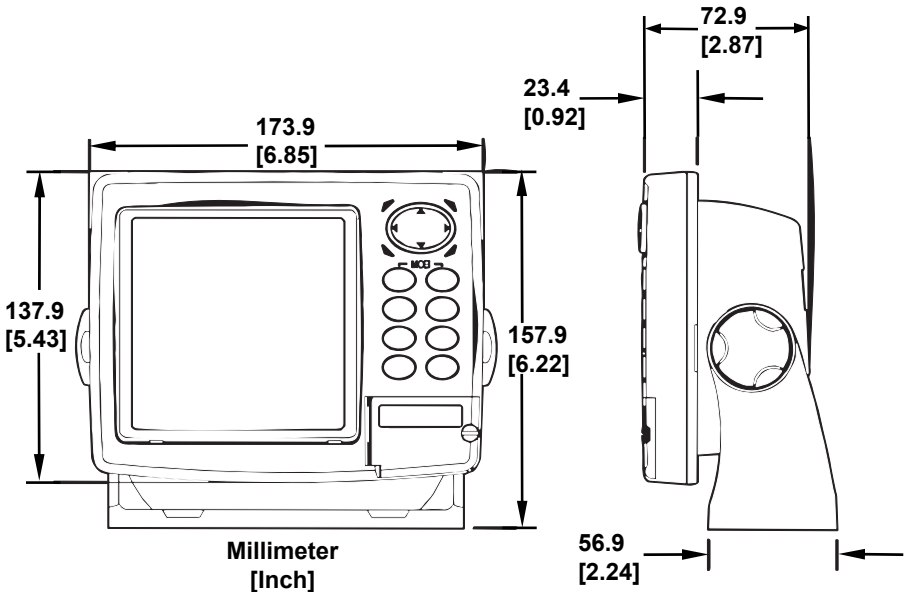

**Front view (left) and side view (right) showing dimensions of the LMS-522c and LMS-527cDF sonar/GPS units mounted on gimbal bracket.**

After drilling the hole, pass the transducer connector *up* through the hole from under the dash, followed by antenna connector. Pass the power cable's bare-wire end *down* through the hole from the top.

If you wish, you can fill in the hole around the cables with a good marine caulking compound. (Some marine dealers stock cable hole covers to conceal the opening.) No matter what type of installation you prefer, be sure to leave enough slack in the cables to allow tilting or swiveling the unit. If you choose to fill in the hole, be sure to position the cables against the rear edge of the hole as you apply the fill material.

Before positioning the bracket, *make sure the location provides a clear view of the sky, so the internal GPS antenna can lock-on to satellite signals.* Now, hold the cables against the rear edge of the hole. Slide the bracket over the hole and butt the rear of the bracket base against the cables, thus pinning them in place against the side of the hole. Fasten the bracket to the dash. Attach the unit to the gimbal bracket using the gimbal knobs and washers.

### **Portable Installation**

Like many Lowrance products, the unit is capable of portable operation by using an optional portable power pack. The power pack, a magnet-equipped antenna module and an optional portable transducer, expands the uses for your sonar/GPS unit. It makes it easy to transfer your unit from a boat to a car, recreational vehicle, airplane or other vehicle without mounting a second bracket. You can use it in your own car or boat, then take it along when riding in a friend's vehicle.

The power pack can be used with eight "D" cell alkaline batteries or an optional sealed, rechargeable battery. Visit our web site for a complete listing of all the available portable power packs.



**PPP-15 Portable Power Pack with transducer installed. Shown with the X67C IceMachine™ .**



# MMC or SD Card Memory Card Installation

Your unit uses a MultiMedia Card to store information, such as sonar logs, custom maps, waypoints, trails and other GPS data. It can also use Secure Digital Cards (SD card) to store data.

**NOTE:**

Throughout this manual, we will use the term MMC, but just remember that your unit can use an MMC *or* SD card to store data.

Both of these solid-state flash memory devices are about the size of a postage stamp. An SD card is slightly thicker than an MMC. As this manual went to press, MMCs were available in storage capacities of 8 MB, 16 MB, 32 MB, 64 MB and 128 MB. SD cards were available with capacities of 8 MB, 16 MB, 32 MB, 64 MB, 128 MB, 256 MB and 1 GB.

Additional MMC cards are available from LEI Extras; see ordering information inside the back cover of this manual. MMCs and SD cards are also available at many camera and consumer electronics stores.

The MMC slot is located in a compartment on the front of the case. The compartment door is located at the lower right corner. The following figure shows a close-up with the door opened.



**Memory card compartment with a 16 MB MMC card installed.**

### To remove an MMC

1. Open the card compartment door by unscrewing the thumb screw. The screw should only be finger tight. If it was over-tightened, use a thumbnail, a coin or a screwdriver to open the door.
2. Press a finger against the label of the MMC and drag it from the slot.
3. Close the compartment door and fasten the thumb screw finger tight.

## To insert a MMC or SD Card

1. Open the card compartment door.
2. Grasp the bottom of the MMC and push the top of the card into the slot. Once the card is started, use your fingernails to slide it the rest of the way to the left, until it is firmly seated in the slot.
3. Close the compartment door and fasten the thumb screw finger tight.

## Other Accessories

LMS-522c and LMS-527cDF accessories include MMC cards, MMC card readers and MapCreate™ 6 mapping software for your computer. MMC card readers are available in USB and parallel port versions.

Two switch boxes are available for this unit. The SB-7X transducer switch box switches two transducers to one sonar unit. The SB-8X transducer switch box switches two sonar units to one transducer.

If these accessories are not available from your dealer, see the accessory ordering information on the inside back cover of this manual. Visit our web site for a complete listing of all the available accessories.

## Cleaning Towel

A lint-free microfiber towel is included for cleaning the unit's screen. The towel is highly effective in clearing away water spots, smudges and finger prints. Just wipe the screen with the dry towel — it's not necessary to moisten the towel with water. If the screen is badly soiled, you may use water or common window or lens cleaners. **DO NOT** use polishing compounds or any other abrasive product.

If you lose the towel or wear it out, you can replace it with a similar microfiber cloth. These are often available where shop towels or automobile cleaning towels are sold.

## Caution:

*Cleaning fabrics other than the microfiber towel type may scratch the screen. Polishing compounds or other abrasive cleaners will scratch the screen. Damage caused by incorrect cleaning is not covered by the warranty. You may wash the towel if it becomes soiled or loses its effectiveness, but do not use fabric softener. Fabric softener will ruin the towel's cleaning capability.*



**MapCreate™ 6 CD-ROM (left). MMC card reader for USB ports, (right).**

Now that you have your unit installed, move on to Section 3, *Basic Sonar Operations*. There, we'll present a series of step-by-step tutorials to teach you the basics of how to operate your sonar.

**NOTE:**

When you first turn the unit on, the Map Page appears. If you'd rather start learning about GPS operation first, turn over to Section 6, *Basic GPS Operations*.

## **Face Cover**

Your unit comes with a white protective cover that snaps on and off the front of the unit. This cover is intended for use when the vehicle is idle.

**WARNING:**

**When the unit is mounted in an unprotected area, such as an open boat cockpit, the protective face cover must be removed when the vehicle is moving at high speed. This includes towing a boat on a trailer at highway speeds. Otherwise, wind blast can pop off the cover.**

# Notes

# Section 3: Basic Sonar Operation

This section addresses the unit's *most basic* sonar operations.

Before you turn on the sonar unit, it's a good idea to learn about the different keys, the Main Menu, the four Page screens and how they all work together. BUT, if you just can't wait to get on the water, turn to the one-page **Quick Reference** on page 51.

## Keyboard



LMS-527cDF sonar/GPS unit, front view, showing map with sonar split screen, keyboard and access door for the MMC slot.

1. **PWR/LIGHT** (Power & Light) – The PWR key turns the unit on and off and activates the backlight.
2. **PAGES** – Pressing this and the ← → arrow keys switches the unit between the four different page screens. (Satellite Status Page, Navigation Page, Map Page and Sonar Page.) Each page represents one of the unit's major operation modes.

3. **MENU** – Press this key to show the menus and submenus, which allow you to select a command or adjust a feature. This also accesses search functions for streets, intersections, addresses and highway exits.

4. **ARROW KEYS** – These keys are used to navigate through the menus, make menu selections, move the map and sonar chart cursors and enter data.

5. **ENT/ICONS** (Enter & Icons) – This key allows you to save data, accept values or execute menu commands. It is also used to create event marker icons.

6. **EXIT** – The Exit key lets you return to the previous screen, clear data or close a menu.

7. **WPT** – (Waypoint) The Waypoint key is used to save and recall waypoints, search for waypoints and access the waypoint list. It also launches the Point-of-Interest (POI) search menus and is involved in some navigation functions.

8. **ZOUT** – (Zoom Out) – This key lets you zoom the screen out. On the Sonar Page, it returns you to a full sonar chart display, showing the entire water column from surface to bottom. On the Map Page, it lets you see a larger geographic area on the map. Less detail is seen as you zoom out.

9. **ZIN** – (Zoom In) – This key lets you zoom the screen in. On the Sonar Page, this key enlarges fish signals and bottom detail. On the Map Page, zooming in lets you see greater detail in a smaller geographic area on the map.

## **Power/lights on and off**

To turn on the unit, press **PWR**. As the unit powers up, the Map Page is displayed first. To switch to the Sonar Page, press **PAGES**, select **SONAR** and press **ENT**.

To turn on the backlight, press **PWR** again. The unit has three backlight levels. Repeatedly pressing **PWR** will cycle through the backlight settings and turn off the backlight.

Turn off the unit by pressing and holding the **PWR** key for 3 seconds.

## **Main Menu**

The unit has a Main Menu, which contains some function commands and some setup option commands. The instructions in this section will deal only with sonar functions, the basic commands that make the unit show sonar signals on your screen. This sonar unit will work fine right out of the box with the factory default settings.

But, if you want to learn about the various sonar options, see Sec. 4, *Sonar Options & Other Features*.

You can access the Main Menu from any of the four Page screens by pressing **MENU | MENU**. To clear the menu screen and return to the page display, press **EXIT**.

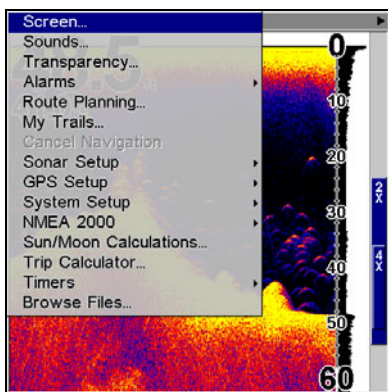

**Main Menu.**

The Main Menu commands and their functions are:

**Screen:** changes the contrast or brightness of the display screen.

**Sounds:** enables or disables the sounds for key strokes and alarms and sets the alarm style.

**Transparency:** adjusts the level of transparency for menus.

**Alarms:** turns sonar and GPS alarms on or off and changes alarm thresholds.

**Route Planning:** used to plan, view or navigate a route.

**My Trails:** shows, creates and deletes plot trails. Also used to navigate or backtrack a trail.

**Cancel Navigation:** turns off the various navigation commands. Used to stop navigating after you have reached your destination waypoint, Point of Interest or map cursor location; or after you reach the end of a route or trail.

**Sonar Setup:** sets various sonar options.

**GPS Setup:** sets various GPS receiver options.

**System Setup:** sets general configuration options.

**NMEA 2000:** provides access to all NMEA 2000 network setup options, including the configuration of devices on the network. For more information, see Section 10: NMEA 2000 Menu.

**Sun/Moon Calculations:** finds the rising and setting time of the sun and the moon.

**Trip Calculator:** shows trip status and statistics.

**Timers:** controls the up timer, down timer and alarm clock settings.

**Browse MMC Files:** this allows you to view the installed MMC card and the files it contains.

## Pages

The unit has five Page displays that represent the four major operating modes. They are the Satellite Status Page, the Navigation Page, the Map Page and Sonar Page. They are accessed by pressing the **PAGES** key, then using → or ← to select a Page. (Clear the Pages Menu by pressing **EXIT**.)

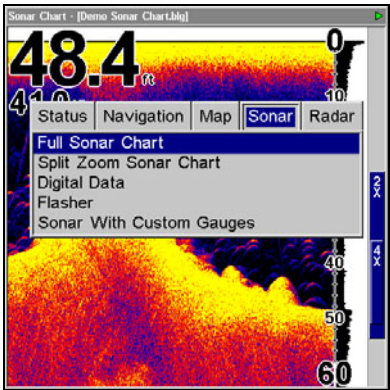

Pages Menu showing Sonar display options.

### Satellite Status Page

The Satellite Status Page provides detailed information on the status of the unit's satellite lock-on and position acquisition. To get to the Satellite Status Page: Press the **PAGES** key, then use → or ← to select **STATUS**. (Clear the Pages Menu by pressing **EXIT**).

This page represents a GPS function, so it is discussed in much greater detail in Sec. 6.

No matter what Page you are on, a flashing current position indicator/question mark symbol and flashing GPS data displays indicate that satellite lock has been lost and there is no position confirmed.

### WARNING:

**Do not begin navigating with this unit until the numbers have stopped flashing!**



|                   |          |   |  |
|-------------------|----------|---|--|
| Position Error    |          | Satellites  |  |
| 0.0 ft            |          |  |  |
| Ground Speed      |          | 2D  |  |
| 0.00 mph          |          | 3D  |  |
| Altitude          |          | WAAS  |  |
| 700 ft            |          |   |  |
| Track             |          |   |  |
| 355° mag          |          |   |  |
| Heading           |          |   |  |
| 0 mag             |          |   |  |
| Voltage           |          |   |  |
| 11.7 v            |          |   |  |
| Local Time        | UTC Time | Position - Degrees/Minutes  |  |
| 8:25:53 AM        | 13:25:53 | Latitude  |  |
|                   |          | N 36°08.971'  |  |
| Date              |          | Longitude   |  |
| November 22, 2006 |          | W 95°50.579'  |  |

Satellite Status Page.

### Navigation Page

This screen has a compass rose that not only shows your direction of travel, but also the direction to a recalled waypoint. To get to the Navigation Page: Press **PAGES** | → or ← to **NAVIGATION** | **EXIT**.

This page represents a GPS function, but also has a navigation with sonar option, which will keep you updated on what is under your boat as well as where you're going.

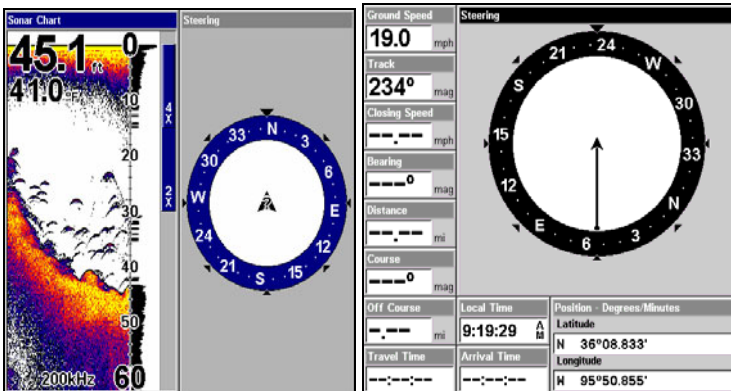

Navigation page with Sonar (left). Navigation Page with digital data (right).

### Map Page

The Map Page screens show your course and track from a "bird's-eye" view, on a moving map. By default, this unit shows the map with north always at the top of the screen. The arrow in the center of the screen is your present position. It points in the direction you're traveling.

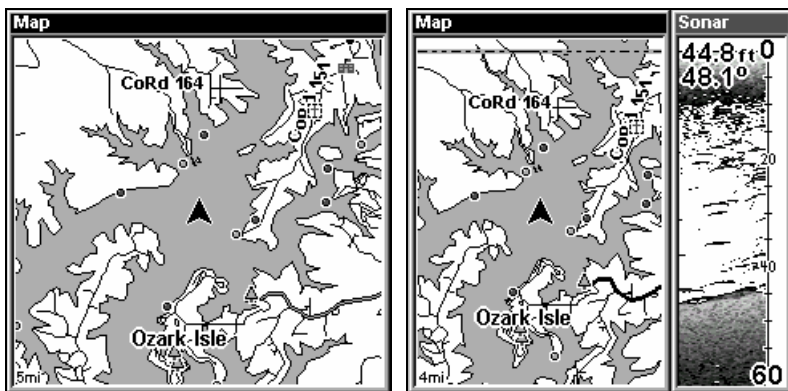

**Map Pages, showing position on Bull Shoals Lake, Arkansas. The full map option (left). Map with sonar option (right).**

Map Page is also the default screen that appears when you turn on the unit. To get to the Map Page from another page: Press **PAGES** | → or ← to **MAP** | **EXIT**.

You can display a split screen showing both the Map and Sonar pages at the same time. This feature is discussed in Sec. 4, *Sonar Options & Other Features*.

The Map Page represents a GPS function, so it is discussed in much greater detail in Sec. 6.

### **Sonar Page**

The Sonar Page displays the sonar chart. This is a "cross-section" view of the water column beneath the boat. The chart moves across the screen, displaying sonar signal echoes that represent fish, structure and the bottom.

To get to the Sonar Page: Press the **PAGES** key, then use → or ← to select **SONAR**. (Clear the Pages Menu by pressing **EXIT**.) The Pages Menu also offers five chart display options under the Sonar Page category. To access them, press **PAGES** | ← or → to **SONAR** | ↓ to *Option Name* | **EXIT**.

The Sonar Page also has its own menu, which is used for some advanced functions and for setting various options. (Sonar Options and other features are discussed in Sec. 4.) To Access the Sonar Page menu, from the Sonar Page press **MENU**.

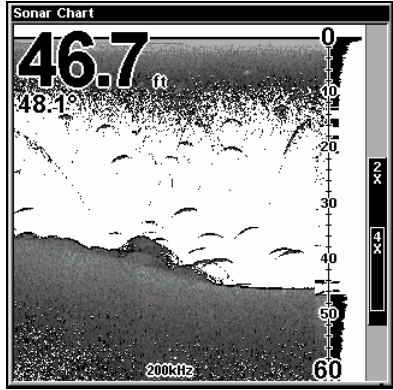
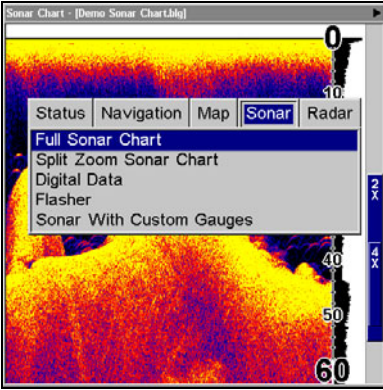

Pages Menu (left) showing sonar chart display option commands.  
 Sonar Page in full sonar chart display mode (right).

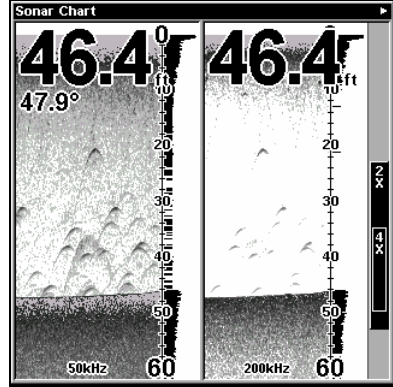
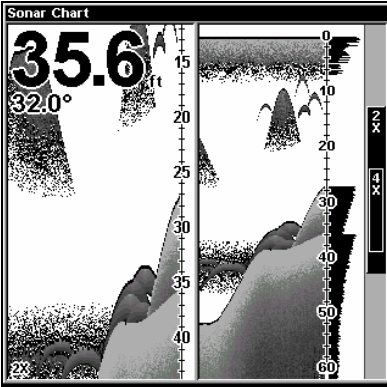

Split Zoom page (left) and Split Frequency page (right).

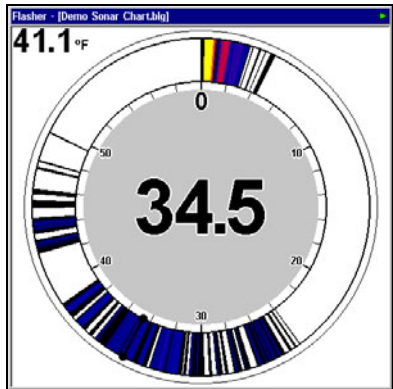
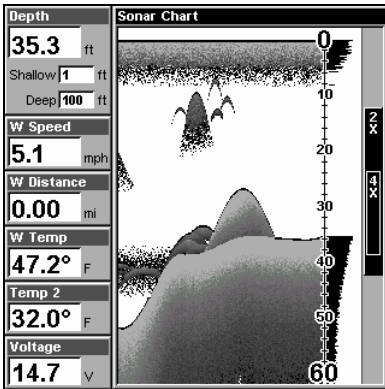

Digital Data page (left) and Flasher page (right).

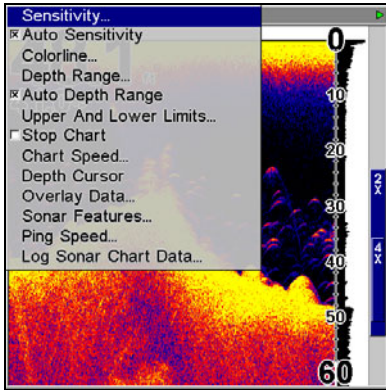

Sonar Page Menu.

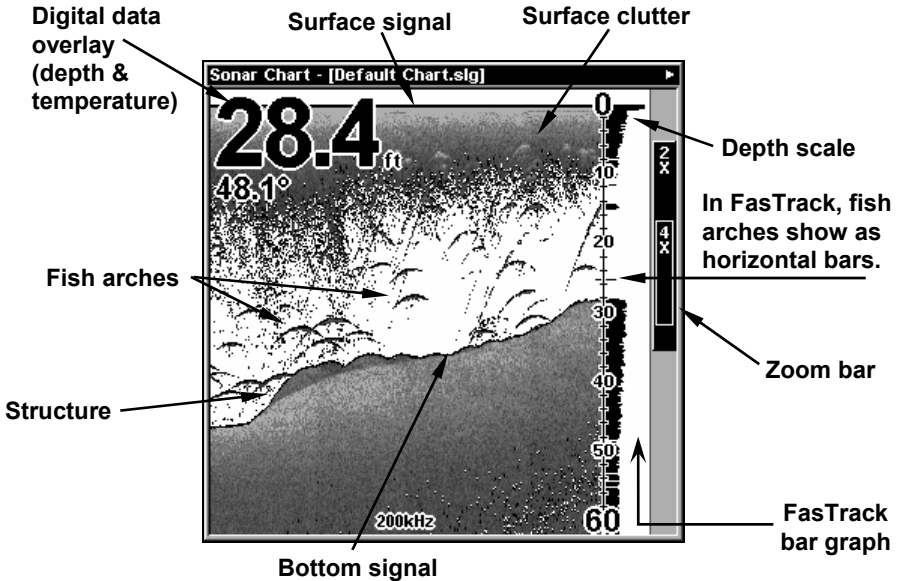

Sonar Page, showing full sonar chart mode.

You can customize how the Sonar Page displays its pictures and other data in many ways.

We'll discuss all of those features and options in Sec. 4, but to show you how easy this unit is to operate, the following page contains a simplified, 10-step quick reference that will cover most fish finding situations. The quick reference describes how your unit will operate with all the sonar features in their automatic modes, which are set at the factory.

## Basic Sonar Quick Reference

1. Depress the **PWR** key to turn on the unit.
2. Opening screen displays Map Page. Rotate through the four main Page screens (Map Page, Satellite Status Page, Navigation Page, Sonar Page) by pressing **PAGES** | ← or → to select *Page Name* | **EXIT**. Switch Pages to display Sonar Page.
3. If GPS data is desired, wait while unit locates satellites and calculates current position. When the unit acquires position, a tone sounds and a position acquired message appears.
4. With position acquired (if desired), head for your fishing grounds. Your unit will automatically display digital depth and surface water temperature in the top left corner of the screen.

The auto settings will track the bottom, displaying it in the lower portion of the screen. The full sonar chart will scroll from right to left, showing you what's under the boat as you cruise across the water. You can change the display by:

**Zoom in** to enlarge the chart for more detail: press **ZIN**.

**Zoom out** to return to full chart mode: press **ZOUT**.

5. Watch the display for the appearance of fish symbols (or arches, if Fish I.D.<sup>™</sup> is turned off). When you see fish symbols or arches, you've found fish! Stop the boat and get your lure or bait into the water at the depth indicated on the sonar chart.
6. Gauge the fish depth by visually comparing the fish symbols or arches with the depth scale on the right side of the screen.
7. If you are drifting at a very low speed or anchored, you are not moving fast enough for a fish to return the tell-tale fish arch signal. As you drift over a fish, or as a fish swims through the transducer's signal cone, the fish echo will appear as a straight line suspended between the surface and the bottom when Fish I.D. is turned off.
8. To turn off the unit, press and hold **PWR** key for three seconds.

# Sonar Operations

As you can see from the quick reference on the previous page, basic operation is pretty easy, right out of the box. If you are a sonar novice, try operating the unit with the factory defaults until you get a feel for how it's working.

As you're learning the basics, there is one setting you might want to tinker with from time to time — Sensitivity.

Sensitivity controls the unit's ability to pick up echoes. If you want to see more detail, try increasing the sensitivity, a little at a time. There are situations when too much clutter appears on the screen. Decreasing the sensitivity can reduce the clutter and show the strongest fish echoes, if fish are present. As you change the sensitivity setting, you can see the difference on the chart as it scrolls.

Fig. 1

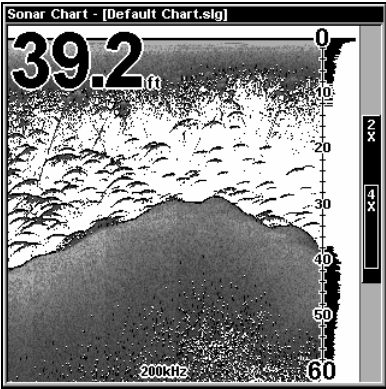

Fig. 2

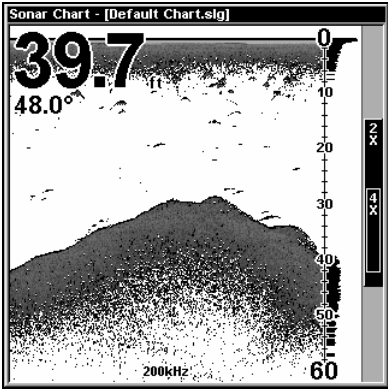

Fig. 3

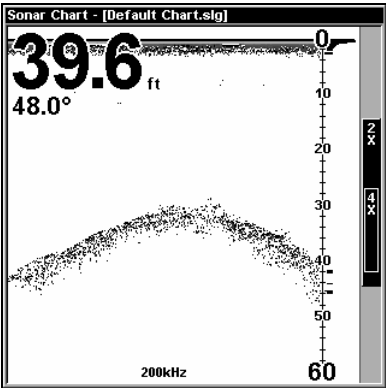
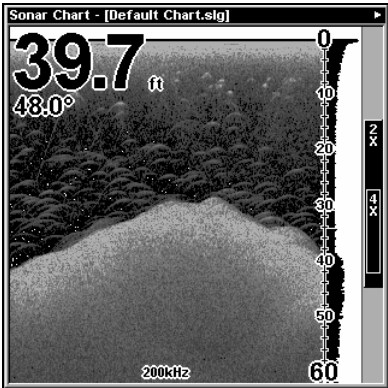

Fig. 4



These figures show results of different sensitivity levels on the same location. Fig. 1: Sensitivity at 88 percent, determined by Auto Sensitivity. Typical of full auto mode. Fig. 2: Sensitivity set at 75 percent. Fig. 3: Sensitivity set at 50 percent. Fig. 4: Sensitivity set at 100 percent.

You can change the sensitivity level whether you are in Auto Sensitivity mode or Manual Sensitivity mode. The adjustment method works the same in both modes, but it gives you slightly different results.

Adjusting sensitivity in Auto Sensitivity Mode is similar to manually adjusting a car's speed with the accelerator pedal while cruise control is on. You can tell the car to run faster, but when you let off the gas the cruise control *automatically* keeps you from running slower than the minimum speed setting. In the unit, auto mode will let you increase sensitivity to 100 percent, but the unit will *limit* your *minimum* setting. This prevents you from turning sensitivity down too low to allow automatic bottom tracking. When you change the setting with auto turned on, the unit will continue to track the bottom and make minor adjustments to the sensitivity level, with a bias toward the setting you selected.

Adjusting sensitivity in Manual Sensitivity Mode is similar to driving a car without cruise control — you have *complete* manual control of the car's speed. In the unit, manual mode allows you to set sensitivity at 100 percent (maximum) or zero percent (minimum.) Depending on water conditions, the bottom signal may completely disappear from the screen when you reduce sensitivity to about 50 percent or less!

Try adjusting sensitivity in both auto and manual modes to see how they work.

**To adjust sensitivity:**

1. Press **MENU | ENT**.
2. The Sensitivity Control Bar appears. Press ↓ to decrease sensitivity; press ↑ to increase sensitivity. When it's set at the desired level, press **EXIT**. (When you reach the maximum or minimum limit, a tone sounds.)

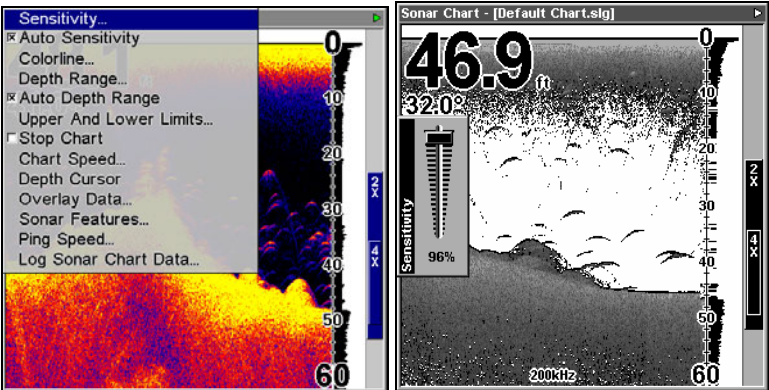

**Sonar Menu with Sensitivity command selected (left). The Sensitivity Control Bar (right).**

## NOTE:

If you want to change the sensitivity in Manual Mode, first turn off Auto Sensitivity: from the Sonar Page, press **MENU** | ↓ to **AUTO SENSITIVITY** | **ENT** | ↑ to **SENSITIVITY** | **ENT**. Press ↓ or ↑ to pick a different sensitivity setting. When it's set at the desired level, press **EXIT**.

## *Important Tip:*

While you are experimenting and learning, it's possible to scramble the settings so that the sonar picture disappears from your screen. If that happens, remember that it's easy to switch back to full automatic operation by simply restoring the factory auto settings.

## **To Restore Factory Settings:**

1. Press **MENU** | **MENU** | ↓ to **SYSTEM SETUP** | **ENT** | ↓ to **RESET OPTIONS** | **ENT**.
2. The unit asks if you want to reset all the options. Press ← to **YES** | **ENT**. All options are reset, and the unit reverts back to the Map Page at the 4000 mile zoom range. (Any recorded sonar logs or GPS data will be unchanged.)

## **Fish Symbols vs. Full Sonar Chart**

You may have noticed in the quick reference that we used fish arches in full sonar chart mode for our example, and not the popular Fish I.D.<sup>™</sup> fish symbol feature. Here's why.

Fish I.D. is an easier way for a sonar novice to recognize a fishy signal return when he sees it. However, locating fish by symbol *only* has some limitations.

Your sonar unit's microprocessor is remarkably powerful, but it can be fooled. Some of the echoes *calculated* to be fish could be tree limbs or turtles! *To see what's under your boat in maximum detail, we recommend you turn off Fish I.D. and begin learning to interpret fish arches.*

Fish I.D. is most handy when you're in another part of the boat or performing some task that prevents you from watching the sonar screen. Then, you can turn on Fish I.D. and the audible fish alarm. When that lunker swims under your boat, you'll hear it!

Fish I.D. can also be useful when you want to screen out some of the sonar detail gathered by your unit. For example, in one case fisherman in San Francisco Bay saw clouds of clutter in the water but no fish arches. When a down rigger was pulled up, it brought up several small jellyfish. The fisherman switched their sonar to Fish I.D., which screened out the schools of jellyfish and clearly showed the game fish there as fish symbols.



## Other Free Training Aids

The sonar options section discusses Fish I.D., fish alarms and other features in greater detail. If you or a friend has Internet access, you can also learn more about interpreting what you see on your sonar screen. Visit our web site, [www.lowrance.com](http://www.lowrance.com). Be sure to check out the free Sonar Tutorial, which includes animated illustrations and more pictures of actual sonar returns, all described in detail. There's even a "printer friendly" version of the tutorial available on our web site...it makes a great supplement to this operation manual!

You can also download a free copy of our Sonar Viewer software. This PC-based software application plays back any sonar chart log recorded with a Lowrance sonar product. Features include:

- Adjustable range, zoom, sensitivity, color line, noise rejection, surface clarity, etc. of the recorded file.
- Color interpretation of sonar signals can be user defined.
- Operates like a Windows Multimedia Player with forward, reverse, pause, fast forward, fast reverse, and scroll buttons.
- Adjustments update the entire record displayed.
- Can print in full color.
- Window can dynamically be sized on your monitor.
- Mouse cursor shows GPS position, depth and sounding number anywhere on the visible record.

For the ultimate training aid, be sure to download the free emulator software for your unit. Aside from being fun, this program can help you learn both basic and advanced operations without burning boat fuel! Lowrance is one of the first sonar manufacturers to provide this type of training tool for customers.

This PC application simulates the actual sonar/GPS unit on your computer. You can run it from your computer keyboard or use your mouse to press the virtual keys. Easy download and installation instructions are available on our web site.



**Free training emulator is available for your unit on our web site.**

The emulator works exactly like your real sonar/GPS unit. Using the Sonar Simulator and GPS Simulator features, it allows you to play back sonar logs, run GPS routes and trails and create real waypoints you can use in the field! You can even take snapshots of the Sonar Chart and print them or e-mail them to friends.

# Section 4: Sonar Options

## ASP™ (Advanced Signal Processing)

The ASP™ feature is a noise rejection system built into the sonar unit that constantly evaluates the effects of boat speed, water conditions and interference. This automatic feature gives you the best display possible under most conditions.

The ASP feature is an effective tool in combating noise. In sonar terms, noise is any undesired signal. It is caused by electrical and mechanical sources such as bilge pumps, engine ignition systems and wiring, air bubbles passing over the face of the transducer, even vibration from the engine. In all cases, noise can produce unwanted marks on the display.

The ASP feature has four settings — Off, Low, Medium and High. If you have high noise levels, try using the "High" ASP setting. However, if you are having trouble with noise, we suggest that you take steps to find the interference source and fix it, rather than continually using the unit with the high ASP setting.

There are times when you may want to turn the ASP feature off. This allows you to view all incoming echoes before they are processed by the ASP feature.

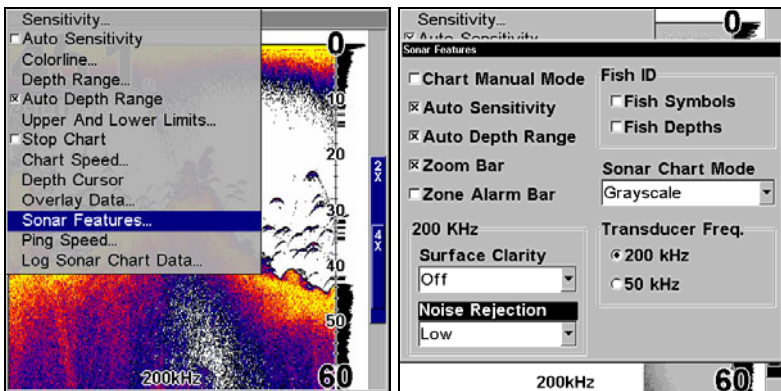

Sonar Menu with Sonar Features highlighted (left). Sonar Features menu (right) with Noise Rejection (ASP) set to default low setting.

To change the ASP level:

1. From the Sonar Page, press **MENU** | **↓** to **SONAR FEATURES** | **ENT**.
2. Press **↓** to **NOISE REJECTION** | **ENT**.

3. Press **↓** or **↑** to select a setting, then press **ENT**.
4. To return to the previous page, press **EXIT | EXIT**.

## Alarms

This unit has three different types of sonar alarms. The first is the Fish Alarm. It sounds when the Fish I.D.<sup>™</sup> feature determines that an echo is a fish.

Another alarm is the Zone Alarm, which consists of a bar on the side of the screen. Any echo on the chart that appears inside this bar triggers this alarm.

The last alarm is the Depth Alarm, which has both a Shallow and a Deep setting. Only the bottom signal will trigger this alarm. This is useful as an anchor watch, a shallow water alert or for navigation.

## Depth Alarms

The depth alarms sound a tone when the bottom signal goes shallower than the shallow alarm's setting or deeper than the deep alarm's setting. For example, if you set the shallow alarm to 10 feet, the alarm will sound a tone if the bottom signal is less than 10 feet. It will continue to sound until the bottom goes deeper than 10 feet.

The deep alarm works just the opposite. It sounds a warning tone if the bottom depth goes deeper than the alarm's setting. Both depth alarms work only off the digital bottom depth signals. No other targets will trip these alarms. These alarms can be used at the same time or individually.

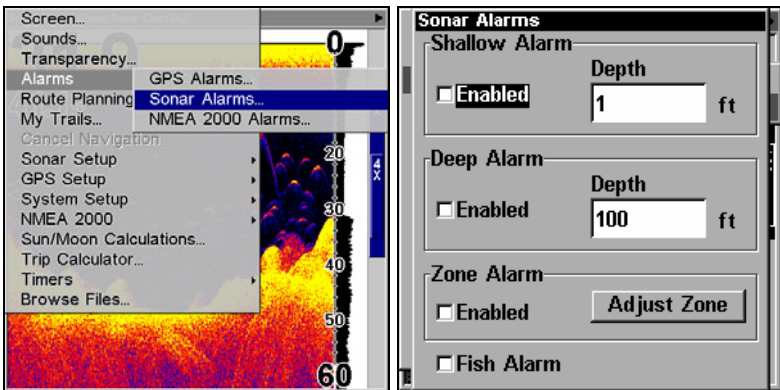

**Main Menu with GPS Alarms selected (left). Sonar Alarms menu (right).**

### To adjust and turn on the shallow alarm:

1. Press **MENU | MENU | ↓** to **ALARMS | ENT | ↓** to **SONAR ALARMS | ENT**.
2. Press **→** to **SHALLOW ALARM DEPTH | ENT**.
3. Press **↑** or **↓** to change the first number, then press **→** to move the cursor to the next number and repeat until the depth is correct, then press **ENT**.
4. Press **←** to **SHALLOW ALARM ENABLED | ENT | EXIT | EXIT | EXIT**.
5. To turn off the alarm, press **MENU | MENU | ↓** to **ALARMS | ENT | ↓** to **SONAR ALARMS | ENT | ENT | EXIT | EXIT | EXIT**.

To switch to a different depth setting, open the Sonar Alarms menu and repeat the instructions in step 3 above.

### To adjust and turn on the deep alarm:

1. Press **MENU | MENU | ↓** to **ALARMS | ENT | ↓** to **SONAR ALARMS | ENT**.
2. Press **↓** to **DEEP ALARM ENABLED | →** to **DEEP ALARM DEPTH | ENT**.
3. Press **↑** or **↓** to change the first number, then press **→** to move the cursor to the next number and repeat until the depth is correct, then press **ENT**.
4. Press **←** to **DEEP ALARM ENABLED | ENT | EXIT | EXIT | EXIT**.
5. To turn off the alarm, press **MENU | MENU | ↓** to **ALARMS | ENT | ↓** to **SONAR ALARMS | ENT | ↓** to **DEEP ALARM ENABLED | ENT | EXIT | EXIT | EXIT**.

To switch to a different depth setting, open the Sonar Alarms menu and repeat the instructions in step 3 above.

## Zone Alarm

The zone alarm is triggered when any echo passes inside the zone alarm bar, shown on the right side of the screen.

### To adjust and turn on the zone alarm:

1. Press **MENU | MENU | ↓** to **ALARMS | ENT | ↓** to **SONAR ALARMS | ENT**.
2. Press **↓** to **ZONE ALARM ENABLED | →** to **ADJUST ZONE | ENT**.

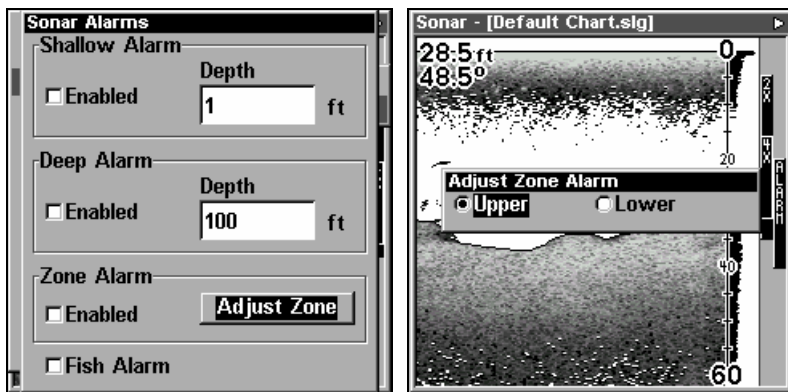

Sonar Alarms menu with Adjust Zone command selected (left).  
Adjust Zone Alarm selection box with Upper selected (right).

3. To set the upper boundary for the Zone Alarm, use ← or → to select **UPPER**, then press ↑ or ↓ to move the top of the bar to the desired depth.
4. To set the lower boundary for the Zone Alarm, use ← or → to select **LOWER**, then press ↑ or ↓ to move the bottom of the bar to the desired depth.
5. Press **EXIT | ←** to **ZONE ALARM ENABLED | ENT | EXIT | EXIT | EXIT**. Now, any echo — fish, bottom, structure — within the zone alarm's depth range will trigger the zone alarm.
6. To turn off the alarm, press **MENU | MENU | ↓** to **ALARMS | ENT | ↓** to **SONAR ALARMS | ENT | ↓** to **ZONE ALARM ENABLED | ENT | EXIT | EXIT | EXIT**.

To switch to a different depth setting, open the Sonar Alarms menu and repeat the instructions in steps 3 and 4 above.

## Fish Alarm

Use the fish alarm for a distinctive audible alarm when fish or other suspended objects are detected by the Fish I.D.<sup>™</sup> feature (Fish I.D. must be turned on for the Fish Alarm to work). A different tone sounds for each fish symbol size shown on the display.

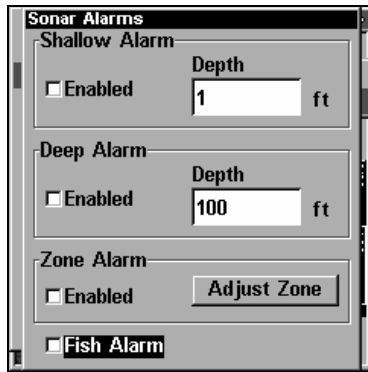

Sonar Alarms menu with Fish Alarm selected. The check box to the left is blank, indicating the alarm is turned off.

To turn on fish alarm:

1. Press **MENU | MENU | ↓** to **ALARMS | ENT | ↓** to **SONAR ALARMS | ENT**.
2. Press **↓** to **FISH ALARM | ENT | EXIT | EXIT | EXIT**.
3. To turn off the alarm, press **MENU | MENU | ↓** to **ALARMS | ENT | ↓** to **SONAR ALARMS | ENT | ↓** to **FISH ALARM | ENT | EXIT | EXIT | EXIT**.

## GPS Alarms

You can set an arrival alarm to flash a warning message and sound a tone when you cross a preset distance from a waypoint. For example, if you have the arrival alarm set to .1 mile, then the alarm will flash a message when you come within .1 mile of the recalled waypoint.

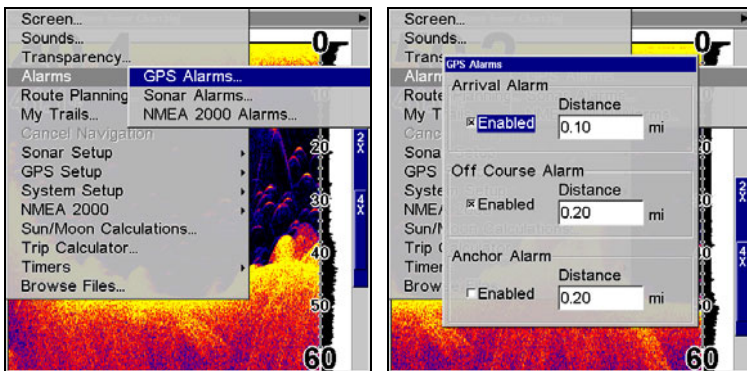

GPS Alarm highlighted on Alarms menu (left). GPS Alarms menu (right).

The off course alarm warns you when your track drifts too far to the right or left of the course line to the waypoint. For example, if the alarm is set to .1 mile, then the alarm flashes a message if you drift .1 miles to the right or left of the line to the waypoint.

The anchor alarm is triggered when you drift outside of a preset radius. Using the .1 mile as an example, if you're anchored and the boat moves more than .1 miles, a tone will sound and a message will appear.

1. To set an alarm, press **MENU | MENU | ↓** to **ALARMS | ENT | ENT**.
2. Use **↓ ↑** to select the desired category, then press **ENT** to turn on (check) or turn off (uncheck) the desired Alarm Enabled box.
3. To change distance settings, use **↓ ↑** to select the desired category, then press **→ | ENT** to activate the distance dialog box. Press **↑ ↓** to change the first character, then press **→** to the next character and repeat until the distance is set.
4. When the adjustments are finished, return to the main page display by repeatedly pressing **EXIT**.

### **IMPORTANT ALARM NOTES**

Anchor Alarm - The anchor alarm may be triggered even when you're sitting still. This can happen when using a small (less than .05 mile) anchor alarm range.

Arrival Alarm - If you set the arrival alarm's distance to a small number and you run a route (see the Navigate Routes segment), this unit may not show navigation data to the next waypoint, once you arrive at the first one. You may not be able to come close enough to the first waypoint to trip the arrival alarm.

### **NMEA 2000 Alarms**

The NMEA 2000 Alarm can be set to monitor multiple EP-10 Fuel Flow and EP-15 Fluid Level sensors. You can set a threshold for each alarm in its corresponding Percent box. Thresholds give you control over when the alarm will go off. You may want the alarm to go off when the black water tank is filled to 75 percent of its capacity, likewise, you may want to know when the fuel level falls below 30 percent of tank capacity.

To get to the NMEA 2000 Alarms menu, press **MENU | MENU**, select **ALARMS** and press **ENT**. Choose **NMEA 2000 ALARMS** and press **ENT**.

1. With the Fluid Level Device window highlighted, press **ENT** and use **↑ ↓** to select the device you want to monitor, then press **ENT**.
2. To enable the Full Alarm, highlight **FULL ALARM** Enabled box and press **ENT** to turn on (check) the alarm. Press **→** to the Percent box and press **ENT**. Use the **↑ ↓** keys to select the first number, then press **→** to move to the next number. When the desired percentage has been entered, press **ENT**.





NMEA 2000 Alarms highlighted on Alarms menu (left). NMEA 2000 Alarms menu (center). Alarm Status page (right).

3. To enable the Empty Alarm, highlight the **EMPTY ALARM** Enabled box and press **ENT** to turn on (check) the alarm. Press **→** to the Percent box and press **ENT**. Use the **↑ ↓** keys to select the first number, then press **→** to move to the next number. When the desired percentage has been entered, press **ENT**.

### Tip

You do not have to set both the Full and Empty alarms. Choose both Full and Empty alarms or activate them individually.

## Calibrate Speed

The speed sensor can be calibrated to compensate for inaccuracies. Before you change the setting, first calculate the percentage that the speed is off. You will enter this percentage in a moment.

If, for example, you figure the sensor is reading 10 percent faster than actual speed, you will enter  $-10$  in the calibration window. If the sensor is reading 5 percent slower than true speed, you will enter  $+5$  in the window.

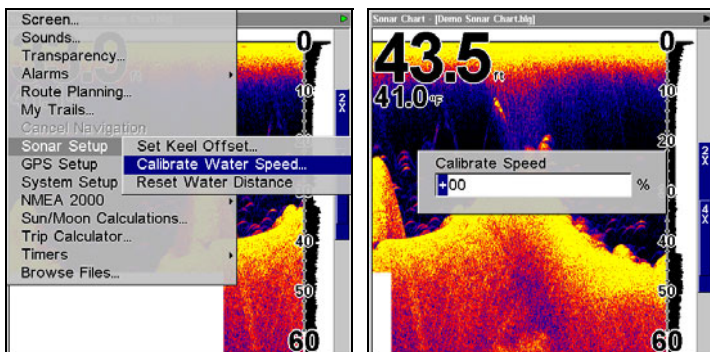

Calibrate Water Speed highlighted on Sonar Setup menu (left). Calibrate Speed dialog box (right).

A good way to gauge your speed sensor's performance is to compare its reading with the ground speed measured by your unit's GPS functions. When you make a run to compare GPS ground speed to speed sensor speed, perform your test in relatively calm water free of current, if possible. (Unless, of course, you are taking the speed of current into consideration when making your calculation.) After you have a correction figure, here's how to enter it:

1. Press **MENU|MENU|↓** to **SONAR SETUP|ENT|↓** to **CALIBRATE WATER SPEED|ENT**.
2. Enter the number you calculated earlier: press **↑** or **↓** to change the first character (+ or -), then press **→** to move the cursor to the next number and repeat until the percentage is correct, then press **EXIT**.

### Chart Speed

The rate that echoes scroll across the screen is called the chart speed. The default is maximum; we recommend that you leave the speed set there for virtually all fishing conditions.

You, however, might consider experimenting with chart speed when you are stationary or drifting very slowly. You may sometimes achieve better images as you slow down the chart speed to match how fast you are moving across the bottom.

If you are at anchor, ice fishing or fishing from a dock, experiment with a chart speed around 50 percent. If you are drifting slowly, try a chart speed around 75 percent. When you are stationary and a fish swims through the sonar signal cone, the image appears on the screen as a long line instead of a fish arch. Reducing the chart speed may result in a shorter line that more closely resembles a regular fish return.

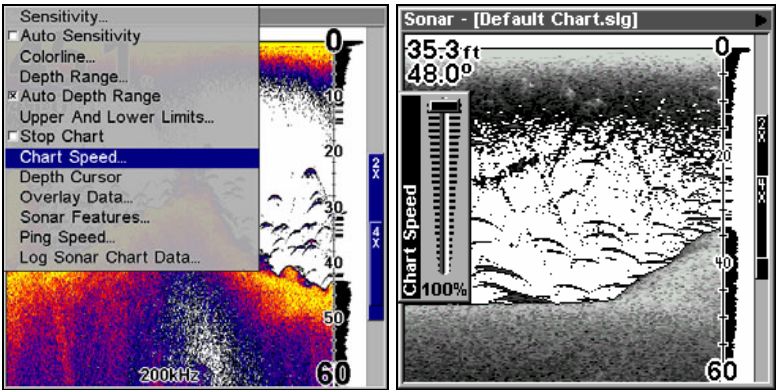

Sonar Page menu with Chart Speed command selected (left).  
Chart Speed Control Bar (right).

If you do experiment with chart speed, remember to reset it to maximum when you resume trolling or moving across the water at higher speed. To change chart speed:

1. From the Sonar Page, press **MENU** | ↓ to **CHART SPEED** | **ENT**.
2. The Chart Speed Control Bar appears. Press ↓ to decrease chart speed; press ↑ to increase chart speed.
3. When it's set at the desired level, press **EXIT**.

### Colorline™

Colorline lets you distinguish between strong and weak echoes. It "paints" a brighter color on targets that are stronger than a preset value. This allows you to tell the difference between a hard and soft bottom. For example, a soft, muddy or weedy bottom returns a weaker signal which is shown with a narrow, colored line (dark blue tinged with red or a little yellow.) Since fish are among the weakest echoes, they show up mostly as blue arches. A hard bottom or other relatively hard target returns a strong signal which causes a wider brightly colored line (reddish yellow to bright yellow.)

If you have two signals of equal size, one with red to yellow color and the other without, then the target with brighter color (yellow) is the stronger signal. This helps distinguish weeds from trees on the bottom, or fish from structure.

Colorline is adjustable. Experiment with your unit to find the Color-Line setting that's best for you.

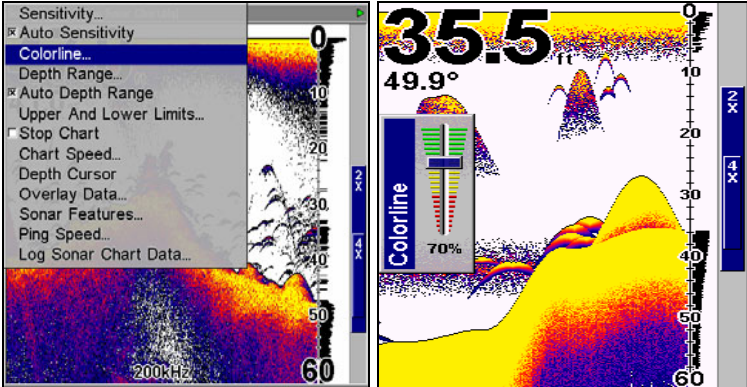

Sonar Page menu with ColorLine command selected (left).  
The Colorline control bar (right).

### To adjust Colorline level:

1. From the Sonar Page, press **MENU** | ↓ to **COLORLINE** | **ENT**.
2. The ColorLine Control Bar appears. Press ↓ to decrease ColorLine; press ↑ to increase ColorLine.
3. When it's set at the desired level, press **EXIT**.

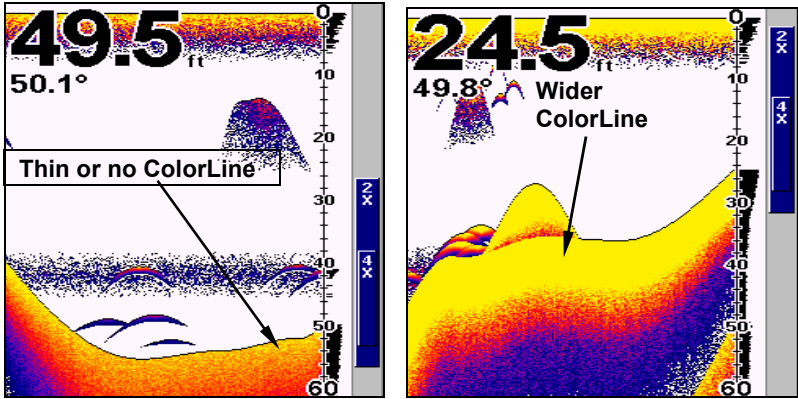

A small amount of Colorline (left) is indicative of a soft bottom. A wider patch of Colorline indicates a harder bottom (right).

### Depth Cursor

The depth cursor consists of a horizontal line with a digital depth box on the right side. The numbers inside the box show the depth of the cursor.

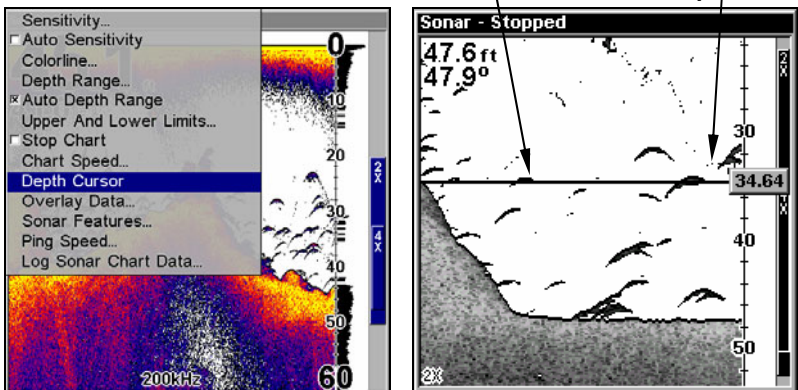

Sonar Page menu with Depth Cursor selected (left). Sonar chart with active depth cursor (right). The cursor is set at 34.64 feet deep.

The cursor can be moved to any location on the screen, letting you pinpoint the depth of a target.

1. From the Sonar Page, press **MENU** | ↓ to **DEPTH CURSOR** | **ENT**.
2. The depth cursor appears. Press ↓ to lower the cursor line; press ↑ to raise the cursor line.
3. To clear the depth cursor, press **EXIT**.

## Depth Range - Automatic

When turned on for the first time, the bottom signal is automatically placed in the lower half of the screen. This is called Auto Ranging and is part of the automatic function. However, depending upon the bottom depth and the current range, you can change the range to a different depth. To do this:

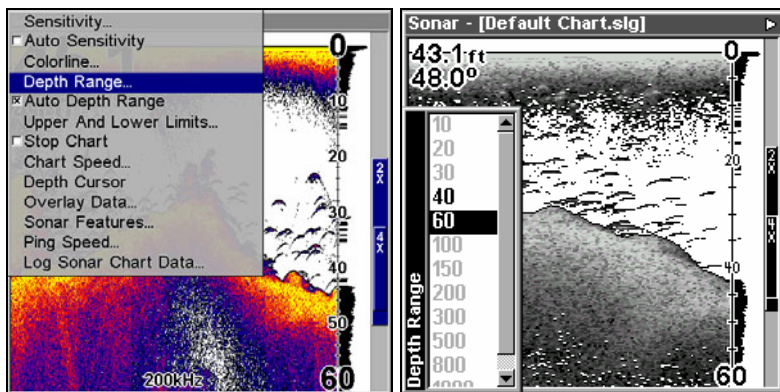

**Sonar Page menu with Depth Range selected (left). Depth Range Control Scale (right).**

1. From the Sonar Page, press **MENU** | ↓ to **DEPTH RANGE** | **ENT**.
2. The Depth Range Control Scale appears. Press ↑ or ↓ to select a different depth range. A blue bar highlights the selected range. The light numbers cannot be selected.
3. When the new range is selected, press **EXIT** to clear the menu.

## Depth Range - Manual

You have complete control over the range when the unit is in the manual mode. There are 16 depth ranges, from 5 feet to 4,000 feet.

### To switch to Manual Depth Range:

1. First, turn off automatic depth range. From the Sonar Page, press **MENU** | ↓ to **AUTO DEPTH RANGE** | **ENT**.
2. Press ↑ to **DEPTH RANGE** | **ENT** and the Depth Range Control Scale appears.



- Press  $\downarrow$  or  $\uparrow$  to select a different depth range. A horizontal blue bar highlights the selected range.
- When the new range is selected, press **EXIT** to clear the menu. Repeat these steps to turn on Auto Depth Range.

**NOTE:**

The sonar's depth capability depends on the water, bottom conditions, transducer installation and other factors.

### Depth Range - Upper and Lower Limits

Virtually any segment of the water column can be displayed by using the upper and lower limit feature. This lets you pick the shallow and deep depth range limits that are shown on the screen, provided there is at least 10 feet between the upper and lower limit you select. For example, a range from 12 feet to 34 feet could be used.

Changing the upper and lower limits gives you far greater control over the depth range. This feature lets you "zoom in" the display in almost unlimited combinations. Nearly any segment of the water column, from the surface to the bottom can be shown.

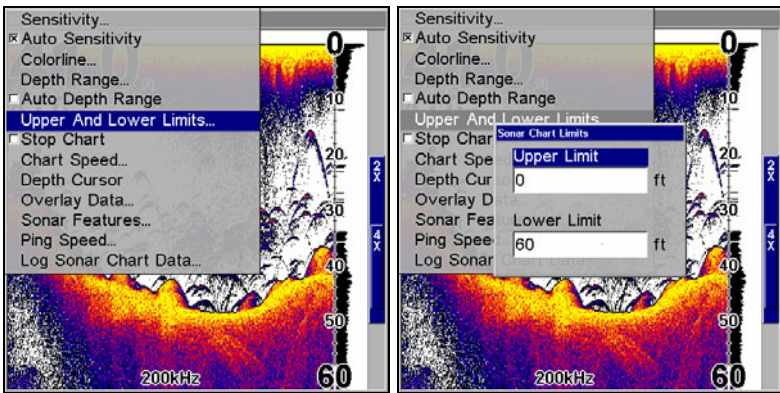

Sonar Page Menu with Upper and Lower Limits selected (left). Sonar Chart Limits menu with Upper Limit selected (right).

**To change the upper and lower limits:**

- From the Sonar Page, press **MENU** |  $\downarrow$  to **UPPER AND LOWER LIMITS** | **ENT**. The Sonar Chart Limits menu appears, with Upper Limit selected.
- To set the upper limit, press **ENT**. Press  $\uparrow$  or  $\downarrow$  to change the first number, then press  $\rightarrow$  to move the cursor to the next number and repeat until the depth is correct, then press **EXIT**.

3. To set the lower limit, press ↓ to **LOWER LIMIT** | **ENT**. Press ↑ ↓ to change the first number, then press → to move the cursor to the next number and repeat until the depth is correct, then press **EXIT** repeatedly.

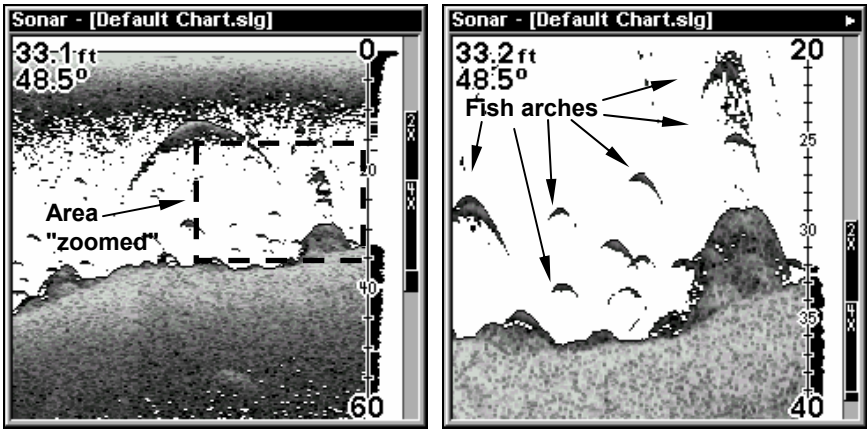

Normal display, in auto depth range mode (left). Display "zoomed" with Upper and Lower Limits focusing on the portion of the water column from 20 feet to 40 feet deep (right). In the "zoomed" image, note the target definition at lower left, showing a fish holding just above the structure.

**To turn off upper and lower limits:**

From the Sonar Page, press **MENU** | ↓ to **AUTO DEPTH RANGE** | **ENT** | **EXIT**.

**FasTrack™**

This feature automatically converts all echoes to short horizontal lines on the display's far right side. The graph on the rest of the screen continues to operate normally. FasTrack gives you a rapid update of conditions directly under the boat. This makes it useful for ice fishing, or when you are fishing at anchor. When the boat is not moving, fish signals are long, drawn out lines on a normal chart display. FasTrack converts the graph to a vertical bar graph that, with practice, makes a useful addition to fishing at a stationary location.

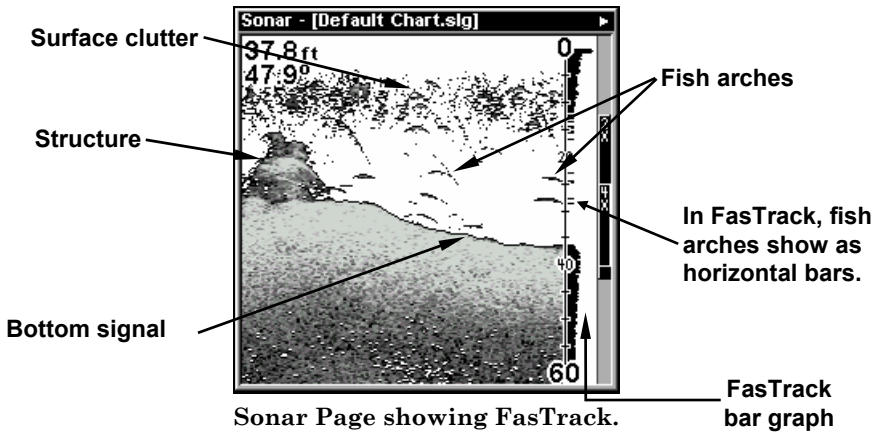

Sonar Page showing FasTrack.

## Fish I.D.<sup>™</sup> (Fish Symbols & Depths)

The Fish I.D. feature identifies targets that meet certain conditions as fish. The microcomputer analyzes all echoes and eliminates surface clutter, thermoclines, and other signals that are undesirable. In most instances, remaining targets are fish. The Fish I.D. feature displays fish symbols on the screen in place of the actual fish echoes.

There are several fish symbol sizes. These are used to designate the relative size between targets. In other words, Fish I.D. displays a small fish symbol when it thinks a target is a small fish, a medium fish symbol on a larger target and so on.

The sonar's microcomputer is sophisticated, but it can be fooled. It can't distinguish between fish and other suspended objects such as trotlines, turtles, submerged floats, air bubbles, etc. Individual tree limbs extending outwards from a group of limbs is the hardest object for the Fish I.D. feature to distinguish from fish.

You may see fish symbols on the screen when actually, there are no fish. The reverse is also true. The illustrations on the next page show how Fish I.D. can actually *miss* fish that *are* present.

Does that mean Fish I.D. is broken? No — the feature is simply interpreting sonar returns in a specific way to help take some of the work out of reading the screen. Remember: Fish I.D. is one of the many tools we provide so you can analyze your sonar returns for maximum fish finding information. This and other features can help you successfully "see" beneath the boat under varied water and fishing conditions. So, practice with the unit in both the Fish I.D. mode and without to become more familiar with the feature. The default for Fish I.D. is off.



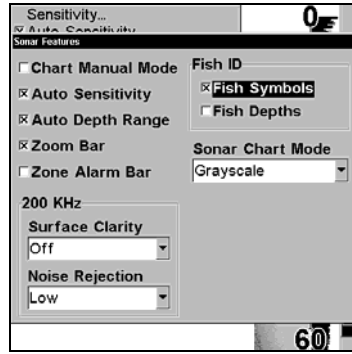
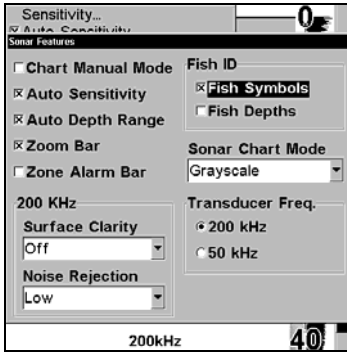

Sonar Features menu with Fish I.D. Symbols selected on dual-frequency menu (left); single-frequency menu (right). When the check box to the left is checked, the feature is on.

Fig. 1 A

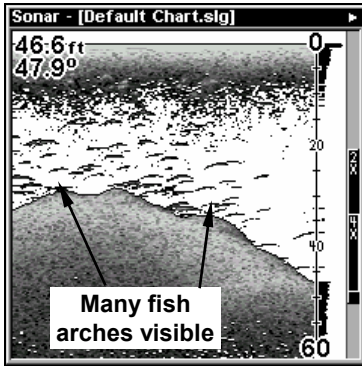

Fig. 1 B

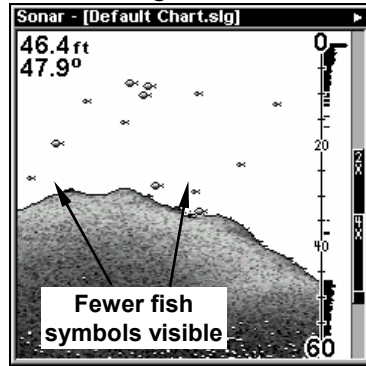

Fig. 2 A

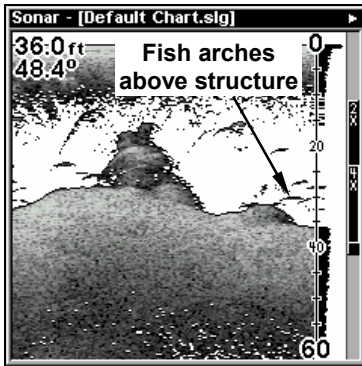
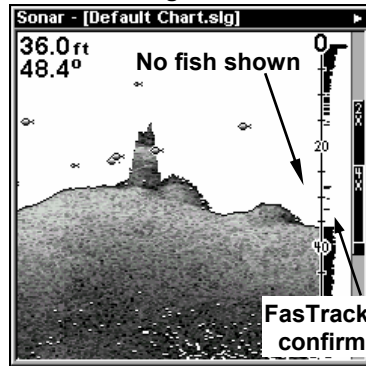

Fig. 2 B



Figures 1A and 2A show Sonar Page in normal chart mode (left). Figures 1B and 2B (right) show the same underwater scene with Fish I.D. turned on. Note how arches are replaced with symbols.

**To turn the Fish I.D. feature on:**

1. From the Sonar Page, press **MENU** | ↓ to **SONAR FEATURES** | **ENT**.
2. Press → to **FISH SYMBOLS** | **ENT** | **EXIT** | **EXIT**.

To turn off Fish I.D., repeat the instructions in step 2.

**FishTrack™**

The FishTrack feature shows the depth of a fish symbol when it appears on the display. This lets you accurately gauge the depth of targets. This feature is available only when the Fish I.D. feature is on. The default setting for FishTrack is off.

**To turn on FishTrack:**

(**Note:** These instructions will turn on FishTrack *and* Fish I.D. at the same time.)

1. From the Sonar Page, press **MENU** | ↓ to **SONAR FEATURES** | **ENT**.
2. Press → | then press ↓ to **FISH DEPTHS** | **ENT** | **EXIT** | **EXIT**.

To turn off FishTrack, repeat the instructions in step 1. Turning off FishTrack in this manner will not turn off Fish I.D. symbols.

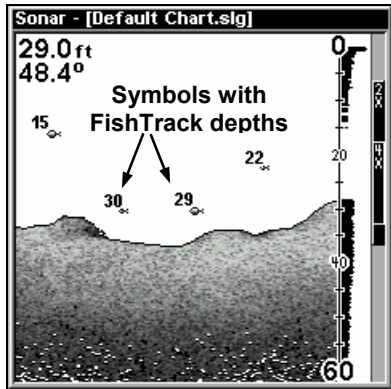
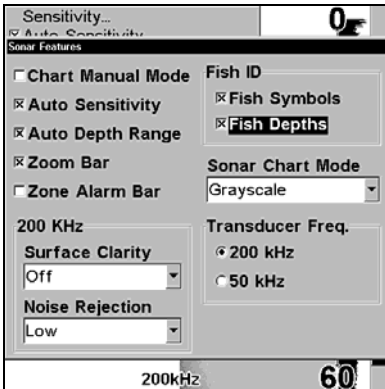

Sonar Features menu with Fish I.D. Depths selected on dual-frequency menu (left). When the check box to the left is checked, the feature is on.

Sonar Page with Fish I.D. symbols and FishTrack depths turned on (right).

**Frequency (Change Transducer Frequency)  
(LMS-527cDF only)**

The LMS-527cDF transducer can operate at both 200 kHz and 50 kHz. The 200 kHz frequency has a 12° cone angle and the 50 kHz frequency has a 35° cone angle.

The default frequency is 200 kHz, which is best for use in shallow water (about 300 feet or less). This frequency is the best choice for about 80 percent of the fresh and salt water sport fishing applications. When you get into very deep salt water, 300 to 500 feet or deeper, the 50 kHz frequency is the best choice.

The 200 kHz transducer will give you better detail and definition, but less depth penetration. The 50 kHz transducer will give you greater depth penetration, but a little less detail and less definition. (Remember, all sonar units typically read deeper in fresh water than in salt water.)

There is a common exception to these rules of thumb. Some fishermen on freshwater lakes (or the ocean) using downriggers like to see them on the sonar. In many of those cases, you'll see a 50 kHz transducer frequency in use because the wider cone angle lets them watch the bait.

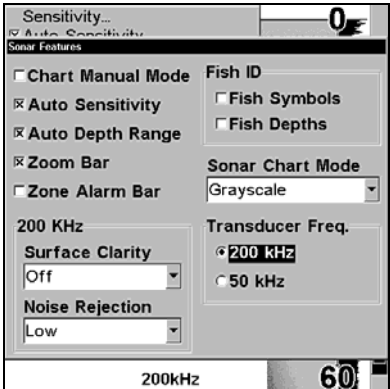

Sonar Features menu with a frequency of 200 kHz selected.

**To change the frequency setting to 50 kHz:**

1. From the Sonar Page, press **MENU** | ↓ to **SONAR FEATURES** | **ENT**.
2. Press → | then press ↓ to **50 kHz** | **ENT**.
3. Press **EXIT** | **EXIT** to clear the menu.

**To change the frequency setting to 200 kHz:**

1. From the Sonar Page, press **MENU** | ↓ to **SONAR FEATURES** | **ENT**.
2. Press → | then press ↓ to **200 kHz** | **ENT**.
3. Press **EXIT** | **EXIT** to clear the menu.

**HyperScroll™**

See the entry on Ping Speed, which controls the HyperScroll feature.

# Log Sonar Chart Data

If you have an MMC installed in the unit, the sonar data shown on the screen can be saved to the MMC. This can be played back at any time (to play a recorded sonar chart log, see the entry in this section for Sonar Simulator). If you have a personal computer and Internet access, visit our web site, [www.lowrance.com](http://www.lowrance.com), and download the free Sonar Viewer and the emulator for your unit. These programs will allow you to replay sonar logs on your personal computer.

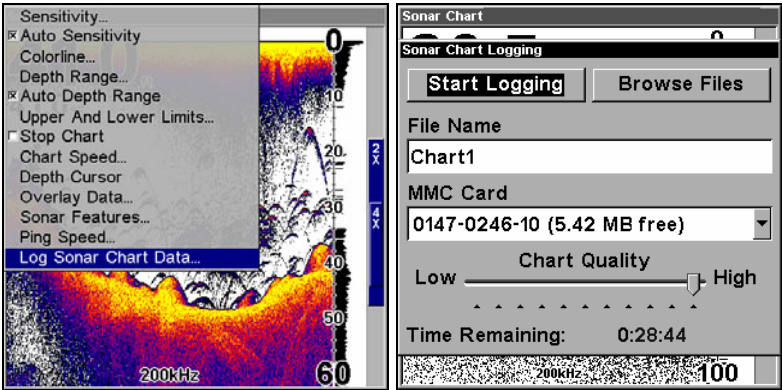

Sonar Page menu with the Log Sonar Chart Data selected (left). Sonar Chart Logging menu (right) with the Start Logging selected. The menu says the MMC has 5.42 MB of free space, which will record the scrolling chart for 28 minutes and 44 seconds.

### To record or log chart data:

1. Press **MENU** | ↓ to **LOG SONAR CHART DATA** | **ENT**.
2. To record data using the default settings, press **ENT**. The menu clears and the Sonar Page title bar shows the name of the file you are recording. Warning messages will appear as recording time begins to run out.

### NOTE:

You can change any of the settings by using the cursor arrows to highlight different commands. Select **FILE NAME** if you want to change the name. Select **CHART QUALITY** if you want to lower the file quality and record for a longer period of time. After you've changed the settings, select **START LOGGING** and press **ENT**.

## Noise Rejection

See the entry on Advanced Signal Processing in this section.

## Overlay Data

On any Page display except Satellite Status, you can "float" or overlay additional GPS or navigation data on the screen with the Overlay Data command. For example, if you left your watch at home, you could display the local time on top of the map. Or, if you wanted to see details about your route and trip, you could show your bearing, course, average speed and trip distance.

The various data available from your unit are divided into categories in the Overlay Data menu. These categories include GPS Data, Navigation, Trip Calculator, Time, Sonar Data and Miscellaneous Data.

You can select items from any of these categories for display, in any combination — the category divisions are there only to help you sort through the information.

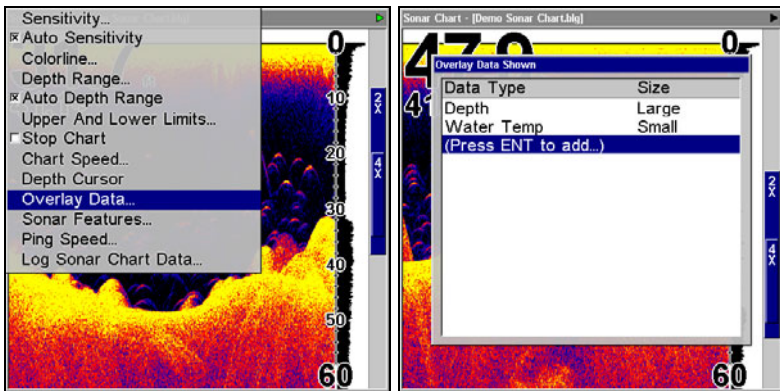

Overlay Data highlighted on sonar menu (left). Overlay Data Shown menu (right).

### To overlay information on your screen:

1. Press **MENU** | ↓ to **OVERLAY DATA** | **ENT**.
2. If you currently have any overlay data on your screen, it will be listed here. Select (**ENTER TO ADD**) and press **ENT**. The data viewer shows information categories with "+" or "-" symbols next to each category name. A category with a "+" next to it is *expandable*, meaning its contents are hidden.

Selecting the category name and pressing **ENT** will show the category's contents, so you can choose items within it. An expanded category (one with a "-" next to its name) can be collapsed to hide its contents. Just select the category name and press **ENT**.

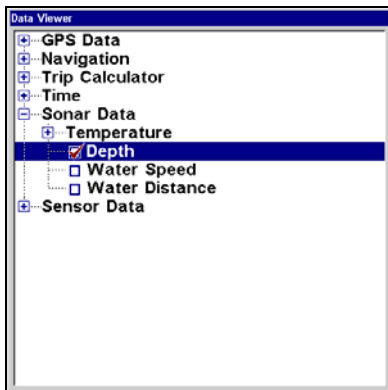
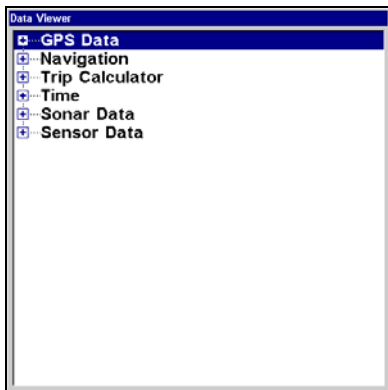

Data Viewer menu (left). Sonar Data category expanded (right).

3. Expand any categories that might contain data you want to display. Then press  $\downarrow$  or  $\uparrow$  to select a data option.
4. With the data option highlighted, press **ENT** to check it (turn on) and uncheck it (turn off). As you turn it on, the data will appear on top of the screen. Every Page display has a maximum number of items you can show using the Overlay Data command.
5. After the desired changes are made, press **EXIT|EXIT** to return to the page display.

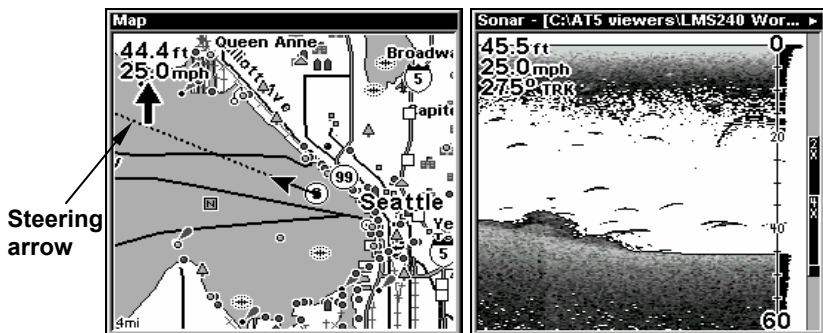

Map Page showing boat cruising Puget Sound, Washington (left) with Overlay Data turned on. This example shows Depth, Ground Speed and the Steering Arrow. Note that the Steering Arrow always points directly to the destination you are navigating toward. In this case, the boater is headed on a northwesterly course of  $275^\circ$ . Since the helmsman is on course, the Steering Arrow is pointing straight ahead. If the boat veered off course, the arrow would show which direction to steer to get back on course. Sonar Page with Overlay Data turned on (right), showing Depth, Ground Speed and the Track the boat is following.

### To remove overlaid data:

1. While on the Page that shows the item or items you want to remove, press **MENU** | ↓ to **OVERLAY DATA** | **ENT**.
2. You'll see a list of the overlay data currently displayed. Select the item you want to remove from your display and press **ENT** | **ENT** to remove the data. To remove another item, select the item and press **ENT** | **ENT**.
3. When you have finished removing all the items you want from the screen, press **EXIT** to return to the page display.

### NOTE

You can also remove data directly from the Data Viewer menu by un-checking the data option you would like to remove.



**Overlay Data Shown with Water Temp selected (left). Remove button highlighted (center). Water Temp has been removed from Overlay Data Shown menu (right).**

### To move overlaid data:

You may find it useful to rearrange data that is floating in your display window.

1. From one of the Map Pages, press **MENU** | ↓ to **OVERLAY DATA** | **ENT**.
2. You'll see a list of the overlay data currently displayed. Select the item you want to move and press **ENT** | → to **MOVE** | **ENT**.
3. The data begins to flash on your screen. Use any combination of →, ←, ↑ and ↓ to move the data to a new location on the screen.
4. When satisfied, press **EXIT** | **EXIT**.

### NOTE:

The Customize command and the Overlay Data command both use the same information categories. The difference between the two commands is that Customize changes only the data boxes on a

screen, and Overlay Data changes only the information floating on the screen without a box. See *Customize Page Displays*, on page 86, for information on customizing data boxes.

**To change displayed data font size:**

1. From the Map or Sonar page, press **MENU** | ↓ to **OVERLAY DATA** | **ENT**.
2. Press ↓ or ↑ to select *Data Type*, then use ← → to scroll through the five overlay options: Off, Small, Medium, Large and Enormous.
3. Select the desired setting. The selected data type will be displayed in the new size. To change the font size for another Data Type, repeat Steps 2 and 3. Press **EXIT** to return to the sonar display.

**NOTE:**

Some data types can be displayed in only one font size. If that is the case, the Data Size box will not be displayed for that data type.

## **Ping Speed & HyperScroll™**

Ping Speed controls the rate at which the transmitter and transducer broadcast sonar sound waves — pings — into the water. The unit has a default ping speed of 50 percent. At normal boating speeds, this automatically provides enough return echoes to refresh the screen and scroll the chart at maximum chart speed.

However, when you are running at high speeds, or just want the fastest possible screen update, you may want to use the HyperScroll™ feature. When you change the Ping Speed to any setting greater than 50 percent, the unit automatically enters HyperScroll mode.

These faster ping rates allow you to maintain a high-detail picture on the screen, and the screen refresh rate and chart scroll speed can keep pace with the boat as it moves quickly over the bottom terrain.

When using HyperScroll, you may also need to manually decrease the sensitivity for optimum performance. Depending on water depth and other conditions, HyperScroll may cause a second bottom echo to return to the transducer during the next ping cycle, or sounding. This can result in a large amount of clutter appearing on the screen. If this occurs, just decrease the sensitivity to a level that eliminates the clutter. When you turn HyperScroll off, you can return to your original sensitivity level.



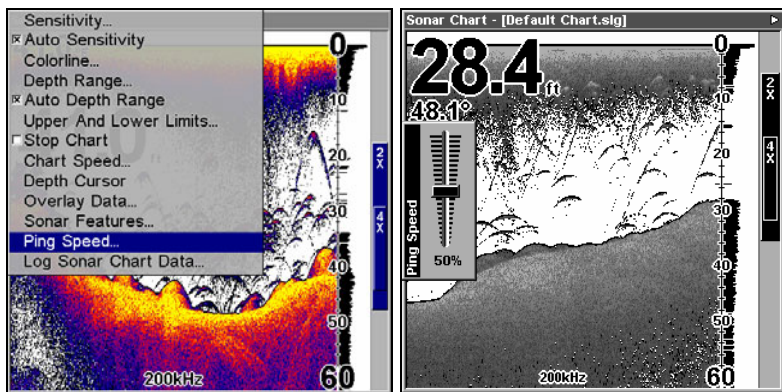

**Sonar Menu with Ping Speed selected (left).  
Ping Speed Control Bar set to its default setting (right).**

### **To change Ping Speed:**

1. From the Sonar Page, press **MENU** |  $\downarrow$  to **PING SPEED** | **ENT**.
2. The Ping Speed Control Bar appears. Press  $\uparrow$  to increase ping speed; press  $\downarrow$  to decrease speed. When it's set at the desired level, press **EXIT**.

### **To adjust Sensitivity:**

1. From the Sonar Page, press **MENU** | **ENT**.
2. The Sensitivity Control Bar appears. Press  $\downarrow$  to decrease sensitivity; press  $\uparrow$  to increase sensitivity. When it's set at the desired level, press **EXIT**. (When you reach the maximum or minimum limit, a tone sounds.)

### **To turn off HyperScroll:**

1. From the Sonar Page, press **MENU** |  $\downarrow$  to **PING SPEED** | **ENT**.
2. The Ping Speed Control Bar appears. Press  $\downarrow$  to decrease ping speed to 50 percent. When it's set at the desired level, press **EXIT**.

When you boost ping speed and switch into HyperScroll, the width of the FasTrack bar graph display doubles in width at the right side of the screen. This allows you to better see the virtually instantaneous sonar returns, just as you would on a flasher sonar unit. For more information on FasTrack, see its entry in this section.

### **Reset Options**

This command is used to reset all features, options and settings to their original factory defaults. This is useful when you have changed several settings and want to return the unit to basic automatic operation.

1. Press **MENU** | **MENU** |  $\downarrow$  to **SYSTEM SETUP** | **ENT** |  $\downarrow$  to **RESET OPTIONS** | **ENT**.
2. Press  $\leftarrow$  to **Yes** | **ENT**.

3. All the menus are cleared and the unit reverts to the Map Page at the 4000 mile zoom range, just as if you had turned it on for the first time. All options have been returned to the factory settings.

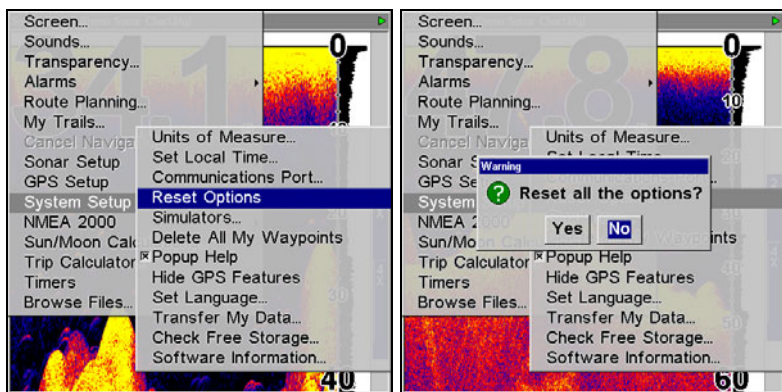

System Setup menu with Reset Options selected (left). The Reset Options dialog box, with "Yes" selected (right).

#### NOTE:

Reset Options does *not* erase any waypoints, routes, plot trails, or sonar logs.

### Reset Water Distance

The sonar chart's Digital Data display option includes a box that shows distance traveled, called Water Distance. This information is calculated from an optional water speed sensor, not the GPS. The Water Distance window can be reset to zero using the Reset Water Distance command.

Press **MENU|MENU|↓** to **SONAR SETUP|ENT|↓** to **RESET WATER DISTANCE|ENT**. The menus are cleared and the water distance is reset to 0.00.

### Set Keel Offset

This unit measures water depth from the face of the transducer. Since the transducer is installed below the water surface, the distance displayed by the digital depth, chart depth scale, chart cursor or fish symbols is *not* the exact water depth. If the transducer is 1 foot below the surface, and the screen shows the water depth as 30 feet, then the actual depth is 31 feet.

On sailboats or other large vessels with deep drafts, the distance between the transducer installation and the keel or lower engine unit can be several feet. In those cases, an inexact depth reading could result in grounding or striking underwater structure.

The Keel Offset feature eliminates the need for the navigator to mentally calculate how much water is under his keel.

Keel Offset lets you calibrate the digital depth, chart depth scale, chart cursor depth and fish symbol depth displayed on the screen. To calibrate the depth indicators, first measure the distance from the face of the transducer to the lowest part of the boat. In this example, we will use 3.5 feet. This will be entered as a *negative* 3.5 feet, which makes the depth indicators perform as if the transducer's lower in the water than it really is.

1. Press **MENU | MENU | ↓** to Sonar Setup **ENT**. Use **↓** to select **SET KEEL OFFSET | ENT**.
2. The Keel Offset dialog box appears. Press **↓** to change the plus (+) sign to a minus (-) sign.
3. Press **→** to the first number, then press **↑** to change the number to 3
4. Press **→** to the second number, then press **↑** to change the number to 5, then press **EXIT**. The depth indicators now accurately show the depth of water beneath the keel.

#### **NOTE:**

If knowing the exact depth of water beneath the keel is less important, you can calibrate the depth indicators so that they show the actual water depth from surface to bottom. To do this, first measure the distance from the face of the transducer up to the surface (the water line on the boat). In this example, we will use 1.5 feet. This will be entered as a *positive* 1.5 feet, which makes the depth indicators perform as if the transducer's higher in the water than it really is.

1. Press **MENU | MENU | ↓** to Sonar Setup **ENT**. Use **↓** to select **SET KEEL OFFSET | ENT**.
2. The Keel Offset dialog box appears with a plus (+) sign at the front of the box.
3. Press **→** to the first number, then press **↑** to change the number to 1.
4. Press **→** to the second number, then press **↑** to change the number to 5, then press **EXIT**. The depth indicators now accurately show the water depth from surface to bottom.

## **Sensitivity & Auto Sensitivity**

The sensitivity controls the ability of the unit to pick up echoes. Sensitivity can be adjusted, because water conditions vary greatly. A low sensitivity level (from zero to 50 percent) excludes much of the bottom information, fish signals, and other target information.

High sensitivity levels let you see this detail, but it can also clutter the screen with many undesired signals. Typically, the best sensitivity level shows a good solid bottom signal with Colorline and some surface clutter.

### **Automatic Sensitivity**

The default sensitivity mode is automatic. The unit bases the sensitivity level on water depth and conditions. When the unit is in the automatic mode, sensitivity is automatically adjusted to keep a solid bottom signal displayed, plus a little more power. This gives it the capability to show fish and other detail.

However, situations occur when it becomes necessary to increase or decrease the sensitivity. This typically happens when you wish to see more detail, so an increase in sensitivity is indicated. Or, wave action and boat wakes can create enough tiny air bubbles to clutter much of the water column. In that case, a decrease in sensitivity is indicated to reduce some of the clutter.

The control bar used to adjust sensitivity up or down is the same whether the unit is in the automatic or manual mode. In automatic you can adjust sensitivity up to 100 percent but the unit will limit your *minimum* setting. In auto, the unit will continue to make small adjustments, allowing for the setting you selected.

In manual mode, you have *complete* control over sensitivity, with the ability to set it anywhere from zero to 100 percent. Once you select a level in manual, the unit will continue to use that exact sensitivity setting until you change it or revert to auto mode.

### **To adjust sensitivity in auto mode:**

1. Press **MENU | ENT**.
2. The Sensitivity Control Bar appears. Press ↓ to decrease sensitivity; press ↑ to increase sensitivity. When it's set at the desired level, press **EXIT**. (When you reach the maximum or minimum limit, a tone sounds.)

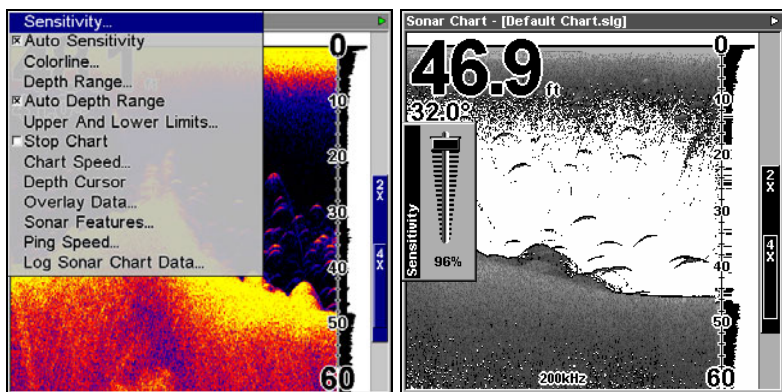

Sonar Menu with Sensitivity selected (left). The Sensitivity Control Bar (right).

**To adjust sensitivity in manual mode:**

1. First, turn off Auto Sensitivity: from the Sonar Page, press **MENU** | ↓ to **AUTO SENSITIVITY** | **ENT**.
2. Press ↑ to **SENSITIVITY** | **ENT** and the Sensitivity Control Bar appears. Press ↓ or ↑ to pick a different sensitivity setting. When it's set at the desired level, press **EXIT**.

**To turn Auto Sensitivity back on:**

From the Sonar Page, press **MENU** | ↓ to **AUTO SENSITIVITY** | **ENT** | **EXIT**.

**NOTE:**

To return to the original factory setting for Auto Sensitivity, see the entry in this section on Reset Options. If sensitivity is in manual mode, the Reset Options command will switch back to Auto and reset the factory setting at the same time.

**Tip:**

For quicker sensitivity adjustments, try leaving the Sensitivity Control Bar on the screen as the chart scrolls. You can see the changes on the screen as you press the up or down arrows. This is handy when there's a lot of clutter in the water, and you are matching the sensitivity to rapidly changing water conditions.

**Sonar Chart Mode**

The default color scheme for the sonar chart is the white background, but we offer other variations to suit your viewing preferences. The chart can be displayed in grayscale, reverse grayscale, blue background, white background, nightview, iceview, or bottom color tracking.

### To change the chart mode color scheme:+

1. From the Sonar Page, press **MENU** | ↓ to **SONAR FEATURES** | **ENT**.
2. Press ↓ to **SONAR CHART MODE** | **ENT**.
3. Press ↓ or ↑ to *Mode Name* | **ENT**.
4. Press **EXIT** | **EXIT** to return to the Sonar Page.

## Sonar Page & Sonar Chart Display Options

The Pages Menu offers five chart display options for dual-frequency models and four options for single-frequency models. To access them, press **PAGES** | ← or → to **SONAR** | ↓ to *Option Name* | **EXIT**.

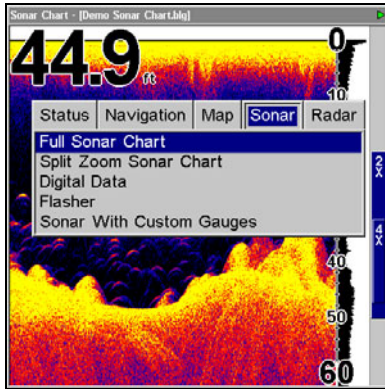

Pages Menu showing sonar chart display options.

### Full Sonar Chart

This is the default mode used when the unit is turned on for the first time or when it's reset to the factory defaults.

The bottom signal scrolls across the screen from right to left. Depth scales on the right side of the screen aid in determining the depth of targets. The line at the top of the screen represents the surface. The bottom depth and surface temperature (if equipped with a temperature sensor or a transducer with a temp sensor built in) show at the top left corner of the screen.

The FasTrack™ display shows just to the right of the scale. This changes all echoes into short horizontal bars, replicating a flasher sonar. The zoom bar on the far right shows the area that's zoomed when the zoom is in use. (See the Zoom section for more information.)

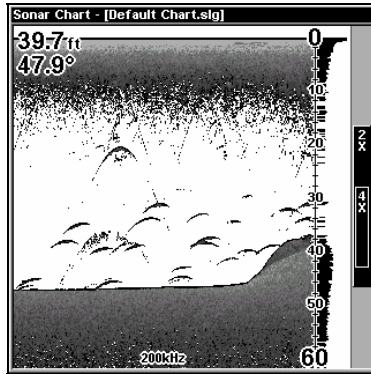

**Full Sonar Chart.** The Overlay Data (depth and water temperature) are both set to the small text size.

### Split Zoom Sonar Chart

A split chart shows the underwater world from the surface to the bottom on the right side of the screen. The left side shows an enlarged version of the right side. The zoom range shows in the bottom left corner.

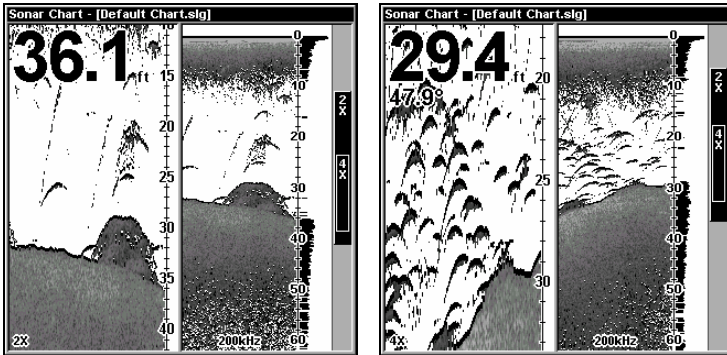

**Split Zoom Sonar Chart.** The left window is zoomed 2X in the first image (left). The left window is zoomed 4X in the second image (right).

### Split Frequency Sonar Chart (LMS-527cDF only)

This page shows sonar data from the 50 kHz transducer on the left side of the screen and data from the 200 kHz transducer on the right side. All other functions and features are the same as the Full Chart page. You can adjust the sensitivity in each window.

#### To adjust sensitivity in auto mode:

1. Press **MENU | ENT**.
2. The unit asks which window (50kHz or 200kHz) you would like to adjust. Press ← or → to select the one you want | **ENT**.

3. The Sensitivity Control Bar appears. Press ↓ to decrease sensitivity; press ↑ to increase sensitivity. When it's set at the desired level, press **EXIT**. (When you reach the maximum or minimum limit, a tone sounds.)

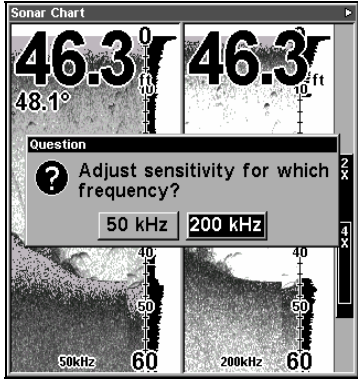

The Split Frequency Sonar Chart page allows you to adjust sensitivity separately for each window.

**Digital Data/Chart**

This mode shows the chart on the right side of the screen. The left side has five digital data boxes containing: Water Depth; Water Speed (from an optional speed sensor); Water Distance (distance traveled or log, it also requires a speed sensor); Surface Water Temperature and Voltage.

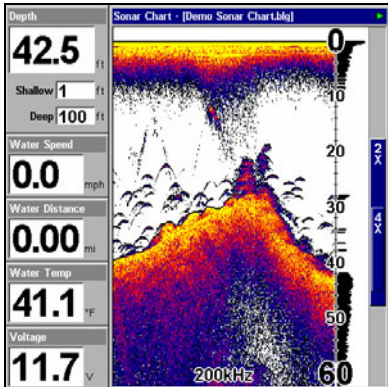

Digital Data/Chart

**Customize Page Displays**

Every Page display option except Full Map (on the Map Page) has customizable data boxes to provide constant on-screen information.

The data available from your unit is divided into categories in the Data Viewer menu. These categories include GPS Data, Navigation, Trip



Calculator, Time, Sonar Data and Miscellaneous Data. You can select items from any of these categories for display in any data box — the category divisions are only there to help you sort through the information.

**To change the information displayed in a data box:**

1. On the Page display you wish to change, press **MENU** | ↓ to **CUSTOMIZE** | **ENT**. A data box name flashes, indicating it is selected.
2. Press **ENT** to change the box or hit ↑, ↓, → or ← to select another box, then press **ENT**. You'll see a list of categories with "+" or "-" symbols next to each category. A category with a "+" is *expandable*, meaning its contents are hidden.

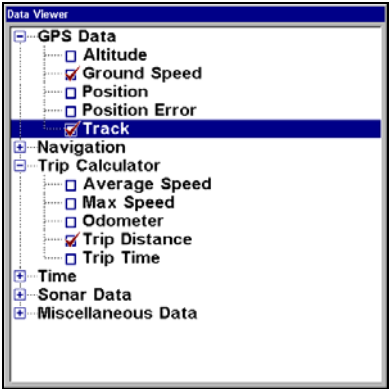

**Customize Menu, with "GPS Data" and "Navigation" categories expanded.**

3. Selecting the category name and pressing **ENT** will show the category's contents, so you can choose items within it. An expanded category (one with a "-" next to its name) can be collapsed to hide its contents. Just select the category name and press **ENT**.
4. Expand any categories that might contain data you want to display. Then press ↓ ↑ to select a different data option.
5. With the new option highlighted, press **ENT** to switch the contents of the box to the new data type, then press **EXIT**.
6. You can now select another box to change. When you are finished with the settings, press **EXIT** again to end the Customize command, and the box name stops flashing.

A Page display can show a limited number of data boxes. You can not turn them off or add more data boxes.

## Flasher

The Flasher sonar page option represents a flasher style sonar combined with a scrolling chart. A circular dial shows all returning echoes at a high screen refresh rate. It uses the Colorline feature to show weaker targets as lighter colors. The bottom depth is also shown as a black bar across the outer circle. You can adjust the size of the chart and the flasher windows by using the Resize Window command, which is described in Sec. 6.

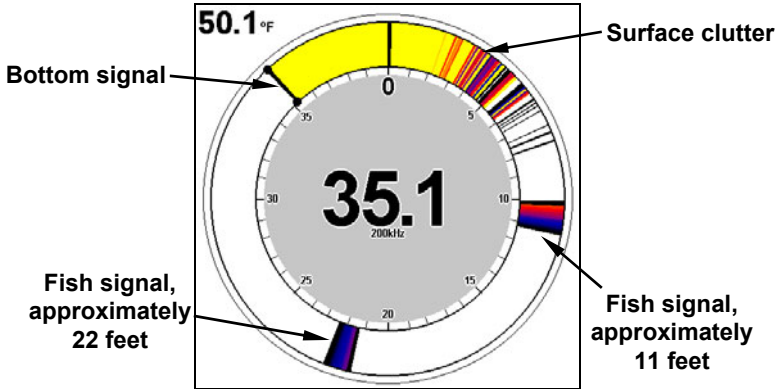

Flasher page.

## Sonar with Custom Gauges

The Sonar with Custom Gauges page has a split screen with sonar on the right side, digital gauge information on the left side. The two windows can be resized to make one side bigger than the other or may be set up to split the screen evenly.

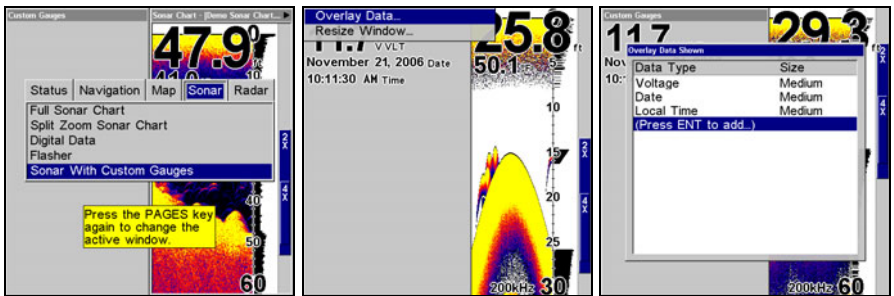

Sonar with Custom Gauges selected on the Pages menu (left). To change custom gauge information, access overlay data on the Custom Gauges menu (center). Overlay Data shown menu (right).

### To customize digital gauge display:

1. Press **PAGES**, highlight **SONAR WITH CUSTOM GAUGES** and press **ENT**.

2. Press **MENU**, select **OVERLAY DATA** and press **ENT**. The Overlay Data shown menu will appear.
3. Highlight (**PRESS ENT TO ADD...**) and press **ENT** to open the Data Viewer menu with three expandable data categories: Time, Sonar Data and Sensor Data.
4. Highlight the desired data category and press **ENT**, which will expand the list, revealing several subcategories with checkboxes next to them.
5. Select the desired subcategory and press **ENT**, which will place a checkmark in the checkbox, showing the selected data is set for display.
6. If you want to display other data types, repeat Steps 4 and 5. Press **EXIT** repeatedly to get back to the Sonar with Custom Gauges page. The data you selected will now be displayed in the gray area on the left side of the screen.

**To change Overlay data size:**

1. From the Sonar with Custom Gauges page, press **MENU SELECT OVERLAY DATA** and press **ENT**. The Overlay Data Shown menu will appear.
2. Highlight the *Data Type* you want to resize, then use ← → to set the data to the desired size to one of four options: Off, Small, Medium, Large and Enormous.



**Local Time is set to medium size (left). The size of Local Time data has been changed to Enormous (right).**

3. To change the size of another Data Type, repeat the steps above. To return to the Sonar with Custom Gauges display, press **EXIT**.

## To resize Sonar and Custom Gauge windows:

1. From the Sonar with Custom Gauges page, press **MENU**, select **RESIZE WINDOW** and press **ENT**.
2. Use **← →** to increase or decrease the size of each window. Press **EXIT**.

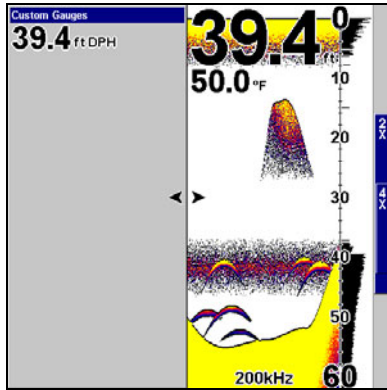

When the Resize Windows command is active, two arrows will appear between the two windows.

## Map with Sonar Split Screen

There is a page mode that splits the screen in half, with the map on the left and the sonar on the right. This screen option can be found on the Pages Menu under the Map Page category.



Full Map page (left). Pages Menu with the Map option list (center). The Map with Sonar screen (right).

When the split screen is activated, you need to specify which side of the display is the active menu. To do this, press **PAGES | PAGES**. The window with the blue title bar at the top of the screen is the active window. To switch back, just press **PAGES | PAGES** again.

# Sonar Simulator

This unit has a built-in simulator that lets you run it as if you were on the water. All sonar features and functions are useable. When in simulator mode, you will see the chart file name in the Sonar Page title bar and a play symbol will flash on and off at the right end of the title bar.

## To use the simulator:

1. From the Sonar Page, press **MENU | MENU | ↓** to **SYSTEM SETUP | ENT | ↓** to **SIMULATORS | ENT**.

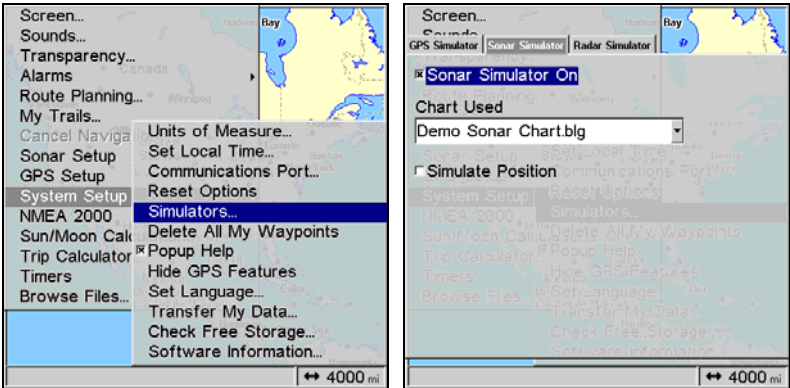

System Setup menu with Simulators selected (left). Sonar Simulator page with Sonar Simulator On highlighted (right). The checkbox next to Sonar Simulator On is checked (turned on).

## NOTE:

With Simulate Position checked, the simulator will automatically run the GPS simulator (if GPS data was recorded with the sonar log).

2. Press **→** to highlight **SONAR SIMULATOR** tab. To turn on the simulator, highlight **SONAR SIMULATOR ON** and press **ENT**, which will place an **X** in the checkbox. Repeat these steps to turn off the simulator.
3. Press **EXIT** repeatedly to return to the main display.

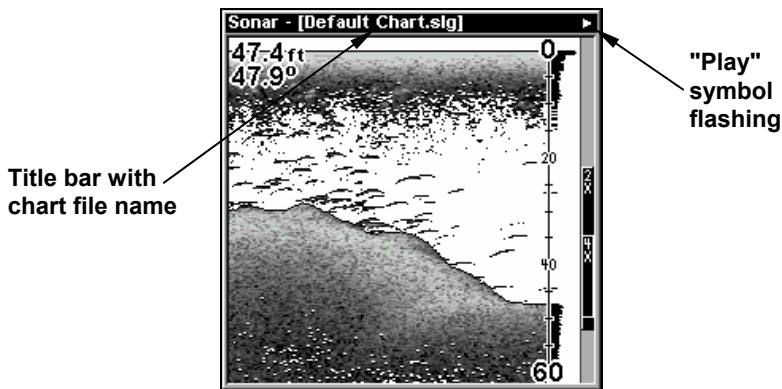

Sonar Page, playing a recorded sonar chart in Sonar Simulator mode.

**Tip:**

The Sonar Simulator can use sonar charts that you or a friend have recorded (logged) on a MMC card. (To see how, read the entry in this section on Log Sonar Chart Data.) To play back your own sonar chart, make sure the MMC containing the chart is installed, then:

1. Press **MENU | MENU | ↓** to **SONAR SETUP | ENT | ↓** to **SONAR SIMULATOR | ENT**.
2. Press **↓** to **CHART USED | ENT**.
3. Press **↓** or **↑** to select *chart name* | **ENT | ↑** to **SONAR SIMULATOR ON | ENT | EXIT**.

While you're in the Sonar Simulator menu, don't forget to check Simulate Position if you want to run the sonar and GPS simulators simultaneously. As you review sonar logs, you can create waypoints to mark the sites you want to revisit.

While the simulator is running, you can switch from one chart log to another by opening the Sonar Simulator menu and using the instructions in step 2 to select a different chart.

**Tip:**

There's more than one way to play a recorded sonar chart. You can also turn on the simulator from the MMC files list. Here's how:

1. Press **MENU | MENU | ↓** to **BROWSE MMC FILES | ENT | ENT**.
2. Press **↓ | ↑** to *file name* | **ENT | ↓** to **PLAY | ENT | EXIT**.

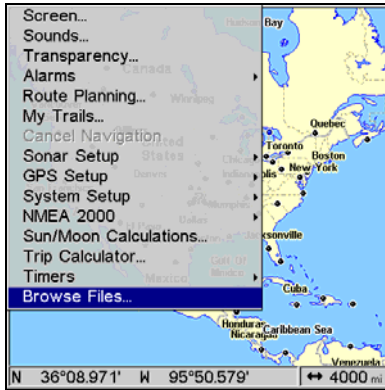

Select Browse MMC Files from the Main Menu.

**NOTE:**

If you turn on your unit before attaching a transducer, it may enter a demo mode. The words "demo mode" flash on the bottom of the screen and a sonar chart plays much like the simulator. Unlike the simulator, the demo mode is for demonstration only, and will automatically stop as soon as you turn on the unit with a transducer attached. The simulator will continue to function normally.

**Stop Chart**

If you are running multiple units on a boat or using this unit in a car, there are times when you may want to turn off the sonar. This command turns off the sonar and stops the chart from scrolling. Sonar restarts automatically each time you turn on your unit.

1. From a Sonar Page, press **MENU** | ↓ to **STOP CHART** | **ENT** | **EXIT**. Repeat this step to restart the chart.

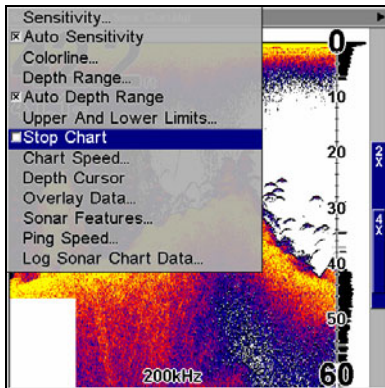

Sonar Menu with Stop Chart command selected. The box is unchecked, indicating that the chart is scrolling across the screen.

# Surface Clarity

The markings extending downward from the zero line on the chart are called "surface clutter." These markings are caused by wave action, boat wakes, temperature inversion and more.

The surface clarity control reduces or eliminates surface clutter signals from the display. It does this by changing the sensitivity of the receiver, decreasing it near the surface and gradually increasing it as the depth increases.

There are three levels of surface clarity available: low, medium, or high. It can also be turned off. The default level is off.

## To adjust the Surface Clarity level:

1. From the Sonar Page, press **MENU** | ↓ to **SONAR FEATURES** | **ENT**.

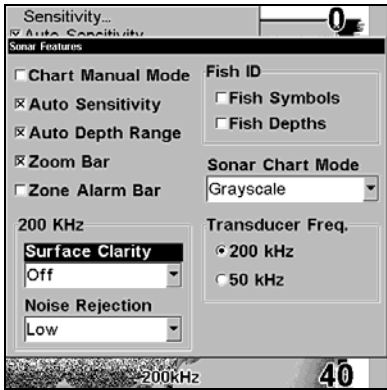

Sonar Features menu with Surface Clarity selected.

2. Press ↓ to **SURFACE CLARITY** | **ENT**.
3. Press ↓ or ↑ to select *clarity level* | **EXIT** | **EXIT** | **EXIT**.



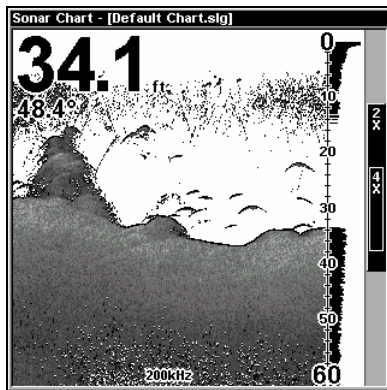
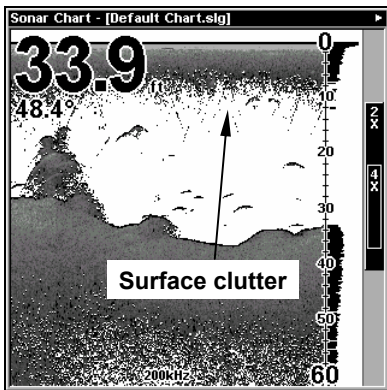

In the illustration at left, Surface Clarity is turned off.  
The right view shows Surface Clarity set at High.

## Transparency

Use the transparency menu to adjust the transparency of menu windows. A high transparency allows you to continue monitoring the screen's display while adjusting feature settings, though the text of the menus may fade until it is unreadable. A low transparency will usually make menu text easier to read, at the cost of watching your display.

Experiment with this feature until you find the right level of transparency for your eyes.

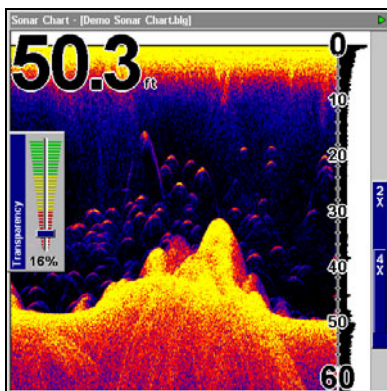
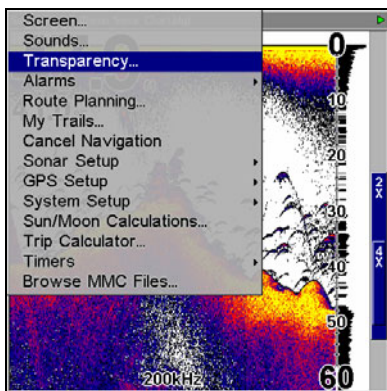

Main Menu with Transparency command selected. Transparency control bar (right).

### To adjust Menu Transparency level:

Press **MENU | MENU | ↓** to **TRANSPARENCY | ENT**. The **TRANSPARENCY** slider bar appears. Press **↑** or **↓** to move the bar. The lower end of the scale makes the menu opaque; the upper end is maximum transparency.

## Upper and Lower Limits

See the entry in this section for Depth Range - Upper and Lower Limits

## Zoom & Zoom Bar

"Zooming" the display is a common, fast and easy method used to enlarge small detail, fish signals and the bottom with its associated structure. This unit lets you zoom the display quickly and easily by pressing the Zoom In key, **ZIN**.

Pressing **ZIN** once doubles the size (2X) of all echoes on the screen. Pressing it again quadruples the size (4X). The zoom bar on the far right side of the screen shows which echoes will be displayed on the screen when the **ZIN** key is pressed.

For example, pressing the **ZIN** key once will enable a 2X zoom which will show all echoes that are between the top and bottom of the 2X zoom bar. Pressing the key again will give a 4X zoom and only the echoes between the top and bottom of the 4X bar will show on the screen.

Press the Zoom Out key, **ZOUT**, to return the display to the normal mode.

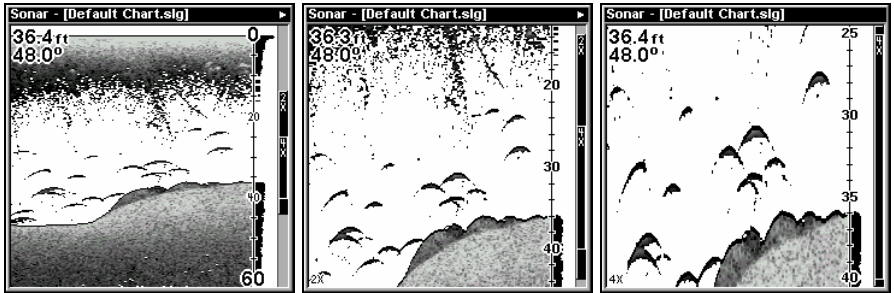

Sonar Page with a normal view (left). The second image (center) is showing the same view zoomed 2X. The third image (right) is showing the same view zoomed 4X

## Zoom Pan

Your unit has the handy ability to quickly zoom in on any portion of the water column with just the touch of an arrow key. The Zoom Pan feature lets you rapidly move the zoomed area up and down to different depths. By "pointing" your zoom at different portions of the chart as it scrolls, you can get a good, close-up look at structure or cover below you.

To use Zoom Pan, switch to a manual depth Range setting (see page 67) and turn on 2X or 4X Zoom. Then, simply press  $\uparrow$   $\downarrow$  to pan up and down the water column.

## Section 5: Sonar Troubleshooting

If your unit is not working, or if you need technical help, please use the following troubleshooting section before contacting the customer service department. It may save you the trouble of returning your unit for repair. For contact information, refer to the last page, just inside the back cover of this manual.

### **Unit won't turn on**

1. Check the power cable's connection at the unit. Also check the wiring.
2. Make sure the power cable is wired properly. The red wire connects to the positive battery terminal, black to negative or ground.
3. Check the fuse.
4. Measure the battery voltage at the unit's power connector. It should be at least 10 volts. If it isn't, the wiring to the unit is defective, the battery terminals or wiring on the terminals are corroded, or the battery needs charging.

### **Unit freezes, locks up, or operates erratically**

1. Electrical noise from the boat's motor, trolling motor, or an accessory may be interfering with the sonar unit. Rerouting the power and transducer cables away from other electrical wiring on the boat may help. Route the sonar unit's power cable directly to the battery instead of through a fuse block or ignition switch
2. Inspect the transducer cable for breaks, cuts, or pinched wires.
3. Check the transducer and power connector. Make sure it's securely plugged in to the unit.

### **Weak bottom echo, digital readings erratic, or no fish signals**

1. Make sure the transducer is pointing straight down. Clean the face of the transducer. Oil, dirt and fuel can cause a film to form on the transducer, reducing its effectiveness. If the transducer is mounted inside the hull, be sure it is shooting through only one layer of fiberglass and that it is securely bonded to the hull. When attaching a transducer to the inside of a hull, **ONLY** use the epoxy available from LEI (order information is inside the back cover). Do **NOT** use RTV silicone rubber adhesive or any other type of epoxy. The LEI epoxy is specially formulated so that it will cure properly for shoot-through applications.
2. Electrical noise from the boat's motor can interfere with the sonar. This causes the sonar to automatically increase its discrimination or noise rejection feature. This can cause the unit to eliminate weaker signals such as fish or even structure from the display.
3. The water may be deeper than the sonar's ability to find the bottom.

If the sonar can't find the bottom signal while it's in the automatic mode, the digital sonar display will flash continuously. It may change the range to limits far greater than the water you are in. If this happens, place the unit in the manual mode, then change the range to a realistic one, (for example, 0-100 feet) and increase the sensitivity. As you move into shallower water, a bottom signal should appear.

4. Check the battery voltage. If the voltage drops, the unit's transmitter power also drops, reducing its ability to find the bottom or targets.

### **Bottom echo disappears at high speeds or erratic digital reading or weak bottom echo while boat is moving**

1. The transducer may be in turbulent water. It must be mounted in a smooth flow of water in order for the sonar to work at all boat speeds. Air bubbles in the water disrupt the sonar signals, interfering with its ability to find the bottom or other targets. The technical term for this is cavitation.

2. Electrical noise from the boat's motor can interfere with the sonar. This causes the sonar to automatically increase its discrimination or noise rejection feature. This can cause the unit to eliminate weaker signals such as fish or even structure from the display. Try using resistor spark plugs or routing the sonar unit's power and transducer cables away from other electrical wiring on the boat.

### **No fish arches when the Fish I.D. feature is off**

1. Make sure the transducer is pointing straight down. This is the most common problem if a partial arch is displayed.

2. The sensitivity may not be high enough. In order for the unit to display a fish arch, it has to be able to receive the fish's echo from the time it enters the cone until it leaves. If the sensitivity is not high enough, the unit shows the fish only when it is in the center of the cone.

3. Use the Zoom feature. It is much easier to display fish arches when zoomed in on a small range of water than a large one. For example, you will have much better luck seeing fish arches with a 30 to 60 foot range than a 0 to 60 foot range. This enlarges the targets, allowing the display to show much more detail.

4. The boat must be moving at a slow trolling speed to see fish arches. If the boat is motionless, fish stay in the cone, showing on the screen as straight horizontal lines.

### **NOISE**

A major cause of sonar problems is electrical noise. This usually appears on the sonar's display as random patterns of dots or lines. In severe cases, it can completely cover the screen with black dots, or cause the unit to operate erratically, or not at all.

To eliminate or minimize the effects of electrical noise, first try to determine the cause. With the boat at rest in the water, the first thing you should do is turn all electrical equipment on the boat off. Make sure the engine is also off. Turn your sonar on, then turn off Noise Reject [also known as the ASP feature (Advanced Signal Processing)]. Sensitivity should be set at 90-95 percent. There should be a steady bottom signal on the display. Now turn on each piece of electrical equipment on the boat and view the effect on the sonar's display. For example, turn on the bilge pump and view the sonar display for noise. If no noise is present, turn the pump off, then turn on the VHF radio and transmit. Keep doing this until all electrical equipment has been turned on, their effect on the sonar display noted, then turned off.

If you find noise interference from an electrical instrument, trolling motor, pump, or radio, try to isolate the problem. You can usually re-route the sonar unit's power cable and transducer cable away from the wiring that is causing the interference. VHF radio antenna cables radiate noise when transmitting, so be sure to keep the sonar's wires away from it. You may need to route the sonar unit's power cable directly to the battery to isolate it from other wiring on the boat.

If no noise displays on the sonar unit from electrical equipment, then make sure everything except the sonar unit is turned off, then start the engine. Increase the RPM with the gearshift in neutral. If noise appears on the display, the problem could be one of three things; spark plugs, alternator, or tachometer wiring. Try using resistor spark plugs, alternator filters, or routing the sonar unit's power cable away from engine wiring. Again, routing the power cable directly to the battery helps eliminate noise problems. Make sure to use the in-line fuse supplied with the unit when wiring the power cable to the battery.

When no noise appears on the sonar unit after all of the above tests, then the noise source is probably cavitation. Many novices or persons with limited experience make hasty sonar installations which function perfectly in shallow water, or when the boat is at rest. In nearly all cases, the cause of the malfunction will be the location and/or angle of the transducer. The face of the transducer must be placed in a location that has a smooth flow of water at all boat speeds. Read your transducer owner's manual or the Installation instructions (Sec. 2) in this manual for the best mounting position.

# Notes

## Section 6: Basic GPS Operations

This section addresses the unit's *most basic* GPS operations. The tutorials presented in Sec. 6 follow a chronological order. Sec. 7, *Advanced GPS Operations*, will discuss other more advanced functions and utilities.

Before you turn on the unit and find where you are, it's a good idea to learn about the different keys, the four Page screens and how they all work together. BUT, if you just can't wait to get outside, turn to the one-page **Quick Reference** on page 117.

### Keyboard



LMS-527cDF sonar/GPS unit, front view, showing map with sonar split screen, keyboard and access door for the MMC slot.

1. **PWR/LIGHT** (Power & Light) – The PWR key turns the unit on and off and activates the backlight.
2. **PAGES** – Pressing this and the ← → arrow keys (4) switches the unit between the four different page screens. (Satellite Status Page,

Navigation Page, Map Page and Sonar Page.) Each page represents one of the unit's major operation modes.

3. **MENU** – Press this key to show the menus and submenus, which allow you to select a command or adjust a feature. This also accesses search functions for streets, intersections, addresses and highway exits.

4. **ARROW KEYS** – These keys are used to navigate through the menus, make menu selections, move the map cursor and sonar chart cursor and enter data.

5. **ENT/ICONS** (Enter & Icons) – This key allows you to save data, accept values or execute menu commands. It is also used to create event marker icons.

6. **EXIT** – The Exit key lets you return to the previous screen, clear data or close a menu.

7. **WPT** – (Waypoint) The Waypoint key is used to save and recall waypoints, search for waypoints and access the waypoint list. It also launches the Point-of-Interest (POI) search menus and is involved in some navigation functions.

8. **ZOUT** – (Zoom Out) – This key lets you zoom the screen out. On the Sonar Page, this key returns you to a full sonar chart display, showing the entire water column from surface to bottom. On the Map Page, this lets you see a larger geographic area on the map. Less detail is seen as you zoom out.

9. **ZIN** – (Zoom In) – This key lets you zoom the screen in. On the Sonar Page, this key enlarges fish signals and bottom detail. On the Map Page, zooming in lets you see greater detail in a smaller geographic area on the map.

## **Power/lights on and off**

To turn on the unit, press **PWR**. As the unit powers up, the Map Page is displayed first. (To switch to another page, press **PAGES** | ← or → to *Page Name* | **EXIT**.)

To turn on the backlight, press **PWR** again. The unit has three backlight levels to select from. Repeatedly pressing **PWR** will cycle through the backlight settings and turn off the backlight.

Turn off the unit by pressing and holding the **PWR** key for 3 seconds.

## **Main Menu**

The unit has a Main Menu, which contains some function commands and some setup option commands. The tutorial lessons in this section will deal only with functions, the basic commands that make the unit do



something. The GPS will work fine for these lessons right out of the box with the factory default settings. But, if you want to learn about the various options, see Sec. 8, *System Setup and GPS Setup Options*.

You can access the Main Menu from any of the four Page screens by pressing **MENU | MENU**. To clear the menu screen and return to the page display, press **EXIT**.

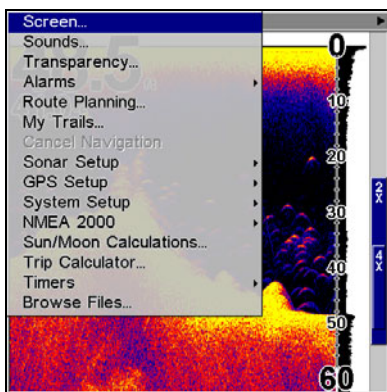

**Main Menu.**

The Main Menu commands and their functions are:

**Screen:** changes the contrast or brightness of the display screen.

**Sounds:** enables or disables the sounds for key strokes and alarms and sets the alarm style.

**Transparency:** adjusts the level of transparency for menus.

**Alarms:** turns GPS or sonar alarms on or off and changes alarm thresholds.

**Route Planning:** used to plan, view or navigate a route.

**My Trails:** shows, hides, creates and deletes plot trails. Also used to navigate or backtrack a trail.

**Cancel Navigation:** turns off the various navigation commands. Used to stop navigating after you have reached your destination waypoint, Point of Interest or map cursor location; or after you reach the end of a route or trail.

**Sonar Setup:** sets various sonar options.

**GPS Setup:** sets various GPS receiver options.

**System Setup:** sets general configuration options.

**NMEA 2000:** provides access to all NMEA 2000 network setup options, including the configuration of devices on the network. For more information, see Section 10: NMEA 2000 Menu.

**Sun/Moon Calculations:** finds the rising and setting time of the sun and the moon.

**Trip Calculator:** shows trip status and statistics.

**Timers:** controls the up timer, down timer and alarm clock settings.

**Browse MMC Files:** this allows you to view the installed MMC card and the files it contains.

## Pages

The unit has four Page displays that represent the five major operating modes. They are the Satellite Status Page, the Navigation Page, Map Page and the Sonar Page. They are accessed by pressing the **PAGES** key, then using → or ← to select a Page. (Clear the Pages menu by pressing **EXIT**.)



Pages Menu showing Map page options.

## Sonar Page

The Sonar Page displays the sonar chart, a view of the water column from the surface to the bottom. The chart scrolls across the screen from right to left, displaying signal echoes that represent fish, structure and the bottom. The Sonar Page is discussed in detail in Sec. 3.

## Satellite Status Page

The Satellite Status Page provides detailed information on the status of the unit's satellite lock-on and position acquisition. To get to the Satellite Status Page: Press the **PAGES** key, then use → or ← to select **STATUS**. (Clear the Pages Menu by pressing **EXIT**.)

No matter what Page you are on, a flashing current position indicator/question mark symbol and flashing GPS data displays indicate that satellite lock has been lost and there is no position confirmed. The Satellite Status Page shows you the quality and accuracy of the current satellite lock-on and position calculation.

## WARNING:

**Do not begin navigating with this unit until the numbers have stopped flashing!**

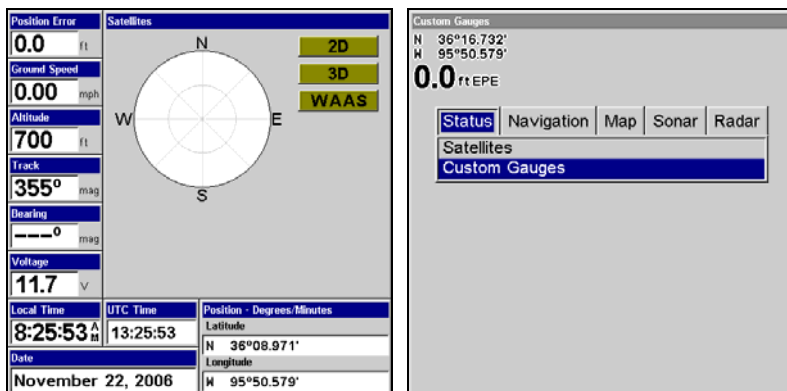

**Satellite Status Page (left). Custom Gauges (right).**

This screen will show a graphical view of the satellites that are in view. Each satellite is shown on the circular chart relative to your position. The point in the center of the chart is directly overhead. The small inner ring represents 45° above the horizon and the large ring represents the horizon. North is at the top of the screen. You can use this to see which satellites are obstructed by obstacles in your immediate area if the unit is facing north.

The GPS receiver will track satellites that are in bold type. The receiver hasn't locked onto a satellite if the number is grayed out, therefore it isn't being used to calculate your position.

Beneath the circular graph will be bar graphs, one for each satellite in view. Since the unit has twelve channels, it can dedicate one channel per visible satellite. The taller the bar on the graph, the better the unit is receiving the signals from the satellite.

You can set up custom digital gauges through the Satellite Status page menu. The Custom Gauges feature allows you to monitor a wide variety of data from one page.

### **To set up Custom Gauge page:**

1. Select the **SATELLITE STATUS** page from the Pages menu, highlight **CUSTOM GAUGES** and press **ENT**.
2. Press **MENU**. **OVERLAY DATA** will be highlighted, so press **ENT**. The Overlay Data shown menu will appear.
3. Highlight **(PRESS ENT TO ADD...)** and press **ENT** to open the Data Viewer menu with five expandable data categories: GPS Data, Navigation, Trip Calculator, Time and Sensor Data.

4. Highlight the desired data category and press **ENT**, which will expand the list, revealing several subcategories with checkboxes next to them.

5. Select the desired subcategory and press **ENT**, which will place a checkmark in the checkbox, showing the selected data is set for display.

6. If you want to display other data types, repeat Steps 4 and 5. Press **EXIT** repeatedly to get back to the Custom Gauges page. The data you selected will now be displayed on the screen.

#### **To change Overlay data size:**

1. From the Custom Gauges page, press **MENU SELECT OVERLAY DATA** and press **ENT**. The Overlay Data Shown menu will appear.

2. Highlight the *Data Type* you want to resize, then use ← → to set the data to the desired size to one of four options: Off, Small, Medium, Large and Enormous.

3. To change the size of another Data Type, repeat the steps above. To return to the Sonar with Custom Gauges display, press **EXIT**.

#### **NOTE:**

One of the data display options for the Satellite Status page is "Position Error" (horizontal position error), which can appear in one of the page's data boxes. If you turn on Position Error, it will show you the expected error from a benchmark location. In other words, if the Position Error box shows 50 feet, then the position shown by the unit is estimated to be within 50 feet of the actual location.

This also gives you an indicator of the fix quality the unit currently has. The smaller the position error number, the better (and more accurate) the fix is. If the position error flashes dashes, then the unit hasn't locked onto the satellites, and the number shown isn't valid. (For details, see the Customize Page Displays entry in Sec. 8.)

The Satellite Status Page has its own menu, which is used for setting various options. (Options and setup are discussed in Sec. 8). To access the Satellite Status Page Menu, from the Status Page, press **MENU**.

#### **Navigation Page**

This screen has a compass rose that not only shows your direction of travel, but also the direction to a recalled waypoint. The page has two options, navigation with digital data and navigation with sonar. To get to the Navigation Page: Press **PAGES** |→ or ← | **NAVIGATION**. Press ↓ or ↑ | **EXIT** to select one of the two menu items.

The navigation screen looks like the one below when you're *not* navigating to a waypoint or following a route or trail. Your position is shown by an arrow in the center of the screen. Your trail history, or

path you've just taken, is depicted by the line extending from the arrow. The arrow pointing down at the top of the compass rose indicates the current track (direction of travel) you are taking.

Track or compass heading indicator, showing direction of travel

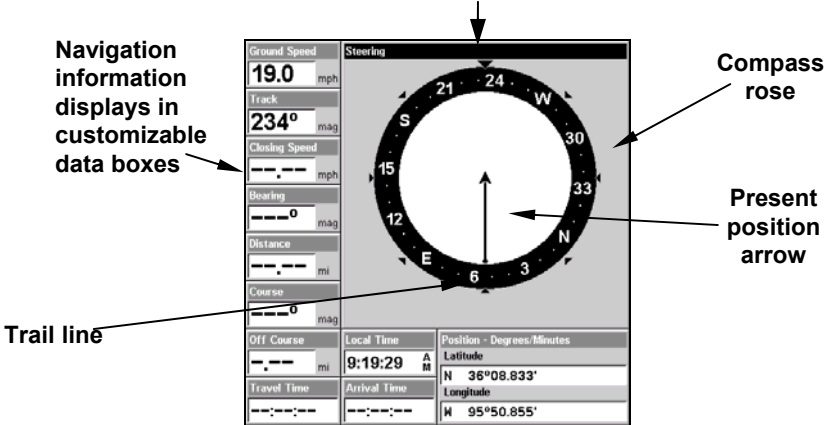

The Navigation with Digital Data Page recording a trail, while traveling southwest. Page looks like this when the unit is not navigating to a waypoint, following a route, or backtracking a trail.

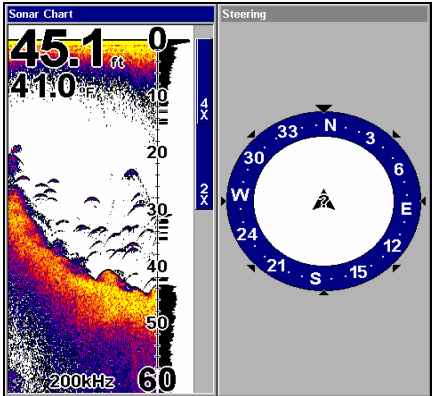

Navigation with Sonar page.

When navigating to a waypoint, your ground speed, track, distance, bearing to the waypoint and course are all displayed.

**NOTE:**

Remember, when the Speed, Track and Position information displays are flashing, satellite lock has not been achieved and no position fix has been determined. A question mark will also flash on the present position arrow in the center of the compass rose.

Speed (ground speed) is the velocity you are making over the ground. (If you wish, you can customize the Speed data box to display Closing Speed instead. Closing Speed is also known as velocity made good. It's the speed that you're making toward the waypoint. For instructions, see the Customize Page Displays entry in Sec. 8.)

Track is the heading, or the current direction you are actually traveling. Bearing is the direction of a line-of-sight from your present position to the destination. No matter what direction you are steering, the Bearing window shows the compass direction straight to the destination from your location at the moment. Distance shows how far it is to the waypoint you're navigating toward.

The Off Course window shows the current cross track error. This shows the distance you are off-course to the side of the desired course line. The course line is an imaginary line drawn from your position when you started navigating to the destination waypoint. The course line is shown on the Navigation Page screen (and the Map Page screen) as a dotted line.

**Left cross track error line**      **Course line**      **Heading arrow**

**Current track or heading, shown in degrees** → 8.0 mph

**Compass bearing to destination** → 265° mag

**Trail line** → 0.30 mi

**Navigation information displays in data boxes** →

|             |              |                            |
|-------------|--------------|----------------------------|
| Off Course  | Local Time   | Position - Degrees/Minutes |
| 0 R ft      | 4:59:41 P M  | Latitude                   |
|             |              | N 36°08.196'               |
| Travel Time | Arrival Time | Longitude                  |
| 0:02:17     | 5:01:58 P M  | W 95°45.500'               |

**Bearing arrow**      **Waypoint symbol**

**Cross track error range (off course indicator)**

**Destination name** → Going To 004

Navigation Page.

The cross track error range is shown on the compass rose as a wide, white, corridor enclosing the course line. The outer edges of this white corridor represent lines that show the current cross track error range. The default for the cross track error range is 0.20 miles.

For example, if the present position symbol touches the right cross track error line, then you are 0.20 miles to the right of the desired course. You need to steer left to return to the desired course.

You can use the **ZIN** or **ZOUT** keys to change the cross track error range. A circular symbol showing your destination (waypoint) appears on the screen as you approach the waypoint, as shown on the screen in the preceding figure.

Travel Time is the time that it will take to reach your destination at your present closing speed. (You can also customize the time data box to show Arrival Time instead. Arrival Time is the local time it will be when you arrive at the destination, based upon your present closing speed and track.)

In the preceding example, the driver is headed west (a  $265^\circ$  track) toward a waypoint  $265^\circ$  (bearing) away. The cross track error range (white corridor) is 0.20 miles either side of the course. The driver is headed toward trail waypoint 4, which is 0.3 miles away. The vehicle is right on course. Traveling at a speed of 8 mph, the driver will arrive at the waypoint in 2 minutes, 17 seconds.

The Navigation Page has its own menu, which is used for some advanced functions and for setting various options. (Options and setup are discussed in Sec. 8). To access the Navigation Page Menu, from the Navigation Page, press **MENU**.

## Map Page

The Map Page screens show your course and track from a bird's-eye view. By default, this unit shows the map with north always at the top of the screen. (This can be changed. See the topic *Map Orientation*, in Sec. 8.) If you're navigating to a waypoint, the map also shows your starting location, present position, course line and destination. You, however, don't have to navigate to a waypoint to use the map.

Map Page is the default screen that appears when you turn on the unit. To get to the Map Page from another page: Press **PAGES** | ← or → to **MAP** | **EXIT**. When the Map Page is displayed, a screen similar to the following figures appears.

The arrow in the center of the screen is your present position. It points in the direction you're traveling. The solid line extending from the back of the arrow is your plot trail, or path you've taken.

The map zoom range is the distance across the screen. This number shows in the lower right corner of the screen. In the first of the following example figures, the range is 4,000 miles from the left edge of the map to the right edge of the map.

The Zoom In and Zoom Out keys zoom the map to enlarge or reduce its coverage area and the amount of mapping detail shown. There are 39 available map zoom ranges, from 0.02 miles to 4,000 miles.



**Map Page opening screen (left). Set to 100-mile zoom (center) and 10-mile zoom (right). Over Zoomed means you have reached the detail limits in an area covered only by the basic background map. Zooming in closer will reveal no more map detail because a high-detail custom map has not been loaded on the MMC for this area.**

If you're using only the factory-loaded background map, the maximum zoom range for showing *additional* map detail is 20 miles. You can continue to zoom in closer, but the map will simply be enlarged without revealing more map content (except for a few major city streets.) Load your own high-detail custom map made with MapCreate (or a pre-made FreedomMap from LEI), and you can zoom in to 0.02 miles with massive amounts of accurate map detail.



**Map Pages with high-detail MapCreate map of an urban area loaded on the MMC. Arterial streets appear at the 4-mile zoom range (left) with a few Point of Interest icons visible. Numerous dots representing Points of Interest are visible at the 2-mile range (center) along with minor streets.**

**At a 0.4-mile zoom (right), you can see an interstate highway with an exit, major and minor streets as well as Point of Interest icons.**

### **Background map vs. MapCreate map content**

The background map includes: low-detail maps of the whole world (containing cities, major lakes, major rivers, political boundaries); and medium-detail maps of the United States.

The medium-detail U.S. maps contain: all incorporated cities; shaded metropolitan areas; county boundaries; shaded public lands (such as



national forests and parks); some major city streets; Interstate, U.S. and state highways; Interstate highway exits and exit services information; large- and medium-sized lakes and streams; and more than 60,000 navigation aids and 10,000 wrecks and obstructions in U.S. coastal and Great Lakes waters.

MapCreate custom maps include massive amounts of information not found in the background map. MapCreate maps contain the searchable Points of Interest database, all the minor roads and streets, all the landmark features (such as summits, schools, radio towers, etc.); more rivers, streams, smaller lakes and ponds and their names.

What's more important is the large scale map detail that allows your GPS unit to show a higher level of position accuracy. For example, the background map would show you the general outline and approximate shape of a coastline or water body, but the higher detail in MapCreate shows the shoreline completely and accurately (finer detail). Many smaller islands would not be included in the background map, but are in MapCreate.

**NOTE:**

Available through LEI Extras (look inside back cover for accessory ordering information), FreedomMaps are pre-made maps that contain all of the same information available in a custom MapCreate map, without any work on your part.

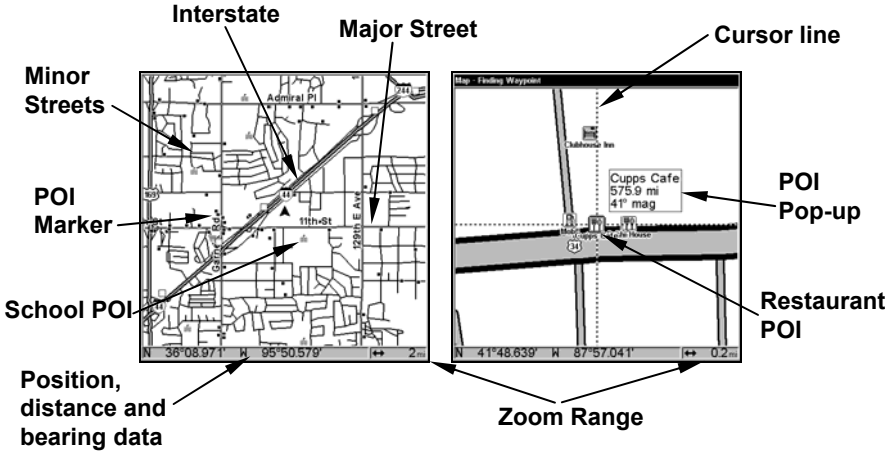

When the map is zoomed out far enough, most POIs appear as square dots. As you zoom in closer, the symbols become readable icons. In the 0.2 mile zoom example (right), the cursor has selected the Cupps Café POI, which triggers a pop-up box with the POI name. This pop-up box works on POIs at any zoom range.

## Tip:

In some urban areas, businesses are so close to one another that their POI icons crowd each other on the screen. You can reduce screen clutter and make streets and other map features easier to see by simply turning off the *display* of POIs you're not watching for. (To see how, check the text on Map Detail Category Selection, page 162. It shows how to use the Map Categories Drawn menu to turn individual POI displays off and on.) Even though their display is turned off, you can still search for POIs and their icons will pop-up when your unit finds them for you.

The Map Page has its own menu, which is used for several functions and for setting various options. To access the Map Page Menu, from the Map Page, press **MENU**.

The Pages Menu also offers several map display options under the Map Page category. To access them, press **PAGES** | ← → to **MAP** | ↓ to *Option* | **EXIT**.

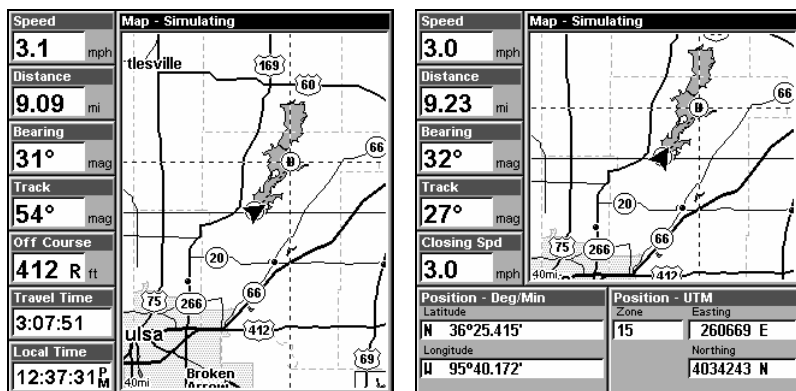

Digital Data map page (left). Two Position Formats page (right).

In pages that have two major windows (such as two maps) you can toggle back and forth between the two windows by pressing **PAGES** | **PAGES**. This allows you to change which map your cursor moves on, and which map the menu operates on. The window with the blue title bar is the active window.



Pages Menu with Two Map option selected (left). The windows are in a horizontal position. Map Page with two vertical windows (right).

Resize Window is another feature for pages that have two major windows. You can change the horizontal size of the windows to suit your viewing preference.

1. From any two-window display, press **MENU** |  $\downarrow$  to **RESIZE WINDOW** | **ENT**.
2. Four flashing arrows appear along the centerline dividing the two windows. The windows will be in a horizontal position by default, so press  $\uparrow$   $\downarrow$  to resize the windows. Or, if you want to realign the windows vertically, use  $\leftarrow$   $\rightarrow$  to switch the windows from a horizontal position to a vertical position. After the windows are in a vertical position, press  $\leftarrow$   $\rightarrow$  to resize the windows. Press **EXIT** to clear the menu.
3. To change the window size again or revert to the original display, just follow the steps above. You can also use the Reset Options command to revert to the factory default.

### Map with Sonar

The Map with Sonar page evenly splits the screen between the map view and sonar view. The windows may be resized to fit your preference.

#### To resize Map with Sonar windows:

1. Press **PAGES**, highlight **MAP**, select **MAP WITH SONAR** and press **ENT**.
2. Press **MENU**, highlight **RESIZE WINDOWS** and press **ENT**. Two horizontal arrows will appear on the screen.
3. Use  $\leftarrow$   $\rightarrow$  to increase or decrease the size of the windows. Press **EXIT** to return to normal operation.

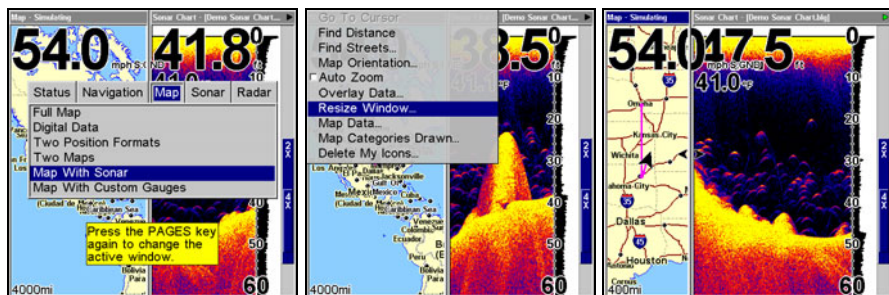

Map with Sonar highlighted on Pages menu (left). Resize Windows selected on Map with Sonar menu (center). Dual arrows are shown as windows are resized (right).

### Map with Custom Gauges

The Map with Custom Gauges page has a split screen with a map on the right side and digital gauge information on the left side. The two windows can be resized to make one side bigger than the other or may be set up to split the screen evenly.

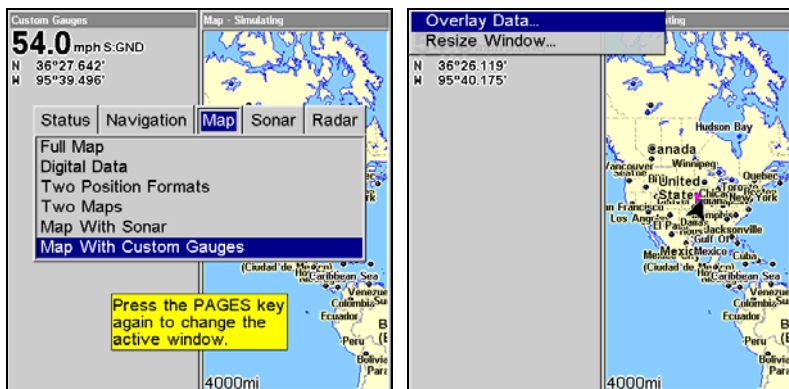

Map with Custom Gauges highlighted on Pages menu (left). Overlay Data selected on Map with Custom Gauges menu (right).

### To customize digital gauge display:

1. Press **PAGES**, highlight Map, select **MAP WITH CUSTOM GAUGES** and press **ENT**.
2. Press **MENU**, select **OVERLAY DATA** and press **ENT**. The Overlay Data shown menu will appear.
3. Highlight (**PRESS ENT TO ADD...**) and press **ENT** to open the Data Viewer menu with five expandable data categories: GPS Data, Navigation, Trip Calculator, Time, Sonar Data and Sensor Data.

4. Highlight the desired data category and press **ENT**, which will expand the list, revealing several subcategories with checkboxes next to them.

5. Select the desired subcategory and press **ENT**, which will place a checkmark in the checkbox, showing the selected data is set for display.

6. If you want to display other data types, repeat Steps 4 and 5. Press **EXIT** repeatedly to get back to the Map with Custom Gauges page. The data you selected will now be displayed in the gray area on the left side of the screen.

**To change Overlay data size:**

1. From the Map with Custom Gauges page, press **MENU** select **OVERLAY DATA** and press **ENT**. The Overlay Data Shown menu will appear.

2. Highlight the *Data Type* you want to resize, then use ← → to switch the data setting to one of the following four options: Off, Small, Medium, Large and Enormous.

3. To change the size of another Data Type, repeat the steps above. To return to the Sonar with Custom Gauges display, press **EXIT**.

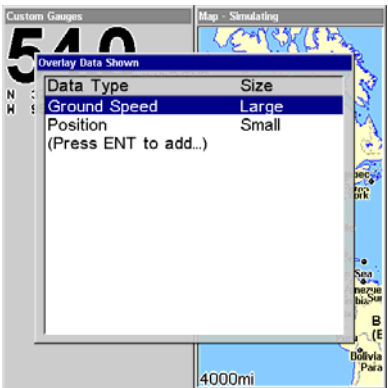
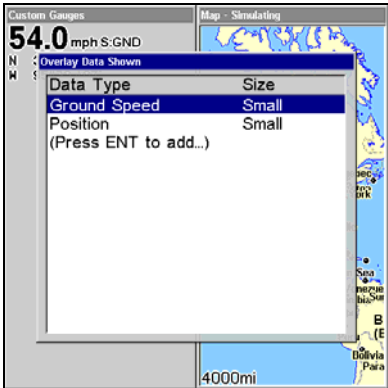

Ground Speed is set to small size (left). The size Ground Speed data has been changed to Large (right).

## Radars

When you access the Radar Page, the screen will switch to the radar display. Information on radar installation and radar operation are included in two documents that come packed with Lowrance radar units: *Radars and RIM 100 Radar Interface Module Installation Instructions* and *Radars Operation Instruction Manual*. Refer to these documents for information on your radar unit.

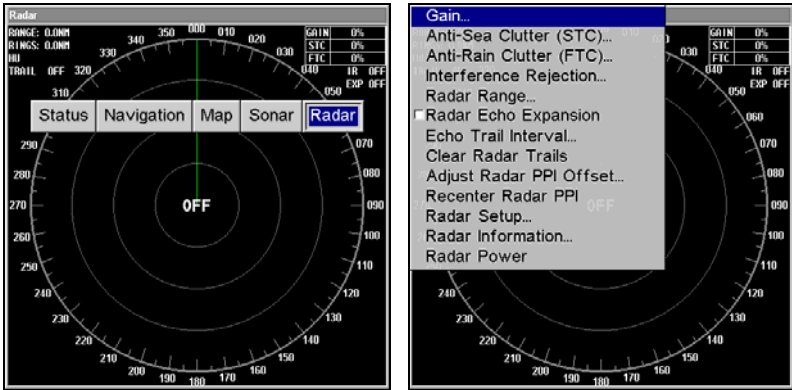

**Radar Page (left) with Radar menu display (right).**

**To access Radar Page:**

1. Press **PAGES**, highlight the **RADAR** tab and press **ENT**.
2. Press **MENU** to open the Radar menu. Press **EXIT** to return to the radar display.

The following page contains a 12-step quick reference for the most basic GPS operations.

## Basic GPS Quick Reference

*Start outdoors, with a clear view of the open sky. As you practice, try navigating to a location at least a few blocks away. Navigation in too small an area will constantly trigger arrival alarms.*

1. Depress the **PWR** key to turn on the unit.
2. Opening screen displays map of North America at the 4,000 mile zoom range. Rotate through the four main Page screens (Map Page, Satellite Status Page, Navigation Page and Sonar Page) by pressing **PAGES** | ← or → to select *Page Name* | **EXIT**. Switch Pages to display Satellite Status Page.
3. Wait while unit locates satellites and calculates current position. Process is visible on Satellite Page. This takes an average of 1 minute or less under when it is unobstructed by terrain or structures. When the unit acquires position, a tone sounds and a position acquired message appears.
4. With position acquired, press **PAGES** key to display the Map Page, which gives you a bird's eye view. You can manipulate the map by:
  - Zoom in** closer to see greater detail: press **ZIN** (zoom in key.)
  - Zoom out** to see more area, less detail: press **ZOUT** (zoom out key.)
  - Scroll** map north, south, east or west using arrow keys ↑ ↓ → ← .To stop scrolling and return to current position on map, press **EXIT** key.
5. Set a waypoint (*Wpt 001*) at your current position so you can navigate back here: press **WPT** | **WPT**. Waypoint symbol and "001" appears.
6. Zoom/scroll map to find a nearby object or location to go to. Use arrow keys to center cursor crosshairss over the map object or location.
7. Navigate to the selected destination: press **MENU** | **ENT** | **EXIT**. Follow dotted course line on Map Page or compass bearing arrow on Navigation Page.
8. At destination, Arrival Alarm goes off; to clear it, press **EXIT**. Cancel navigation: press **MENU** | **MENU** | ↓ to **CANCEL NAVIGATION** | **ENT** | ← to **YES** | **ENT**.
9. Return to Wpt 1 by Navigate To Waypoint or Backtrack Trail. **To Waypoint**: press **WPT** | → to **SAVED** | **ENT** | **ENT** | **ENT**. Use ↑ or ↓ to select *Wpt 001*, press **ENT** | **ENT**; follow navigation displays. **Trail**: press **MENU** | **MENU** | ↓ to **MY TRAILS** | **ENT**. Press ↓ to *Trail 1* | **ENT** | → | ↓ to **NAVIGATE** | **ENT** | ↓ to **NAVIGATE** | **ENT** | → to **REVERSE** | **ENT** | ← to **NAVIGATE** | **ENT**. (If arrival alarm sounds, press **EXIT**.) Follow navigation displays.
10. Back home, Arrival Alarm goes off; press **EXIT**. Cancel navigation: press **MENU** | **MENU** | ↓ to **CANCEL NAVIGATION** | **ENT** | ← to **YES** | **ENT**.
11. To turn off the unit, press and hold **PWR** key for three seconds.

## Find Your Current Position

Finding your current position is as simple as turning on the unit. Without obstruction from dense foliage, terrain or structures, the unit automatically searches for satellites and calculates its position in approximately one minute or less.

If for some reason satellite acquisition takes longer, you may be inside a structure or vehicle or in terrain that is blocking signal reception. To correct this, be sure you are positioned so that the unit's antenna module has as clear a view of the sky as possible, then turn the unit off and back on again.

## Moving Around the Map: Zoom & Cursor Arrow Keys

The map is presented from a bird's eye view. The current zoom range shows in the lower left corner of the screen.

1. Press the **ZIN** key (zoom in) to move in closer and see greater detail in a smaller geographic area.
2. Press the **ZOUT** key (zoom out) to move farther away and see less map detail, but a larger geographic area.

When you are traveling, the map will automatically move as you move. This keeps your current location roughly centered on the screen.

You can manually pan or scroll the map northward, southward, eastward or westward by using the arrow keys, which launch the crosshairs map cursor. This allows you to look at map places other than your current position. To clear the cursor, press **EXIT**, which move the map back to the current position or the last known position.

### *Tip:*

Use the cursor to determine the distance from your current position (or last known position, when working indoors) to any map object or location. Simply use the arrow keys to position the cursor over the object or place. The distance, measured in a straight line, appears in the popup data box. Press **EXIT** to clear the cursor.



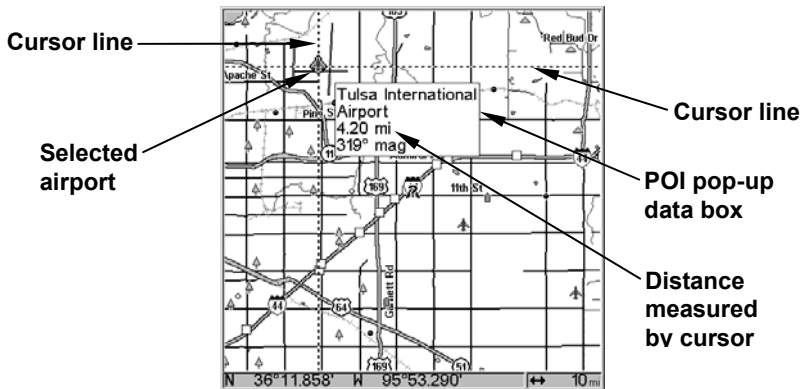

The selected airport to the northwest is 4.2 miles away.

## Selecting Any Map Item with the Cursor

1. Use the zoom keys and the arrow keys to move around the map and find the item you wish to select.
2. Use the arrow keys and center the cursor crosshairs on the desired object. On most items, a pop-up box will give the name of the selected item.

### Tip:

This unit has a Cursor Undo feature that lets you instantly return to the previous location you were looking at without scrolling. It works like this: Use the cursor (arrow keys) to scroll the map to some far away location or waypoint. Press **EXIT** to clear the cursor and jump back to your current position on the map. When you want to take another peek at that distant place, just press **EXIT** again. You can use this trick to toggle between your current position and your destination without a lot of scrolling.

## Searching

Now that you have seen how the unit can find where *you* are, let's search for something else. Searching is one of the most powerful features in the Lowrance GPS product line. In this example, we will look for the *nearest* fast-food restaurant. For more information on different types of searches, refer to *Sec. 9, Searching*.

### NOTE:

This example requires the Point of Interest (POI) database included with a high detail MapCreate 6 custom map.

**After the unit has acquired a position:**

1. Press **WPT** |  $\downarrow$  to **POI-RESTAURANTS**.
2. You could search the entire restaurant category, but in this example we will narrow our search. Press  $\rightarrow$  to **SUBCATEGORY** column |  $\downarrow$  to **FAST FOOD CHAINS** | **ENT** |  $\downarrow$  to **NEAREST** | **ENT**.
3. The unit says it is calculating, then a list of restaurants appears, with the closest highlighted at the top of the list. The restaurant farthest from you is at the bottom of the list.



Find Waypoint Menu (left). Category Selection menu (center). List of the nearest restaurants (right).

4. You could scroll through the list to select another restaurant, but for now we will just accept the nearest one. Press **ENT**.

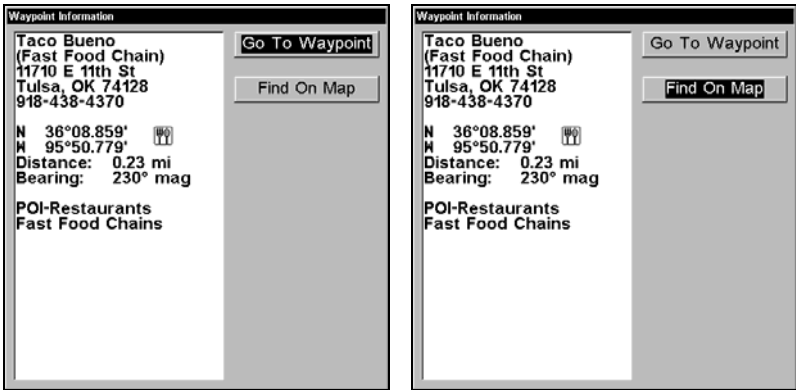

The POI Information screen shows name, street address, phone number, latitude/longitude, distance to restaurant and its compass bearing. In the first figure (left) Go to Waypoint is selected. In the second figure (right) Find on Map is highlighted.

5. The POI information screen appears. If you wanted to navigate there, you could press Enter, since the Go To Waypoint command is highlighted. We just want to see it on the map, so press  $\downarrow$  to **FIND ON MAP** | **ENT**.

6. The unit's map appears, with the cursor crosshairss highlighting the restaurant's POI symbol. A pop-up data box shows the POI's name, distance and bearing. A data box at the bottom of the screen continues to display the location's latitude and longitude.

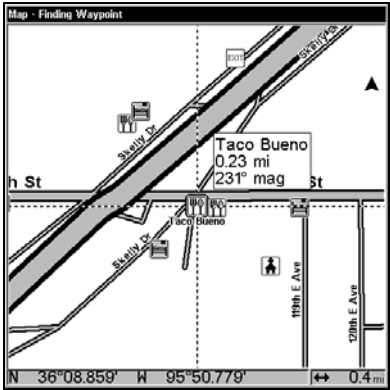

**Map screen showing Finding Waypoint, the result of a restaurant search.**

7. To clear the search and return to the last page displayed, press **EXIT** repeatedly. (Before you completely exited out of the Search menus, you could have gone looking for another place.)

**NOTE:**

Search works from mapping and POI data loaded in the unit. If you do not have a high-detailed custom map (containing POI data) for the area you are searching loaded on the MMC, you may not find anything.

**Set a Waypoint**

A waypoint is simply an electronic address, based on the latitude and longitude of a position on the earth. A waypoint represents a location or destination that can be stored in memory, then recalled later for navigational use.

You can create a waypoint at the cursor position on the map or at your current position while you are navigating. A waypoint may be created at any location by manually entering the position's latitude and longitude. You can copy waypoints from your unit to your personal computer with MapCreate software. When you want to repeat a trip, these archived waypoints can be reloaded into your GPS unit.

**To create and save a Waypoint:**

These first two techniques use the Quick Save method, the fastest and easiest way to create a waypoint.

### Create Waypoint at Current Position

While you are traveling, press **WPT** | **WPT**. The waypoint is saved and automatically given a name with a sequential number, such as "waypoint 003." The waypoint symbol and number appear on the map.

Step 1.

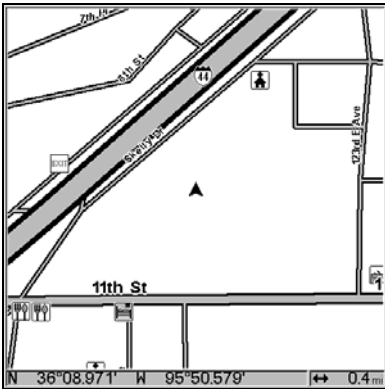

Step 2.

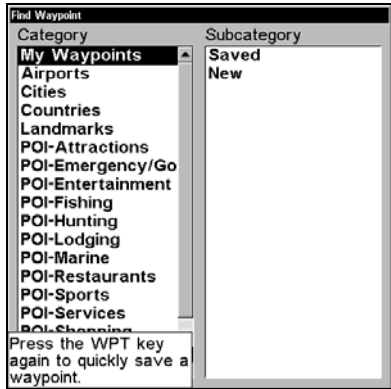

Step 3.



Step 4.

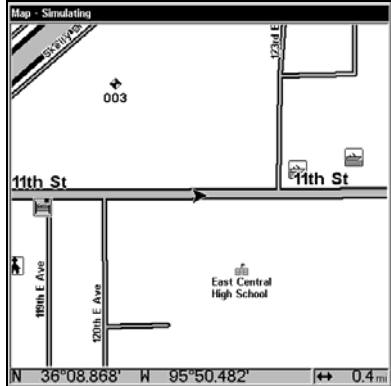

Sequence for setting a waypoint. Step 1: while traveling, press **WPT** twice to call up the Find Waypoint screen (seen in Step 2) and set a waypoint. Step 3: a message says the waypoint has been saved. Step 4: vehicle continues on its way; waypoint number and symbol are visible on map.

### NOTE:

The Quick Save method uses the default waypoint symbol until you edit an existing waypoint and change its symbol. After a waypoint symbol is changed, the unit will remember the one you chose and use it the next time you save a waypoint. To go back to the default symbol, edit a waypoint and choose the original symbol, or use the Reset Options command.

### Create Waypoint on Map

1. Use the arrow keys to move the cursor crosshairs to the place where you want to make a waypoint.
2. Press **WPT|WPT**. The waypoint is saved and automatically given a name with a sequential number, like "waypoint 001." The waypoint symbol and number appear on the map.

### Navigate To a Waypoint

You can select any waypoint visible on the Map Page with the cursor, then use the Navigate to Cursor command (we'll describe how later in this section.) However, you can avoid scrolling the map to pick your waypoint if you use the Find Waypoint commands:

1. Press **WPT|→** to **SAVED|ENT**. To look up the nearest waypoint, press **↓** to **NEAREST|ENT**; or, to look by name (and scroll through the entire waypoint list), press **ENT**. For this example, let's look by name.
2. If your waypoint list is a long one, you can spell out the waypoint name in the **FIND BY NAME** box to search for it. (Press **↑** or **↓** to change the first character, then press **→** to move the cursor to the next character and repeat until the name is correct, then press **ENT** to jump to the list below.)
3. If the list is short, you can jump directly to the **FIND IN LIST** box by pressing **ENT**. Use **↑** or **↓** to select the waypoint name, press **ENT** and the waypoint information screen appears with the **Go To** command selected.
4. To begin navigating to the waypoint, press **ENT**.

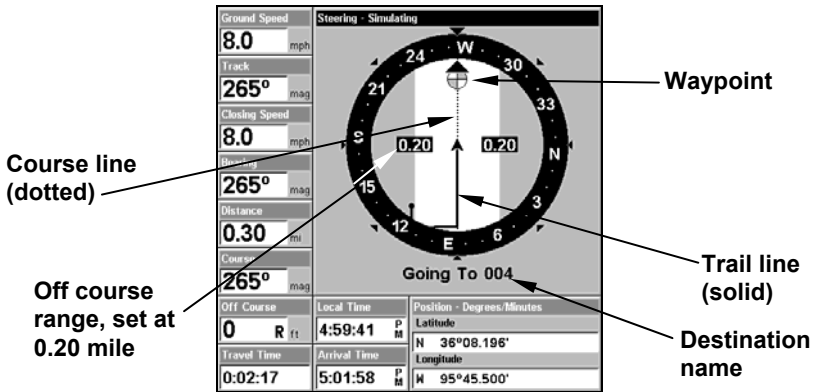

Navigation Page, navigating toward waypoint 004 and leaving a trail.

### Set Man Overboard (MOB) Waypoint

One of boating's most terrifying events is having a friend or family member fall overboard. This situation can be deadly on any body of water. It's particularly dangerous at night or if you're out of sight of land.

Of course, the first thing to do is remain calm and then use all standard safety procedures to rescue the person.

This unit has a man overboard feature that shows navigation data to the location where the feature was activated. To activate it, press the **ZOUT** and **ZIN** keys at the same time. Your position at the time these keys are pressed is used as the man overboard position.

**Caution:**

*Saving a new "Man Overboard" waypoint will overwrite the previous "Man Overboard" waypoint.*

**Navigate Back to MOB Waypoint**

Find your way back to the accident position with the Navigation Page or Map Page. When MOB is activated, the Navigation Page automatically shows the compass rose with its bearing arrow pointing toward the man overboard position, and the destination name says "Going To Man Overboard." The Map Page displays a Man Overboard waypoint, represented by a human figure, and the steering arrow points where to steer to reach that position.



**Navigating to Man Overboard: Man Overboard Activated message (left). Navigation Page, center, Map Page (right). The victim is to the starboard of the vessel. The GPS shows which direction to go for the rescue.**

The man overboard position is also stored in the waypoint list for future reference. It can be edited the same as any other waypoint. This prevents the inadvertent loss of the current Man Overboard position.

To cancel navigation to MOB, press **MENU|MENU|↓** to **CANCEL NAVIGATION|ENT|←** to **YES|ENT**. The unit stops showing navigation information.

**Navigate to Cursor Position on Map**

The **GO TO CURSOR** command: navigates to the current cursor position on the map. It's a quick and handy way to navigate to anything you can see on the map display.

1. Use the cursor (controlled by the arrow keys) with the zoom in and zoom out keys to maneuver around the map until you find a location you want to go to.

2. Center the cursor over the location to select it. See the example in the following figure. (Many map items such as waypoints, Points of Interest, towns, etc. can be "selected," and appear "highlighted" with a pop-up box. Other features, such as a river or a street intersection will not appear "highlighted," but the cursor will take you to those locations just the same.)



**Navigate to cursor. In this example, the cursor is centered on Oologah, Oklahoma.**

3. Press **MENU|ENT** and the unit will begin navigating to the cursor location.

The Map Page will display a dotted line from your current position to the cursor position. The Navigation Page displays a compass rose showing navigation information to your destination. See the following examples.



The 15-mile zoom figure (left) clearly shows the dotted course line connecting your current position to your destination. The 40-mile zoom (center) shows both current position and destination on screen. The Navigation Page (right) will also show navigation information.

To stop navigating to the cursor, use the Cancel Navigation command: press **MENU | MENU | ↓** to **CANCEL NAVIGATION | ENT | ←** to **Yes | ENT**. The unit stops showing navigation information.

## Navigate to a Point of Interest

For POIs that are in view on the map, you can easily use the Navigate to Cursor command above; just use the cursor to select the POI.

The other method involves searching for POIs with the Find Waypoint command, launched with the **WPT** key. (See the searching example earlier in this section, or turn to Sec. 9, *Searching*, for detailed instructions on POI searches.)

To Navigate to a POI:

1. Press **WPT**, select the desired POI category, then press **→** to Subcategory.
2. Highlight the desired subcategory and press **ENT**. The Find By menu will appear with two search options: Name of Nearest.
3. Select the desired search option and press **ENT**. A list of POIs will appear. If you chose Nearest as the search option, use **↑ ↓** to select the desired POI and press **ENT**. If you chose to search by Name, use **↑ ↓, ← →** to input the POI name. When the name has been entered press **ENT** to access the POI list.
4. Select the desired POI and press **ENT**, which will open the Waypoint Information menu.
5. Highlight **Go To WAYPOINT** and press **ENT**. The unit begins showing navigation information to the item.

To cancel navigation, press **MENU | MENU | ↓** to **CANCEL NAVIGATION | ENT | ←** to **Yes | ENT**. The unit stops showing navigation information.

## Creating and Saving a Trail

A trail, or plot trail, is a string of position points plotted by the unit as you travel. It's a travel history, a record of the path you have taken. Trails are useful for repeating a journey along the same track. They are particularly handy when you are trying to retrace your trip and go back the way you came. On the screen, trails are represented by a solid line extending from the back of the current position arrow.

The unit is set at the factory to automatically create and record a trail while the unit is turned on. The unit will continue recording the trail until the length reaches the maximum trail point setting (default is 2,000, but the unit can record trails 9,999 points long). When the point limit is reached, the unit begins recording the trail over itself.



By default, the trail flashes once a second, making it easier to see against the background map. With the default auto setting, this unit creates a trail by placing a dot (trail point) on the screen every time you change directions. (The methods used for creating a trail and the trail update rate can both be adjusted or even turned off. See Sec. 8 for *Trail Options*.)

To preserve a trail from point A to point B, you must "turn off" the trail by making it *inactive* before heading to point C or even back to point A. When the current trail is set inactive, the unit *automatically* begins recording a new trail.

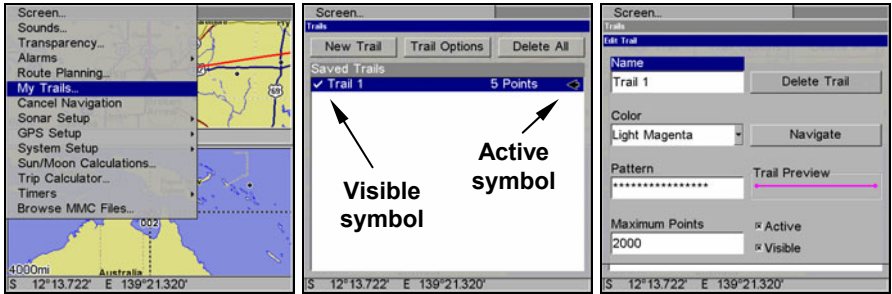

Sequence for saving a trail and beginning a new one. Left, My Trails command. Center, the Trails Menu. The arrow to the right of Trail 1 indicates the trail is "active," and the check to the left indicates the trail is visible on the map display. The right figure shows the Edit Trail menu, with the Active command selected.

**To Save a Trail**

1. Press **MENU | MENU | ↓** to **MY TRAILS | ENT**.
2. Press **↓** to the *Active Trail Name* | **ENT**.
3. Press **↓** to **ACTIVE | ENT**. This unchecks the Active option.
4. To return to the previous page, press **EXIT** repeatedly. As you leave the Edit Trail menu, you will notice that a new trail starts with a new sequential number. In the example figure below, the new trail is number 2, showing zero points. Note that Trail 1 is inactive, but it is still visible on the map.

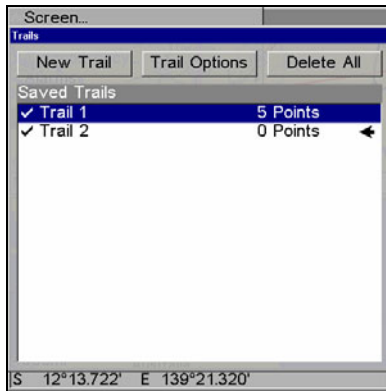

New trail, named "Trail 2," is created when Trail 1 is made inactive. Any new travel will be recorded in this trail, which is active and visible. Trails do not need to be visible in order to be active.

You can save and recall up to 10 different plot trails, which can be copied to your MMC for archiving or for transfer to your MapCreate software.

**Tip:**

Another quick way to stop recording one trail and begin a new one is to use the New Trail command: Press **MENU|MENU|↓** to **MY TRAILS|ENT|ENT**.

**Caution:**

*You also have the option of completely turning off trail recording, under the trail Options command. However, if the Update Active Trail option is turned off, it will cancel the automatic trail creation feature.*

## Displaying a Saved Trail

The active trail is automatically displayed on the map (the "Visible" option) with the factory default settings. You can selectively turn trail display off and on for any saved or active trail. In the Saved Trails List, visible trails have a check mark in front of the trail name.

**To turn off trail display:**

1. Press **MENU|MENU|↓** to **MY TRAILS|ENT**.
2. Press **↓** to enter the Saved Trail list, then use **↑ ↓** to select the desired *Trail Name|ENT*.
3. Press **↓** to **ACTIVE|→** to **VISIBLE|ENT**. To return to the previous page, press **EXIT** repeatedly.

### To turn on trail display:

1. Press **MENU | MENU | ↓** to **MY TRAILS | ENT**.
2. Press **↓** to enter the Saved Trail list, then use **↑ ↓** to select the desired *Trail Name* | **ENT**.
3. Press **↓** to **ACTIVE | →** to **VISIBLE | ENT**. To return to the previous page, press **EXIT** repeatedly.

## Navigating Trails

There are three methods for following a trail: visual trailing, navigating a trail (forward) and backtracking a trail (backward). Try each method to see which you prefer.

Visual trailing is the simplest method. It uses only the Map Page and requires no menu commands at all. The technique works the same if you are running a trail forward (from start to end) or backward (from end to start.) However, visual trailing provides no navigation information during the trip, such as the time to your destination.

The other two methods provide a full range of navigation data and work with both the Map Page and Navigation Page. The only difference between them is "navigating a trail" follows a trail forward (from start to end) while "backtracking" follows a trail in reverse (from end to start.)

When hiking at walking speed with a hand-held GPS, we often just use visual back trailing because it is a bit better at following each little turn on a foot path. At faster speeds, such as the highway or on the water, the Navigate Trail and Backtrack Trail commands are handy.

### Visual Trailing

1. On the Map Page, zoom (**ZIN** or **ZOUT**) so your flashing trail is visible.
2. Begin moving and watch the Map Page. Simply walk or steer so that your current position arrow traces along the trail you have just made.

#### *Tip:*

Generally, when using this method, the smaller the zoom range, the more accurately you will be able to steer along the trail.

### Navigate a Trail

The following figures illustrate the menu sequence for navigating a trail.

1. Press **MENU | MENU | ↓** to **MY TRAILS | ENT**.
2. Press **↓ | ↓** to enter the Saved Trail list, then use **↑** or **↓** to select the desired *Trail Name* | **ENT**.

3. Press → to **DELETE TRAIL** | ↓ to **NAVIGATE** | **ENT**.
4. Press ↓ to **NAVIGATE** | **ENT**. The unit begins showing navigation information along the trail.

**NOTE:**

If you are already located at or near the beginning of your trail, the arrival alarm will go off as soon as you hit Enter. Press **EXIT** to clear the alarm and proceed.

5. Now, begin navigating with your unit.
6. When you reach your destination, be sure to cancel your navigation: press **MENU** | **MENU** | ↓ to **CANCEL NAVIGATION** | **ENT**. The unit asks if you're sure; press ← | **ENT**

**Figure 1.**



**Figure 3.**

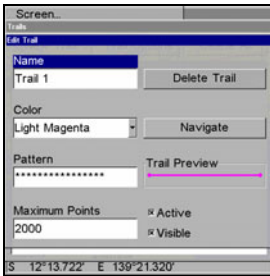

**Figure 2.**

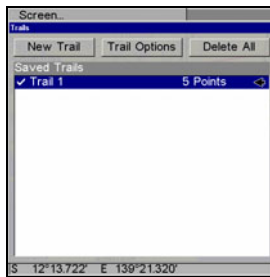

**Figure 4.**

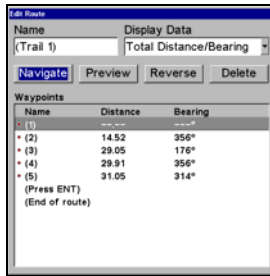

**Navigate a trail menu sequence: Fig. 1, My Trails command. Fig. 2, Trails Menu. Fig. 3, Edit Trail Menu. Fig. 4, Edit Route Menu with Navigate command highlighted for Trail 6. A trail is always converted to a "route" when you navigate the trail.**

On the Map Page, the trail you are navigating is represented by a dotted line that alternates with a flashing solid line. The Navigation Page will also show the navigated trail as a dotted line. The bearing arrow on the compass rose points to the next waypoint on the trail.

As you travel, the arrival alarm will go off when you near a trail waypoint, and the bearing arrow on the compass rose will swing around and point to the next trail waypoint. Press **EXIT** to clear the alarm.

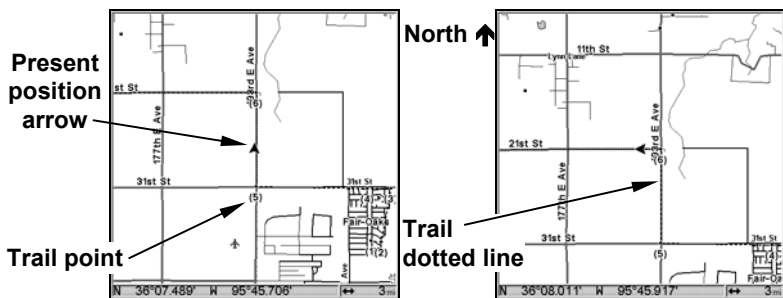

Navigate trail, map views: Driver is northbound heading straight toward trail point 6 (left). Northbound driver has reached point 6 and has turned west to follow trail (right).

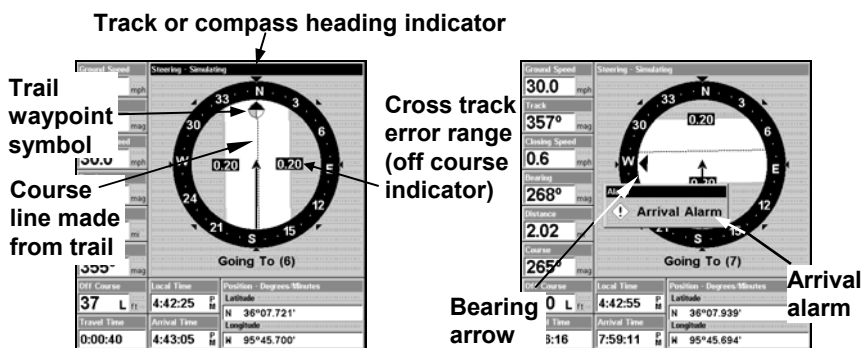

Navigate trail, navigation page (compass rose) views: driver is northbound heading straight toward trail point 6 (left); bearing arrow shows the trail point is due north (straight ahead.) Driver has reached trail point 6 and must turn west to follow the trail (right). Arrival alarm goes off and bearing arrow swings around toward the west and the next waypoint. The unit now shows navigation information to point 7, which is 2.02 miles away.

### Navigate a Back Trail (backtrack)

1. Press **MENU | MENU | ↓** to **MY TRAILS | ENT.**
2. Press **↓ | ↓** to enter the Saved Trail list, then use **↑** or **↓** to select the desired *Trail Name* | **ENT.**
3. Press **→** to **DELETE TRAIL | ↓** to **NAVIGATE | ENT.**
4. Press **↓** to **NAVIGATE | →** to **REVERSE | ENT | ←** to **NAVIGATE | ENT.** The unit begins showing navigation information along the trail, in reverse.

## NOTE

If you are already located at or near the end of your trail, the arrival alarm will go off as soon as you hit **ENT**. Press **EXIT** to clear the alarm and proceed.

5. Now, begin navigating with your unit.

6. When you reach your destination, be sure to cancel your navigation: press **MENU | MENU | ↓** to **CANCEL NAVIGATION | ENT**. The unit asks if you're sure; press **← | ENT**.

## Transfer Custom Maps and GPS Data Files

### Custom Maps:

Custom maps work only from the MMC card or SD card. When a card containing a Custom Map File is loaded into the unit, the unit automatically loads the map into memory when the unit is turned on.

Instructions for copying Custom Map Files to an MMC are contained in the instruction manual for your MMC card reader and MapCreate 6 software. For instructions on inserting an MMC into the unit, *see Sec. 2, Installation/Accessories*.

### GPS Data files:

GPS Data Files contain waypoints, routes, trails and event marker icons. Instructions for copying GPS Data Files between your computer and an MMC are contained in the instruction manual for your MMC card reader and MapCreate 6 software.

GPS data automatically recorded in the unit's internal memory must be saved to the MMC (as a GPS Data File) in order to store it on your personal computer. GPS Data Files stored on an MMC must be copied from the card to the unit's internal memory before the unit can read them. Here's how:

1. Insert the MMC into your unit. Press **MENU | MENU | ↓** to **SYSTEM SETUP | ENT | ↓** to **TRANSFER MY DATA | ENT** and the screen below appears.

2. The Transfer My Data menu includes a message which tells you if an MMC is present or not. If no MMC is present, you must first insert a card into the unit in order to activate the Load or Save commands.

To transfer data *from the unit to the MMC*: press **ENT** (for **SAVE**.)

To transfer data *from the MMC to the unit*: press **→** to **LOAD | ENT**.

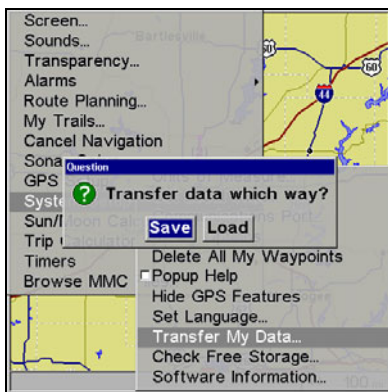
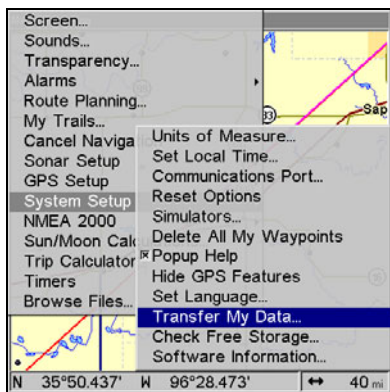

**Transfer My Data highlighted (left). When transferring data (right) you will have the option of transferring the unit's data to a MMC card or loading the data on the MMC card into the unit.**

3. **Saving to MMC:** To accept the default name "Data" for the GPS Data File, press **↓** to **SAVE DATA** | **ENT**. If you want to rename the file (as shown in the following figures), press **ENT** to activate the selection box. Press **↑** or **↓** to change the first character, then press **→** to the next character and repeat until the name is correct. Then, press **ENT** | **↓** to **SAVE DATA** | **ENT**.

The unit will display first a progress message followed by a completion message when the data transfer is finished. To return to the Page view, repeatedly press **EXIT**.

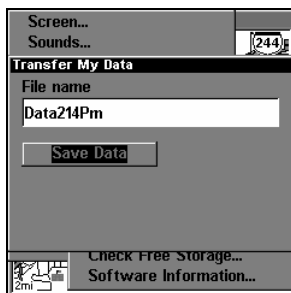
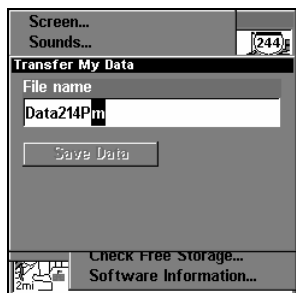
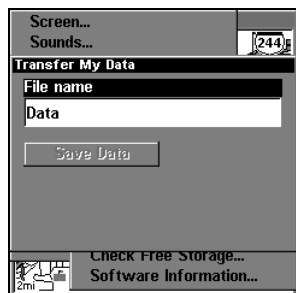

**These figures (left to right) show the menu sequence for naming and saving a GPS Data File from the unit's memory to an MMC.**

4. **Loading to unit memory:** There may be more than one GPS Data File (\*.USR) on the card. To select a file, press **ENT** to activate the selection box, use **↓** or **↑** to highlight the file, then press **ENT** to accept the selection. Next, press **↓** to **LOAD DATA** | **ENT**. The unit will display a completion message when the data transfer is finished. To return to the Page view, press **EXIT** repeatedly.

Figure 1.

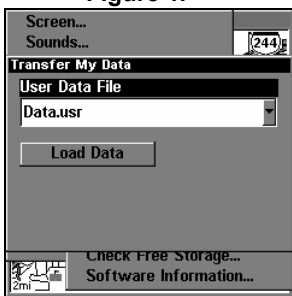

Figure 2.

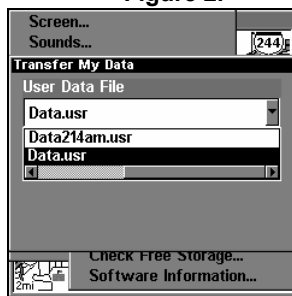

Figure 3.

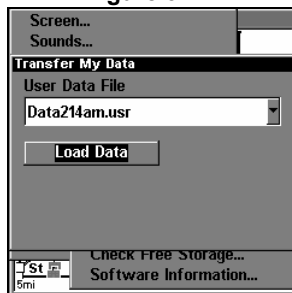

Figure 4.



These figures show the menu sequence for loading a GPS Data File from an MMC into the unit's memory.

## Cancel Navigation

You can turn off any of the navigation commands after you reach your destination or at any other time by using the Cancel Navigation command. Press **MENU | MENU | ↓** to **CANCEL NAVIGATION | ENT | ←** to **Yes | ENT**.



# Section 7:

## Advanced GPS Operations

### Find Distance from different Locations

1. While on the Map Page press: **MENU** | ↓ to **FIND DISTANCE** | **ENT**.
2. Center your cursor over the position you want to find the distance to. A rubber band line appears, connecting your current position to the cursor's location. The distance along that line will appear in a pop-up box. The box also shows the bearing to the point you're measuring to.
3. Press **EXIT** to return to regular operation.

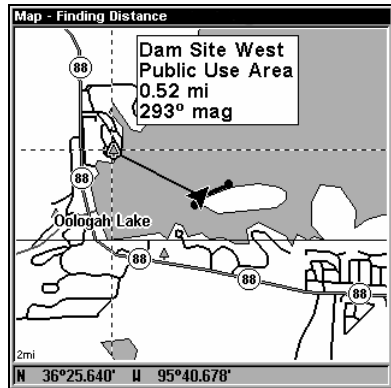
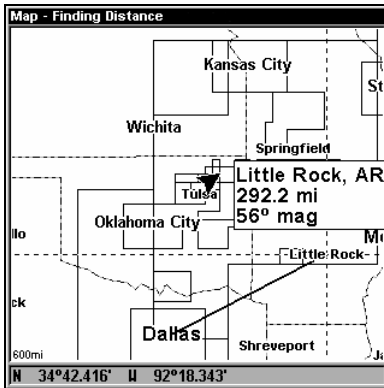

Distance from Dallas to Little Rock is 292.2 miles (left). The distance from the boat's current position to the boat ramp is 0.52 miles (right).

### Find Distance from Point to Point

You can also measure distance between two other points on the map.

1. While on the Map Page press: **MENU** | ↓ to **FIND DISTANCE** | **ENT**.
2. Center your cursor over the first position. (A rubber band line appears, connecting your *current* position to the cursor's location.) Press **ENT** to set the first point, and the rubber band line disappears.
3. Move the cursor to the second position. The rubber band line reappears, connecting the first point you set to the cursor. The distance along that line will appear in the pop-up box.
4. Press **EXIT** to clear the command and return to the page screen. (Press **EXIT** once more to clear the cursor.)

# Icons

Icons are graphic symbols used to mark some location, personal point of interest or event. They can be placed on the map screen, saved and recalled later for navigation purposes. These are sometimes referred to as event marker icons. This unit has 42 different symbols you can pick from when creating an icon.

Icons are similar to waypoints, but they do not store as much information (like names) as waypoints do. You can't use a menu to navigate to icons as you can with waypoints. (But, you *can* use the map cursor and navigate to any icon on the map.)

You can create an icon at the cursor position on the map, or at your current position while you are navigating.

## Create Icon on Map

1. Use the arrow keys to move the cursor to the place where you want to make an icon.
2. Press **ENT** and the Select Icon Symbol menu will appear.
3. Press  $\uparrow \downarrow$ ,  $\leftarrow \rightarrow$  to select your icon symbol and press **ENT**. The icon appears on the map.

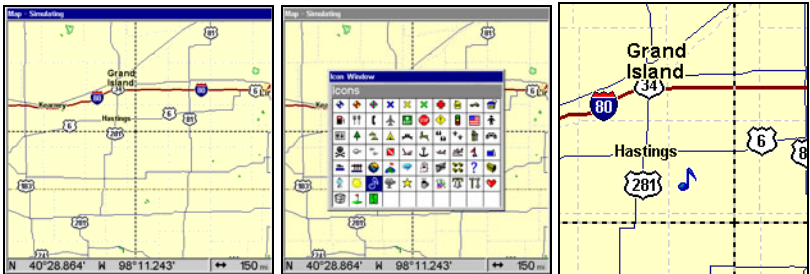

**Cursor selects icon location (left). Select Icon Symbol menu (center), Music note icon on map (right). (Cursor has been moved for clarity.)**

## Create Icon at Current Position

1. While you are traveling, press **ENT** and the Select Icon Symbol menu will appear.
2. Press  $\uparrow \downarrow$ ,  $\leftarrow \rightarrow$  to select your icon symbol, then press **ENT**. The icon appears on the map.

## Delete an Icon

You can delete all the icons at one time, delete all icons represented by a particular symbol or use the cursor to delete a selected icon from the map.

1. Press **MENU** | ↓ to **DELETE MY ICONS** | **ENT**.
2. Press ↓ to **DELETE ALL ICONS**, **DELETE BY SYMBOL**, or **DELETE FROM MAP** and press **ENT**.



**Delete icons menu.**

The Delete All Icons command will ask if you are sure. Press ← to **YES** | **ENT**. All icons will be deleted from the map.

The Delete by Symbol command will launch the Select Symbol menu. Press ← or ↑ or → or ↓ to select the icon symbol to delete, then press **ENT**. A message appears saying all icons with the selected symbol have been deleted.

The Delete From Map command will prompt you to move the cursor over an icon to select it. After selecting the icon, press **ENT** and it disappears from the map.

### **Navigate to an Icon**

Use the cursor to select the desired icon on the map, then use the Navigate to Cursor command.

1. Use arrow keys to center cursor crosshairss over the icon.
2. To navigate to the selected icon location: press **MENU** | **ENT** | **EXIT**. Follow course line on the Map Page or the compass bearing arrow on the Navigation Page.

### **Routes**

A route is a series of waypoints, linked together in an ordered sequence to mark a course of travel. You can visualize a route as a string of beads. The beads represent waypoints and the string represents the course of travel connecting waypoint to waypoint.

The course from one waypoint to the next is a leg. Routes are composed of one or more legs. The legs of all GPS routes are based on straight lines between waypoints.

A route provides the automatic capability to navigate through several waypoints without having to reprogram the unit after arriving at each waypoint. Once programmed into the GPS unit, a route provides the option of navigating forward through the route waypoints or in reverse order (you can even begin navigating in the middle of a route!)

### Create and Save a Route

You have the option of creating and editing a route in the unit or you can make a route on your computer with our MapCreate 6 software.

#### PC-created Routes

MapCreate is the easiest method for preparing a route, simply because your PC's larger screen, keyboard and mouse are easier to manipulate than the unit.

To load a MapCreate route into the unit, follow instructions in MapCreate's manual for creating a route and saving it as part of a GPS Data File (file format \*.usr). Copy the GPS Data File to an MMC and insert the MMC in the unit. (See Sec. 2 for instructions on installing MMCs. To load the GPS Data File into the unit's memory, see the entry on *Transfer Custom Maps & GPS Data Files* in Sec. 6, *Basic GPS Operations*.)

#### Routes Created in the Unit

You can create a route by selecting existing waypoints from the waypoint list or you can set a series of route waypoints on the map with cursor arrows and the Enter key. In this example, we'll create a route from the map.

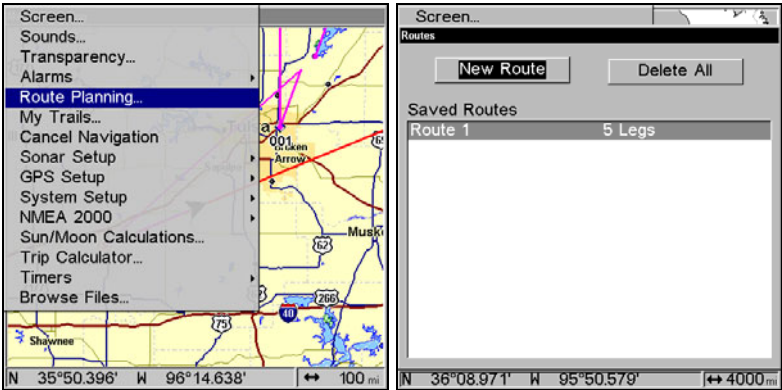

Route Planning command on Main Menu (left). Routes screen (right).

1. From the **NAVIGATION PAGE**, press **MENU | ENT** or from the **MAP PAGE**, press **MENU | MENU | ↓** to **ROUTE PLANNING | ENT | ENT**.
2. Press **↓** to **(END OF ROUTE) | ENT | ↓** to **ADD FROM MAP | ENT**. The Map Page appears with the cursor showing.

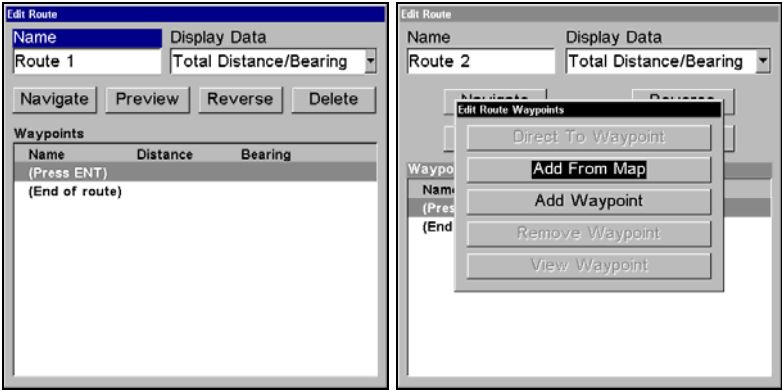

**Edit Route menu (left). Edit Route Waypoints menu (right) with Add From Map command selected.**

3. Use the Zoom keys and arrow keys to move the map and cursor until the cursor is centered on the spot where you want your route to begin. (If you are starting at your current position or the current cursor position, you are already at the starting spot.)

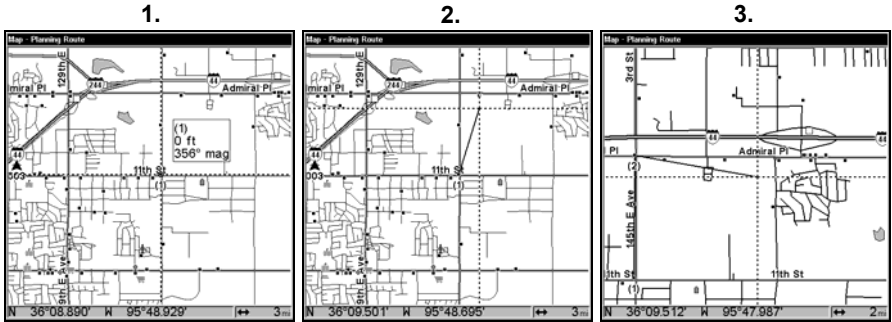

**Route creation sequence, from left: Fig. 1. Set route waypoint (1) at 11th St. & 145th Ave. Fig. 2. Zoom in; move cursor north to set point (2) at 145th & Admiral. Fig. 3. With point (2) set, move cursor east to mark interstate on-ramp with waypoint (3). In figures 2 and 3, notice the rubber band line extending from the previously set waypoint to the cursor. This line will become the course for the route.**

4. Set the first route waypoint: press **ENT**. In this example, we started our route at the intersection of 11th Street and 145th E. Ave. The route ends at a public hunting area next to a river. (Our route creation example is illustrated in the following figures.)

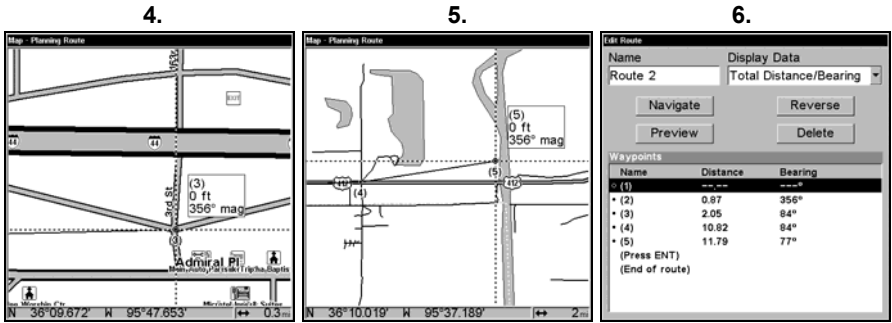

Route creation sequence, continued: Fig. 4. Point (3) set at on-ramp turn. Fig. 5. Waypoint (4) set at highway exit to frontage road leading to river. Waypoint (5) ends the route at a tree stand in the hunting area. Fig. 6. Press **EXIT** to save the route and you return to this screen.

5. Move the cursor to the next point in the route, a spot where you need to turn or change direction, and press **ENT** to set the next waypoint.
6. Repeat step five until the route reaches your destination.
7. To save your route, press **EXIT**. The unit reverts to the Edit Route screen, with the route automatically named "Route 1" and stored in the unit's internal memory. (In our example, Route 1 already existed, so the unit automatically made "Route 2.")

You can edit the route and run other commands, but if you are finished with the route for now, return to the last page displayed by pressing **EXIT** repeatedly.

**Delete a Route**

1. From the **NAVIGATION PAGE**, press **MENU | ENT** or from the **MAP PAGE** press **MENU | MENU | ↓** to **ROUTE PLANNING | ENT**.
2. Press **↓** to *route name* | **ENT**.
3. Press **↓** to **NAVIGATE | ENT | →** to **DELETE | ENT | ←** to **YES | ENT**.

**Tip:**

You can also delete all routes at once:

1. From the **NAVIGATION PAGE**, press **MENU | ENT** or from the **MAP PAGE** press **MENU | MENU | ↓** to **ROUTE PLANNING | ENT**.
2. Press **→** to **DELETE ALL | ENT | ←** to **YES | ENT**.

## Edit a Route Name

1. From the **NAVIGATION PAGE**, press **MENU | ENT** or from the **MAP PAGE** press **MENU | MENU | ↓** to **ROUTE PLANNING | ENT**.
2. Press **↓** to *route name* | **ENT** | **ENT**.
3. Press **↑** or **↓** to change the first character, then press **→** to move the cursor to the next character and repeat until the name is correct, then press **ENT**. Return to the previous page by pressing **EXIT** repeatedly.

## Edit Route Waypoints

You can edit the route by adding and removing waypoints.

1. From the **NAVIGATION PAGE**, press **MENU | ENT** or from the **MAP PAGE** press **MENU | MENU | ↓** to **ROUTE PLANNING | ENT**.
2. Press **↓** to *route name* | **ENT** | **↓** to **ROUTE WAYPOINTS LIST**. Use **↓ ↑** to select a waypoint and press **ENT**.

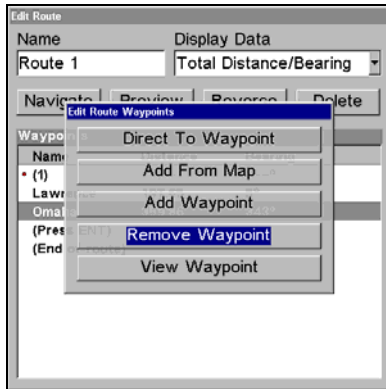

**Edit Route Waypoints menu.**

3. Use **↓ ↑** to select a command from the Edit Route Waypoints menu and press **ENT**. Add From Map lets you insert a waypoint in the route by clicking on a map location with the cursor. Add Waypoint calls up the Waypoint List so you can insert a waypoint from the list. Remove Waypoint will delete the waypoint from the route. View Waypoint will show you where the selected waypoint is on the map.

### NOTE:

When adding waypoints to a route, the inserted waypoints will appear in the route in front of the waypoint you have selected. To insert waypoints at the end of the route, make sure to select "(End of route)" before adding them.

## Navigate a Route

1. From the **NAVIGATION PAGE**, press **MENU|ENT** or from the **MAP PAGE**, press **MENU|MENU|↓** to **ROUTE PLANNING|ENT**.

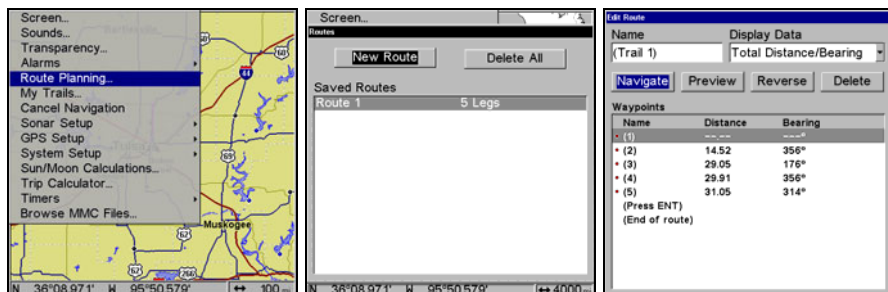

Route Planning on Main Menu (left). Routes menu (center). Edit Route menu (right). Navigate is selected on Edit Route menu.

2. Press **↓** to select *route name* | **ENT** | **↓** to **NAVIGATE|ENT**.

3. Upon arrival at your destination, cancel navigation: press **MENU|MENU|↓** to **CANCEL NAVIGATION|ENT|←** to **YES|ENT**.

The following figures show what the Navigation Page and Map Page look like while navigating a route.

## Navigate a Route in Reverse

Here's how you run a route backward, from the end waypoint to the beginning waypoint:

1. From the **NAVIGATION PAGE**, press **MENU|ENT** or from the **MAP PAGE**, press **MENU|MENU|↓** to **ROUTE PLANNING|ENT**.

2. Press **↓** to select *route name* | **ENT** | **↓** to **NAVIGATE|→** to **REVERSE|ENT|←** to **NAVIGATE|ENT**.

3. Upon arrival at your destination, cancel navigation: press **MENU|MENU|↓** to **CANCEL NAVIGATION|ENT|←** to **YES|ENT**.



Figure 1.

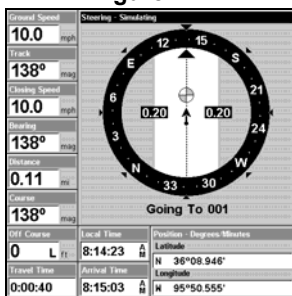

Figure 2.

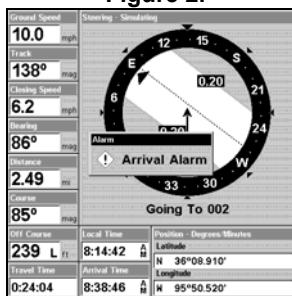
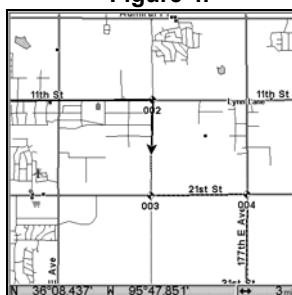

Figure 3.



Figure 4.



Navigating along a route: Fig. 1 shows the Navigation Page at the start of a route, heading straight for the first waypoint (Wpt 1). In Fig. 2, the traveler has arrived at Wpt 1; the arrival alarm has been triggered and the bearing arrow on the compass rose has turned to point toward Wpt 2, off to the east. In Fig. 3 the traveler has turned east on his new course and is heading straight for Wpt 2, which is 2.37 miles away. Fig. 4 shows route navigation on the Map Page. In this figure, the traveler has reached Wpt 2 and is half-way along the leg between Wpts 2 and 3.

## Trails

### Delete a Trail

This is the command used to delete a trail: Press **MENU | MENU | ↓** to **MY TRAILS | ENT | ↓** to *trail name* | **ENT | →** to **DELETE TRAIL | ENT | ←** to **YES | ENT**.

### Tip:

You can also delete all trails at once:

1. Press **MENU | MENU | ↓** to **MY TRAILS | ENT**.
2. Press **→** to **DELETE ALL | ENT | ←** to **YES | ENT**.

### Edit a Trail Name

To edit a trail name: press **MENU** | **MENU** | ↓ to **MY TRAILS** | **ENT** | ↓ to *trail name* | **ENT** | **ENT**. Press ↑ or ↓ to change the first character, then press → to the next character and repeat until the name is correct. Press **ENT** then **EXIT** repeatedly to return to the previous page display.

#### Tip:

You can quickly call up the Edit Trail menu by selecting a trail on the map with the cursor. Simply move the cursor over a trail and a pop-up box appears. Press **WPT** and the Edit Trail menu opens.

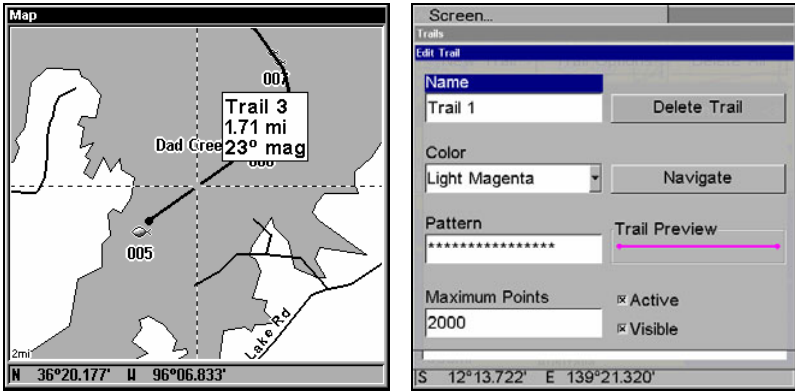

Trail selected with map cursor (left). The pop-up box shows distance and bearing from current position to the selected point on the trail. The Edit Trail menu (right).

### Edit a Trail Color

To edit a trail color: press **MENU** | **MENU** | ↓ to **MY TRAILS** | **ENT** | ↓ to *trail name* | **ENT** | ↓ to **COLOR** | **ENT**. Press ↑ or ↓ to select a color style, then press **ENT**. Press **EXIT** repeatedly to return to the previous page display.

### Edit a Trail Pattern

To edit a trail pattern: press **MENU** | **MENU** | ↓ to **MY TRAILS** | **ENT** | ↓ to *trail name* | **ENT** | ↓ to **PATTERN** | **ENT**. Press ↑ or ↓ to change the first character, then press → to the next character and repeat until the pattern is correct. Press **ENT**, then **EXIT** repeatedly to return to the previous page display.

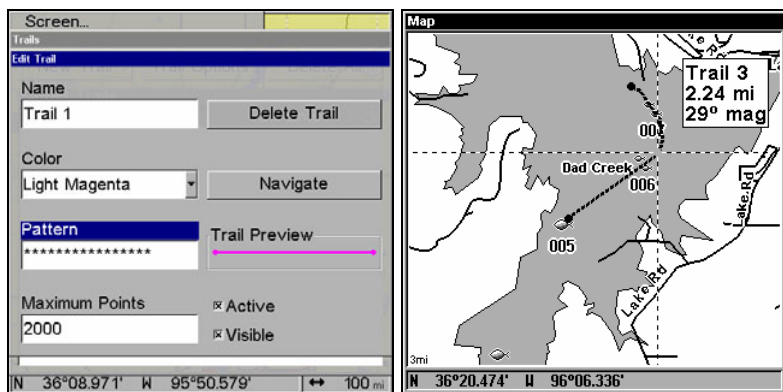

Edit Trail Menu with Pattern option selected (left). Edited trail with dotted line pattern (right).

## Utilities

Utilities are useful tools for traveling or for outdoor activities.

### Alarm Clock

To access the unit's alarm clock: press **MENU | MENU | ↓** to **TIMERS | ENT | ↓** to **ALARM CLOCK | ENT**.

### Sun/Moon Rise & Set Calculator

To get to the Sun/Moon menu: press **MENU | MENU | ↓** to **SUN/MOON CALCULATIONS | ENT**.

### Trip Calculator

To get to the Calculator menu: press **MENU | MENU | ↓** to **TRIP CALCULATOR | ENT**.

### Trip Down Timer

To get to the Down Timer menu: press **MENU | MENU | ↓** to **TIMERS | ENT | ↓** to **DOWN TIMER | ENT**.

### Trip Up Timer

To get to the Up Timer menu: press **MENU | MENU | ↓** to **TIMERS | ENT | ENT**.

## Waypoints

### Delete a Waypoint

To delete a waypoint from waypoint list:

1, Press **WPT | ENT | ENT | ENT | ↓** to *waypoint name* | **ENT | ↓** to **DELETE WAYPOINT | ENT | ←** to **Yes | ENT**. To return to the previous page, press **EXIT | EXIT**.

### To delete a waypoint from the map:

1. Use the arrow keys to select the waypoint with the cursor.
2. Press **WPT** | ↓ to **DELETE WAYPOINT** | **ENT** | ← to **Yes** | **ENT**. To return to the previous page and clear the cursor, press **EXIT**.

### To delete all waypoints at one time:

1. Press **MENU** | **MENU** | ↓ to **SYSTEM SETUP** | **ENT** | ↓ to **DELETE ALL MY WAYPOINTS** | **ENT** | ← to **Yes** | **ENT**. To return to the previous page, press **EXIT** | **EXIT**.

### Edit a Waypoint

#### Waypoint Name

##### To edit waypoint name:

1. Press **WPT** | **ENT** | **ENT** | **ENT** | ↓ to *waypoint name* | **ENT** | ↓ to **EDIT WAYPOINT** | **ENT** | **ENT**.
2. Press ↑ or ↓ to change the first character, then press → to the next character and repeat until the name is correct. Press **ENT** then **EXIT** repeatedly to return to the previous page display.

#### Waypoint Symbol

##### To edit waypoint symbol:

1. Press **WPT** | **ENT** | **ENT** | **ENT** | ↓ to *waypoint name* | **ENT** | ↓ to **EDIT WAYPOINT** | **ENT** | ↓ to **CHOOSE SYMBOL** | **ENT**.
2. Use arrow keys to select desired symbol and press **ENT**. To return to the previous page, press **EXIT** repeatedly.

#### Waypoint Position

##### To edit waypoint position:

1. Press **WPT** | **ENT** | **ENT** | **ENT** | ↓ to *waypoint name* | **ENT** | ↓ to **EDIT WAYPOINT** | **ENT**.
2. Latitude: press → to **LATITUDE** | **ENT**. Press ↑ or ↓ to change the first character, then press → to the next character and repeat until the latitude is correct. Press **EXIT**.
3. Longitude: press ↓ to **LONGITUDE** | **ENT**. Press ↑ or ↓ to change the first character, then press → to the next character and repeat until the longitude is correct. Press **EXIT**.
4. When latitude and longitude are correct, return to the previous page: press **EXIT** repeatedly.

## Selecting a Waypoint

To select a waypoint on the map (for navigating to, for editing, etc.,) use the arrow keys and center the cursor over the waypoint. A highlighted halo will appear around the waypoint.

### Create Waypoint by Entering a Position

1. Press **WPT** | **→** to **SUBCATEGORY** column | **↓** to **NEW** | **ENT**.
2. Press **↓** to **ENTERED POSITION** | **ENT** | **→** to **CREATE** | **ENT**.
3. Press **→** to **LATITUDE** | **ENT**. Enter the latitude by pressing **↑** or **↓** to change the first character, then press **→** to the next character and repeat until the latitude is correct. Press **ENT**.

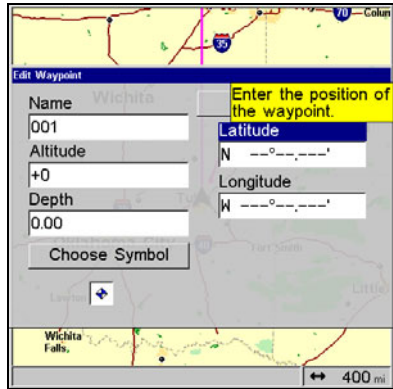
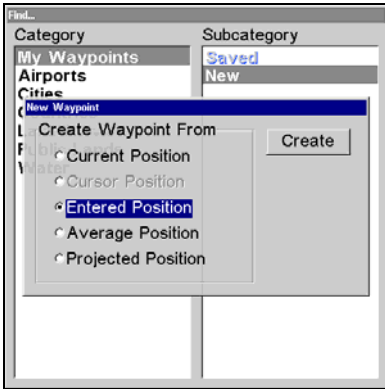

**New Waypoint screen (left). Edit Waypoint menu with Latitude highlighted (right).**

4. Press **↓** to **LONGITUDE** | **ENT**. Enter the longitude by pressing **↑** **↓** to change the first character, then press **→** to the next character and repeat until the longitude is correct. Press **ENT**. To edit the waypoint's name, altitude, depth or symbol, proceed to Step 5. If you want to see the waypoint on the map, press **EXIT**, select **GO TO WAYPOINT** or **FIND ON MAP** and press **ENT**. If you select Go to Waypoint, a route will be automatically be created directing you to the new waypoint. If you choose Find on Map, the map screen will appear with the cursor crosshairss centered on the waypoint you created.
5. You can edit the waypoint's Name, Altitude or Depth by highlighting the desired category and pressing **ENT**. Use **↑** **↓** to change the first character, then press **→** to the next character and repeat until the desired name, altitude or depth has been entered. Press **ENT**.
6. To edit the waypoint's symbol, highlight **CHOOSE SYMBOL** and press **ENT**. The Icon Window will appear with 63 symbols. Select the desired symbol and press **ENT**.

7. Press **EXIT**, which will open the Waypoint Information menu with up to four options: Go To Waypoint, Find on Map, Edit Waypoint and Delete Waypoint. Select the desired option and press **ENT**.

### Set a Waypoint by Average Position

This feature sets a waypoint at the current position after taking several position readings and averaging them. This boosts waypoint position accuracy by helping to eliminate errors caused by atmospheric conditions and other factors.

1. Press **WPT** | → to **SUBCATEGORY** column | ↓ to **NEW** | **ENT**.
2. Press ↓ or ↑ to **AVERAGE POSITION** | **ENT** | press → to **CREATE** | **ENT**.
3. Wait while the unit takes points to average for the position. (The greater the number of points, the greater the accuracy.) When the desired number of points accumulates, press **ENT** to create and save the waypoint.
4. The Edit Waypoint menu appears. You can simply save the waypoint by pressing **EXIT** | **EXIT** or you can edit the waypoint.

### Set a Waypoint by Projecting a Position

This feature sets a waypoint at a point located a specific distance and bearing from a reference position. The reference position can be selected from your waypoint list, a map feature or from the Points of Interest list.

1. Press **WPT** | → to **SUBCATEGORY** column | ↓ to **NEW** | **ENT**.
2. Press ↓ to **PROJECTED POSITION** | **ENT** | → to **CREATE** | **ENT**.
3. Press → to **CHOOSE REFERENCE** | **ENT**. Use ↑ and ↓ to select a waypoint, map feature or Point of Interest. When the point has been selected, press **ENT** and you will be directed to the Waypoint information menu. There will be two options: Set Reference or Find on Map. Highlight Set Reference and press Enter.
4. Press ↓ to **DISTANCE** | **ENT**. Press ↑ or ↓ to change the first character, then press → to the next character and repeat until the distance is correct. Press **ENT**.
5. Press ↓ to **BEARING** | **ENT**. Press ↑ or ↓ to change the first character, then press → to the next character and repeat until the bearing is correct. Press **ENT**.
6. Press ↑ to **PROJECT** | **ENT**. The Edit Waypoint menu appears. You can simply save the new projected waypoint by pressing **EXIT** | **EXIT** or you can edit the waypoint. (Press **EXIT** | **ENT** if you want to immediately begin navigating to the new waypoint.)

# Section 8:

## System & GPS Setup Options

### Alarms

This unit has several GPS alarms. The factory default setting has all of these but the anchor alarm turned on. You can turn the alarms off and on and change their distance settings.

You can set an arrival alarm to flash a warning message and sound a tone when you cross a preset distance from a waypoint. For example, if you have the arrival alarm set to .1 mile, then the alarm will flash a message when you come within .1 mile of the recalled waypoint.

The off course alarm warns you when your track drifts too far to the right or left of the course line to the waypoint. For example, if the alarm is set to .1 mile, then the alarm flashes a message if you drift .1 of a mile or more to the right or left of the line to the waypoint.

The anchor alarm is triggered when you drift outside of a preset radius. Again, using the .1 mile as an example, if you're anchored and your boat moves more than .1 of a mile, the alarm will flash a message and sound a tone.

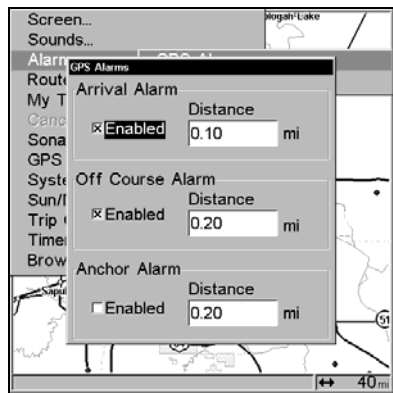
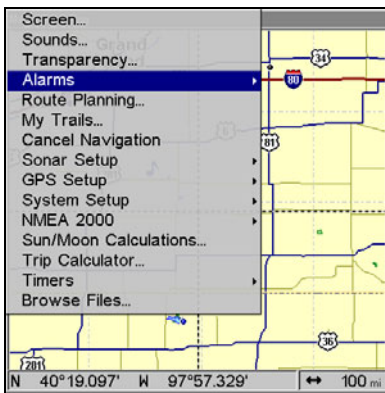

Alarms command (left). Alarm menu (right).

To change alarm settings:

1. Press **MENU** | **MENU** | ↓ to **ALARMS** | **ENT** | **ENT**.
2. Scroll ↓ ↑ to select the desired category, then press **ENT** to check or clear the Enabled box. This turns the alarm on (checked) or off (unchecked.)

3. To change distance settings, scroll ↓ ↑ to select the desired category, then press → | **ENT** to activate the distance dialog box. Use ↑ ↓ to change the first character, then press → to the next character and repeat until the name is correct.
4. When your adjustments are finished, return to the last page displayed by repeatedly pressing **EXIT**.

### **IMPORTANT ALARM NOTES**

Anchor Alarm - The anchor alarm may be triggered even when you are sitting still. This typically happens when using small (less than .05 mile) anchor alarm ranges.

Arrival Alarm - If you set the arrival alarm's distance to a small number and you run a route (see the Navigate Routes segment), this unit may not show navigation data to the next waypoint, once you arrive at the first one. You may not be able to come close enough to the first waypoint to trip the arrival alarm.

### **Auto Satellite Search**

To lock on to the satellites, the GPS receiver needs to know its current position, UTC time and date. (Elevation [altitude] is also used in the equation, but it's rarely required to determine a position.) It needs this data so that it can calculate which satellites should be in view. It then searches for only those satellites.

When your GPS receiver is turned on for the first time, it doesn't know what your position or elevation (altitude) is. It does know the current UTC time and date since these were programmed into it at the factory and an internal clock keeps the time while the unit is turned off. (If the time and/or date are incorrect, you can set them using the "Set Local Time" menu.)

The unit begins searching for the satellites using the above data that it acquired the last time it was turned on. This probably was at the factory. Since it's almost certain that you're not at our factory, it's probably looking for the wrong satellites.

If it doesn't find the satellites it's looking for after approximately one minute, it switches to Auto Search. The receiver looks for any satellite in the sky. Due to advanced technology, the auto search time has shrunk significantly from the early days of GPS.

Once the unit locks on to the satellites, it should take less than a minute to find your position the next time it's turned on, as long as you are approximately 100 miles from the last location it was used.





MMC File Browser.

## Check MMC Files and Storage Space

To check MMC Files:

1. Press **MENU | MENU | ↓** to **BROWSE MMC FILES | ENT**.
2. Use **↑ ↓** to browse through the files. Highlight a file and press **ENT** to select it.
3. Press **EXIT** repeatedly to return to the main display.

## Communications Port Configuration

The unit has one NMEA 0183 version 2.0 compatible communication port, or com port for short. The Com Port Menu, which is accessed from the System Setup Menu, allows you to configure the communications port to send or receive data from another electronic device, such as an autopilot. The com port can be used for either NMEA, or SiRF Binary data transfer.

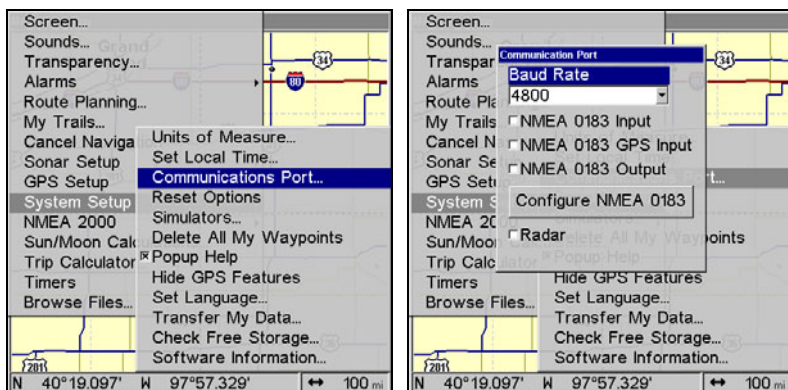

Communications Port highlighted on System Setup menu (left). Baud Rate selected on Communications Port menu (right).

For connectors and wiring information for another device, see page 34. For assistance in configuring the unit to communicate with another device, consult the factory. Customer service phone numbers are in the back of this manual.

## Configure NMEA

You can configure the unit to use specific NMEA sentences.

1. Press **MENU | MENU | ↓** to **SYSTEM SETUP | ENT**.
2. Press **↓** to **COMMUNICATIONS PORT | ENT | ↓** to **CONFIGURE NMEA | ENT**.
3. A menu appears showing the prefixes of the available NMEA sentences. A check mark next to a prefix means the prefix is in use. Use **↑ ↓, ← →** to select a prefix, then press **ENT** to turn off the prefix. (Press **ENT** again to check the box and turn on a prefix.)
4. When the desired prefixes are checked or unchecked, press **EXIT** repeatedly to return to the previous page.

### NOTE:

Placing a check in the checkbox next to Radar at the bottom of the Communications Port menu will set the Baud Rate to the default Radar Baud Rate setting.

## Coordinate System Selection

The Coordinate System Menu lets you select the coordinate system to use when displaying and entering position coordinates.

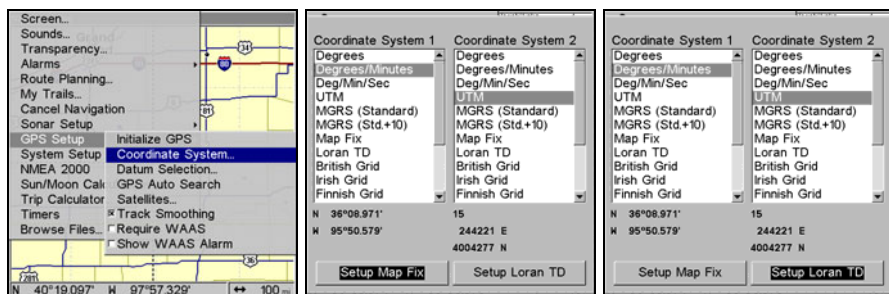

Menus for changing coordinate system used to display positions.

To get to Coordinate System Selection:

1. Press **MENU | MENU | ↓** to **GPS SETUP | ENT**.
2. Press **↓** to **COORDINATE SYSTEM | ENT**.

This unit can show a position in degrees (36.14952°); degrees, minutes and thousandths of a minute (36° 28.700'); or degrees, minutes, seconds and tenths of a second (36° 28' 40.9"). It can also show position in: UTM

(Universal Transverse Mercator) projection; MGRS (Standard); MGRS (Standard + 10); Map Fix; Loran TD; British, Irish, Finnish, German, New Zealand, Swedish, Swiss, Taiwan and Greek.

UTM's are marked on USGS topographic charts. This system divides the Earth into 60 zones, each 6 degrees wide in longitude.

British, Irish, Finnish, German, New Zealand, Swedish, Swiss, Taiwan, and Greek grid systems are the national coordinate system used only in their respective countries. In order to use these grid systems, you must be in the respective country. This unit will pick the matching datum for you when you select the grid. See the entry on Map Datum Selection for more information.

The Military Grid Reference System (MGRS) uses two grid lettering schemes, which are referred to as standard and standard + 10 MGRS on this unit. Your position and datum in use determines which one to use. If you use standard, and your position is off significantly, then try the alternate.

**NOTE:**

When the position format is changed, it affects the way all positions are shown on all screens. This includes waypoints.

To change the coordinate system

1. Press **ENT** while **COORDINATE SYSTEM** is highlighted.
2. Use **↑ ↓** to highlight the desired format and press **ENT**. Press **EXIT** repeatedly to return to the map display.

**To set up Loran TD:**

If the Loran TD conversion is chosen, you must enter the local Loran chain identification for the master and slaves. Highlight **SETUP LORAN TD** at the bottom of the Coordinate System menu and select the ID. Press **EXIT** to close this menu.

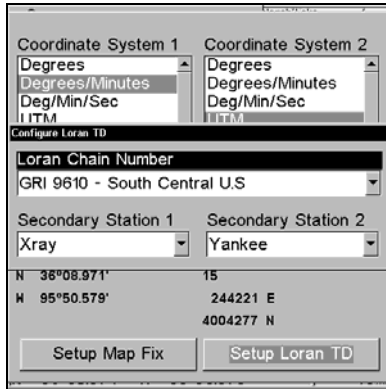

Configure Loran TD menu.

## Map Fix

Map Fix is used with charts or maps. This system asks for a reference position in latitude/longitude, which you take from a marked location on the map. It then shows the present position as distance on the map from that reference point.

For example, if it shows a distance of UP 4.00" and LEFT 0.50", you then measure up four inches and to the left a half-inch from the reference point on the map to find your location.

### To configure a map fix:

To use this format, you need to follow these steps in order. First, take your map of the area and determine a reference latitude/longitude. (Note: in order for this system to work, the latitude/longitude lines must be parallel with the edge of the map. USGS maps are parallel, others may not be. Also, this works better with smaller scale maps, such as 1:24000.) The reference position can be anywhere on the map, but the closer it is to your location, the smaller the numbers will be that you'll have to deal with.

Once you've decided on a reference position, you can save it as a waypoint. See the waypoint section for information on saving a waypoint. Save the reference position as a waypoint. Exit from the waypoint screens.

1. Press **MENU | MENU | ↓** to **GPS SETUP | ENT**.
2. Press **↓** to **COORDINATE SYSTEM | ENT**.
3. Press **↓** to **SETUP MAP FIX | ENT**. The screen below appears, and **MAP SCALE** is highlighted.

4. Press **ENT** and enter the map's scale. This is generally at the bottom of the paper map. It is shown as a ratio, like 1:24000. Press **EXIT** and the unit to return to the Configure Map Fix screen.

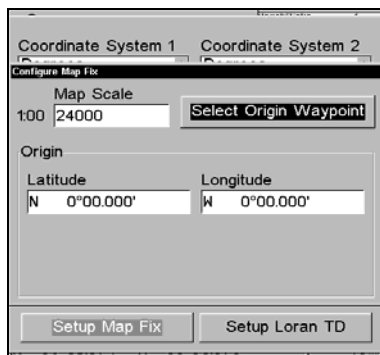

**Configure a map fix so the unit can find your position on a printed chart or topographical map.**

5. Press **→** to **SELECT ORIGIN** | **ENT** | **ENT** | **ENT** to bring up the waypoint list. Select the waypoint that you saved the reference point under and press **ENT**. The unit displays a waypoint information screen with the command **SET AS ORIGIN** selected.

6. Press **ENT** and the unit returns to the Configure Map Fix menu. Finally, press **EXIT** to close this menu.

7. Press **↑** to **COORD SYSTEM** | **ENT**, select **MAP FIX** from the list and press **ENT** | **EXIT**. All position information now shows as a distance from the reference point you chose.

## Customize Page Displays

Every Page display option except Full Map (on the Map Page) has customizable data boxes to provide constant on-screen information.

The data available from your unit is divided into categories in the Data Viewer menu. These categories include GPS Data, Navigation, Trip Calculator, Time, Sonar and Miscellaneous. You can select items from any of these categories for display in any data box — the category divisions are only there to help you sort through the information.

### To change the information displayed in a data box:

1. On the Page display you wish to change, press **MENU** | **↓** to **CUSTOMIZE** | **ENT**. A data box name flashes, indicating it is selected.

2. Press **ENT** to change the box or hit **↑**, **↓**, **←** **→** to select another box, then press **ENT**. You will see a list of categories with "+" or "-" symbols next to each category. A category with a "+" is *expandable*, meaning its contents are hidden.

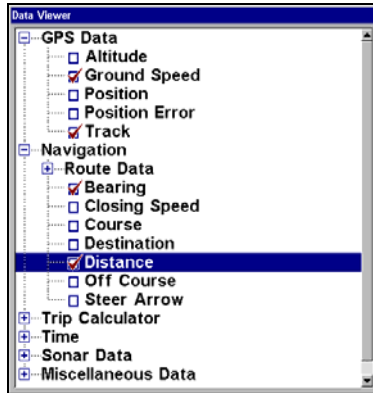

**Customize Menu, with "GPS Data" and "Navigation" categories expanded.**

Selecting the category name and pressing **ENT** will show the category's contents, so you can choose items within it. An expanded category (one with a "-" next to its name) can be collapsed to hide its contents. Just select the category name and press **ENT**.

3. Expand any categories that might contain data you want to display. Press **↓** **↑** to select a different data option.
4. With the new option highlighted, press **ENT** to switch the contents of the box to the new data type and press **EXIT**. You can now select another box to change. When you are finished with the settings, press **EXIT** again to end the Customize command, and the box name stops flashing.

**NOTE:**

A Page display can show a limited number of data boxes. You can not add or remove data boxes.

## GPS Simulator

The GPS simulator lets you use the unit as if you were outdoors navigating somewhere. It's a great way to practice using your unit. You can set the starting location by entering latitude/longitude (Starting Position) or from a stored waypoint, map place or POI. You can steer your position and change speed on the map by using the arrow keys (**STEER WITH ARROWS** command) or by setting the track and speed in the dialog boxes provided on the simulator menu screen.

**To turn on the GPS Simulator:**

1. Press **MENU | MENU**, highlight **SYSTEM SETUP** and press **ENT**.
2. Select **SIMULATORS** and press **ENT**.

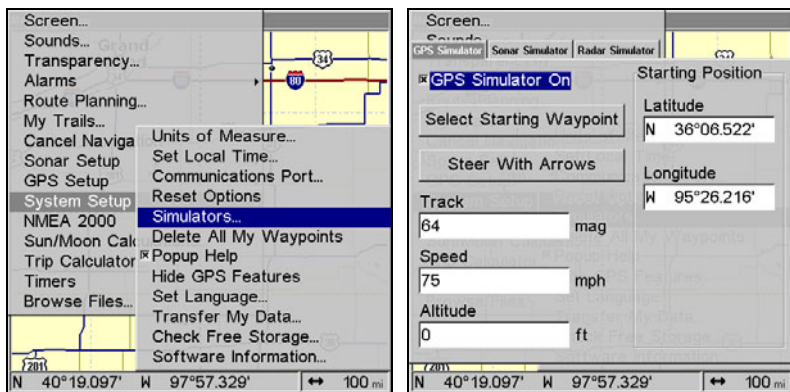

The GPS Simulator menu.

The GPS Simulator page will appear. The page has dialog boxes that allow you to change the Track, Speed, Altitude, Latitude and Longitude of your simulation.

You can begin your simulation at a waypoint by using the Select Starting Waypoint command or direct the simulation manually by using the Steer with Arrows command, which will place Steer with Arrow boxes on the main display.

**Tip:**

The Initialize GPS command offers another way to choose a desired location to begin a simulation. The Initializing GPS command allows you to move the center display arrow to any location on the map. We will explore the Initialize GPS command in more detail in the *Initialize GPS* entry below.

3. When all settings have been set to your preferences, turn on the simulator on by highlighting the **GPS SIMULATOR ON** box and pressing **ENT**. Press **EXIT** repeatedly to return to the map display. Repeat Steps 1-3 to turn off the simulator.

**NOTE:**

A message and tone appear periodically, warning you that the simulator is on. To turn the simulator off, repeat the above steps or turn the unit off.

**Steer with Arrows**

When you are using the Steer with Arrows command, you can press **EXIT** to clear the steering and speed boxes from the screen while continuing the simulation. This action will allow you to use the map cursor during a simulation. To turn steering and speed boxes back on again,

return to the GPS Simulator menu, highlight the **STEER WITH ARROWS** command, press **ENT**. Press **EXIT** repeatedly to return to the previous page.

### **Simulating Trail or Route Navigation**

In Simulator mode, your unit can automatically follow a trail or route without manual steering if you use these steps:

1. From the Map Page, go to the simulator menu. Pick a **STARTING POSITION** at or near the beginning of your trail/route. Enter an approximate **TRACK** (shown in compass degrees) that will point you toward the start of the trail/route.
2. Set **SPEED** to zero. Select **STEER WITH ARROWS** command and press **ENT**, which turns on the simulator and returns you to the Map Page.
3. Begin navigating along the trail/route. (If you are close enough to the first waypoint, the arrival alarm will usually go off as soon as navigation begins. Press **EXIT** to clear the alarm.) When navigation starts, press **↑** to increase speed to the desired setting.
4. Press **EXIT** to turn off the steering and speed boxes. The unit will now automatically steer along the trail or route. Cancel navigation when you arrive at your destination.

### **Hide GPS Feature**

If there is no GPS antenna/receiver module attached to this unit, the GPS menus and features can be hidden from view with this command. The default setting is off, allowing you to rotate between the Sonar Page and the GPS pages and features.

#### **To Hide GPS Features:**

1. Press **MENU | MENU | ↓** to **SYSTEM SETUP | ENT**.
2. Highlight **HIDE GPS FEATURES** and press **ENT**. The GPS menus and pages are now hidden.

To restore GPS Features, press **MENU | MENU | ↓** to **SHOW GPS FEATURES | ENT**. The GPS menus and pages are available once again.

### **Initialize GPS**

This command is handy when you are practicing in simulator mode. (See the entry in this section for *GPS Simulator*.) In simulator mode, this command makes the unit operate as if it is sitting someplace other than its actual location. So, you and your unit could be located in Kansas City, but easily practice navigating in the ocean off Islamorada, Florida.



## To Initialize GPS:

1. Press **MENU | MENU | ↓** to **GPS SETUP | ENT | ENT**.
2. A message appears, prompting you to move the cursor to the desired location. Move the cursor to the desired location and press **ENT**.

When the message automatically clears, follow the message instructions.

3. In a moment, your present position marker arrow appears on the map in the location you selected with the cursor. The unit will consider that spot as its last known position until changed by either a live satellite lock-on or a new simulator location.

## Map Auto Zoom

This unit has an auto zoom feature that eliminates much of the button pushing common with other brands of GPS receivers. It works in conjunction with the navigation features.

First, start navigation to a waypoint. (See the waypoint section for more information on navigating to a waypoint.) Then, with the auto zoom mode on, the unit zooms out until the entire course shows, from the present position to the destination waypoint. As you travel toward the destination, the unit automatically begins zooming in — one zoom range at a time — always keeping the destination on the screen.

To turn on Auto Zoom:

1. From a **MAP PAGE**, press **MENU | ↓** to **AUTO ZOOM | ENT | EXIT**. Repeat these steps to turn it off.

## Map Data

This menu lets you turn the map off, if desired (which turns the map screen into a GPS plotter); turn off or on the pop-up map info boxes; draw the map boundaries or boxes around the areas of high detail; or fill land areas with gray. You can also turn on or off Map Overlays, which display latitude and longitude grid lines or range rings on the map. This menu also lets you select Navionics Maps. For instructions, see the *Navionics Charts* entry in this section.

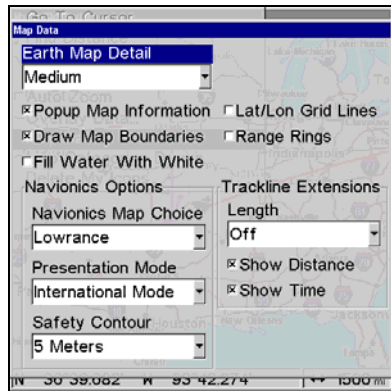
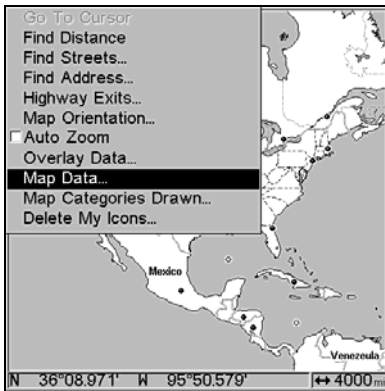

Map Menu (left). Map Data Menu (right).

### To access Map Data menu:

From the Map Page, press **MENU** | ↓ to **MAP DATA** | **ENT**.

### To show Map Data

1. From the Map Page, press **MENU** | ↓ to **MAP DATA** | **ENT**.
2. Press **ENT** to open the **EARTH MAP DETAIL** selection list, and choose how much detail you want — from Off (so the unit operates like a GPS plotter) to High.
3. After the option is set, press **EXIT** repeatedly to return to the page display.

### To turn on/off Pop-up Map Information

1. From the Map Page, press **MENU** | ↓ to **MAP DATA** | **ENT**.
2. Press ↓ to **POPUP MAP INFORMATION**. With the option highlighted, press **ENT** to check it (turn on) or uncheck it (turn off.)
3. After the option is set, press **EXIT** | **EXIT** to return to the page display.

### To turn on/off Draw Map Boundaries

1. From the Map Page, press **MENU** | ↓ to **MAP DATA** | **ENT**.
2. Press ↓ to **DRAW MAP BOUNDARIES**. With the option highlighted, press **ENT** to check it (turn on) or uncheck it (turn off.)
3. After the option is set, press **EXIT** | **EXIT** to return to the page display.

### To turn on/off Fill Water With White

1. From the Map Page, press **MENU** | ↓ to **MAP DATA** | **ENT**.
2. Press ↓ to **FILL WATER WITH WHITE**. With the option highlighted, press **ENT** to check it (turn on) or uncheck it (turn off.)
3. After the option is set, press **EXIT** | **EXIT** to return to the page display.

## Map Overlays (Range Rings; Lat/Long Grid)

The map screen can be customized with four range rings and/or grids that divide the plotter into equal segments of latitude and longitude.

Range rings are handy for visually estimating distances on the map. The ring diameters are based on the current zoom range. For example: at the 100 mile zoom, the screen will show two rings with your current position in the center. The large ring touching the left and right sides of the screen is 100 miles in diameter (same as the zoom range). The second smaller ring is 50 miles in diameter (always 1/2 the zoom range).

The distance from your current position to the smaller ring (the ring's radius) is 25 miles (always 1/4 the zoom range). With the arrow keys and map cursor, you can scroll the map to see the third and fourth rings. In this example, the distance to the third ring is 75 miles and distance to the fourth ring is 100 miles from your current position.

### To turn on/off range rings:

1. From the Map Page, press **MENU** | ↓ to **MAP DATA** | **ENT**.
2. Press ↓, → to **RANGE RINGS**. With the option highlighted, press **ENT** to check it (turn on) and uncheck it (turn off.)
3. After the option is set, press **EXIT** | **EXIT** to return to the page display.

### To turn on/off Lat/Long Grid lines:

1. From the Map Page, press **MENU** | ↓ to **MAP DATA** | **ENT**.
2. Press ↓, to **LAT/LON GRID LINES**. With the option highlighted, press **ENT** to check it (turn on) and uncheck it (turn off.)
3. After the option is set, press **EXIT** | **EXIT** to return to the page display.

## Map Datum Selection

Maps and charts are based on a survey of an area covered by the map or chart. These surveys are called Datums. Maps using different datums will show the same latitude/longitude in different locations.

All datums are named. The GPS system is based on the WGS-84 datum, which covers the entire world. Other datums may also cover the entire world, or just a small portion of it. By default, your unit uses the WGS-84 datum. It, however, can show your position using any of 191 datums. Different datums can be selected. To change the datum:

1. Press **MENU** | **MENU** | ↓ to **GPS SETUP** | **ENT** | ↓ to **DATUM SELECTION** | **ENT**.
2. Use ↓ ↑ to select the desired datum, then press **ENT**.
3. To return to the last page displayed, press **EXIT** | **EXIT**.

A list of the datums used by this unit is in the back of this manual.



The Map Datum Menu.

## Map Detail Category Selection

This menu determines which of the mapping features are shown on the screen. This includes: waypoints, trails, icons, cities, highways, etc. You can turn on or off any of these items to customize the map.

To get to Map Categories:

1. From the Map Page, press **MENU** | ↓ to **MAP CATEGORIES DRAWN** | **ENT**.
2. Press ↑ ↓ to select a category or press → then press ↑ ↓ to select a subcategory. Press **ENT** to turn it off (no check) or on (checked.)
3. To return to the map display, press **EXIT** | **EXIT**.

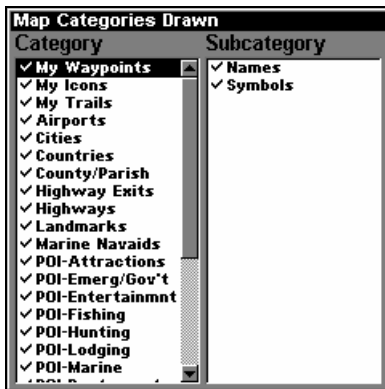

The Map Categories Drawn Menu.

## Map Orientation

By default, this receiver shows the map with north always at the top of the screen. This is the way most maps and charts are printed on paper.

In Track Up mode, map shows "N" and arrow to indicate north.

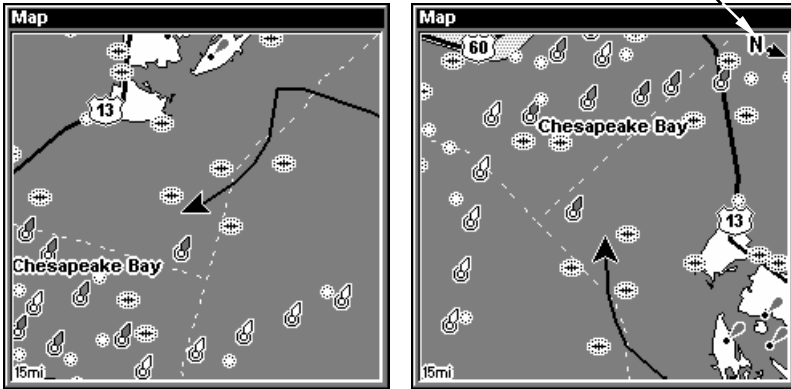

Map page shown in North Up mode (left) Map page shown in Track Up mode (right).

This is fine if you are always traveling due north. What you see to your left corresponds to the left side of the map, to your right is shown on the right side of the map, and so on. However, if you travel any other direction, the map doesn't line up with your view of the world.

To correct this problem, a track-up mode rotates the map as you turn. Thus, what you see on the left side of the screen should always be to your left, and so on.

Another option is course-up mode, which keeps the map at the same orientation as the initial bearing to the waypoint. When either the track-up or course-up mode is on, a "N" shows on the map screen to help you see which direction is north.

To change map orientation:

1. From the Map Page, press **MENU** | **↓** to **MAP ORIENTATION** | **ENT**.
2. Use **↑** | **↓** to select the desired mode, then press **ENT**.
3. Press **EXIT** | **EXIT** to return to the map page display.

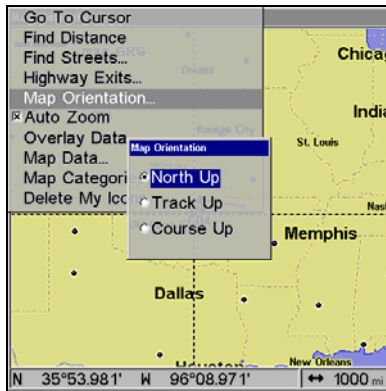

Map Orientation menu with the North Up map orientation option selected.

## NOTE

In North Up and Course Up, the present position arrow appears in the center of the map page. In Track Up, the position arrow appears centered in the lower third of the page.

## NauticPath™ USA Marine Charts

Your unit can display NauticPath electronic charts on MMCs. They work just like a MapCreate custom map on a MMC.

### Nautical Chart Notes

NauticPath charts contain notes or chart information, represented by circle-i Chart Note icons on the map display. An example is shown in the following figure.

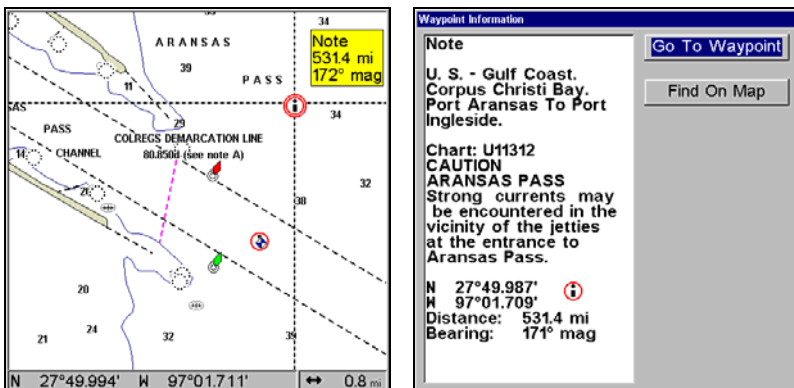

NauticPath chart showing Chart Note icon selected by cursor (left). Note information screen (right).

**To view Chart Note information:**

1. Use the arrow keys to move the cursor over a Chart Note icon. When it's selected, a pop-up name box appears.
2. Press **WPT** to display the Note Information screen.
3. To scroll through the Chart Note screen, use  $\uparrow$   $\downarrow$  arrow keys to read the information. To return to the main page display, press **EXIT** repeatedly.

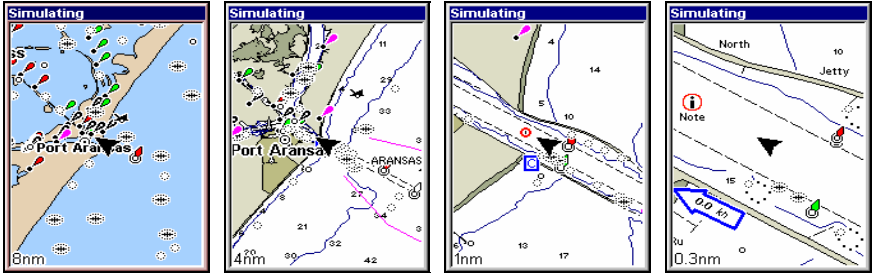

**Entrance to Aransas Pass on a NauticPath chart with 8-nautical mile zoom (left). Remaining images (left to right): same position at 4-nautical mile, 1-nautical mile and 0.3- nautical mile zoom ranges.**

**Port Information**

NauticPath charts contain Port Services information, represented by anchor icons on the map display. These icons will appear when you are zoomed in to a 4-nautical mile range. An example is displayed in the following figures.

**To view Port Services information:**

1. Use the arrow keys to move the cursor over a Port Services icon. When it is selected, a pop-up name box appears.
2. Press **WPT** to display the Port Services Information screen.

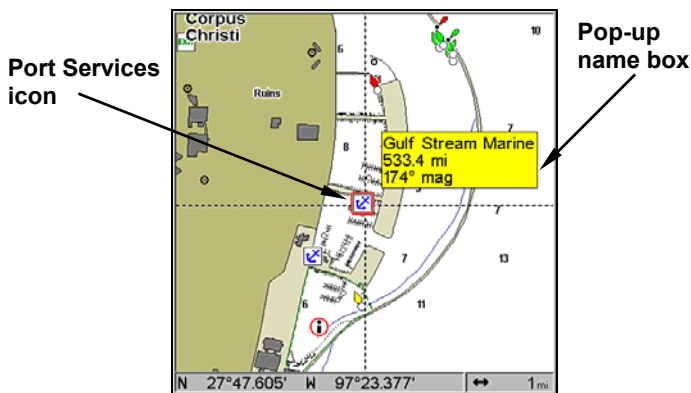

**NauticPath chart showing Port Services icon selected by cursor. When first highlighted, the Pop-Up name box appears.**

The Port Services information screen for a NauticPath chart contains all the service information in one window.

3. To scroll through the service information window, use  $\uparrow$   $\downarrow$  to see the types of services available. To return to the main page display, press **EXIT** repeatedly.

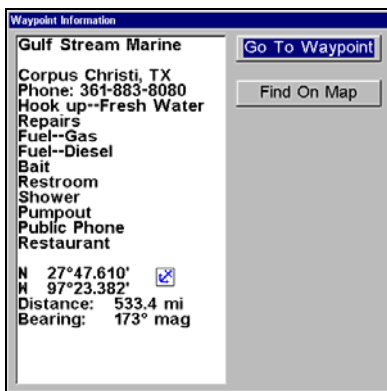

**Port Services information.**

### **Tidal Current Information**

NauticPath charts contain Tidal Current information, represented at large zoom ranges by a box icon with the letter "C." These icons will appear when you are zoomed in to a 6-mile range. The icon stands for a Tidal Current Station location. An example is displayed on the right.



When you zoom in to a sufficiently small zoom range (0.8 nautical mile), the icon becomes an animated arrow showing tidal current velocity and direction *for the selected tidal station* at the present time. At



larger zoom ranges, you can select the boxed "C" icon and it becomes an animated arrow with a pop-up name box (the name box disappears after a few seconds). Examples are displayed in the following figures.

**To view Tidal Current information:**

1. Use the arrow keys to move the cursor over a Tidal Current Station icon. When it is selected, a pop-up name box appears.
2. Press **WPT** to display the Tidal Current Information screen.

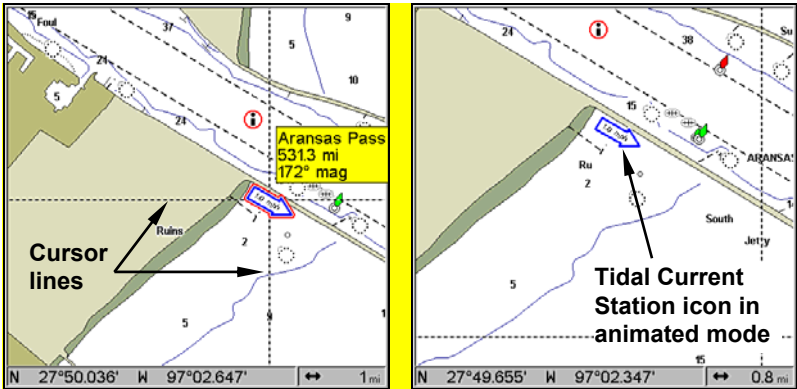

NauticPath chart showing Tidal Current Station icon selected by cursor (left). Tidal Current animated icon at .8-nautical mile range.

**Current Time Line**

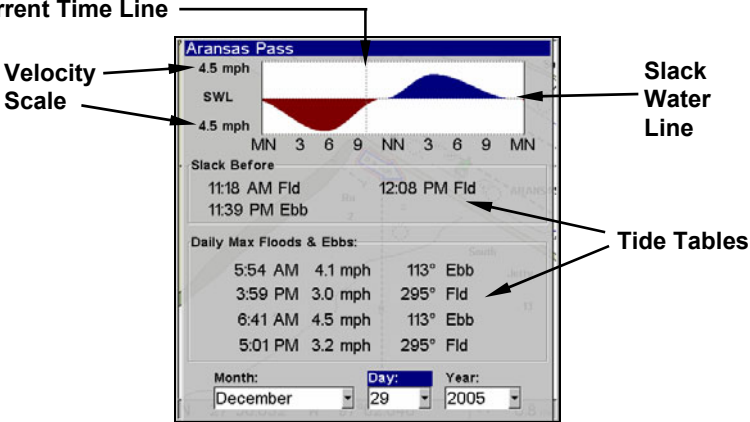

**Current Information screen.**

The Tidal Current Information screen displays daily tidal current data for this station on this date at the present time. The graph at the top of the screen is an approximate view of the flood and ebb pattern for the day, from midnight (MN), to noon (NN) to midnight (MN).

The velocity scale at the top left side of the graph changes dynamically based upon the maximum velocity of the current for that day.

Slack water, the period of little or no current, is represented by the Slack Water Line (SWL). The flood appears above the SWL and the ebb appears below the SWL. You can look up tidal current data for other dates by changing the month, day and year selection boxes.

**To select another date:**

- 1. Use ← → to highlight month, day or year, then press **ENT**.
- 2. Use ↑ ↓ to select the desired month, day or year and press **ENT**.

To clear the information screen, press **EXIT**.

**Tide Information**

NauticPath charts contain Tidal Information, represented at large zoom ranges by a box icon with the letter "T." These icons will appear when you are zoomed in to a 6-mile range. The icon stands for a Tidal Station location. An example is displayed at right.

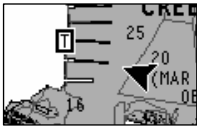

When you zoom in to a sufficiently small zoom range (0.8 nautical mile), the icon becomes an animated gauge showing a rising or falling tidal height for the selected station at the present time. At larger zoom ranges, you can select the boxed "T" icon and it becomes an animated gauge with a pop-up name box. The name box disappears seconds.

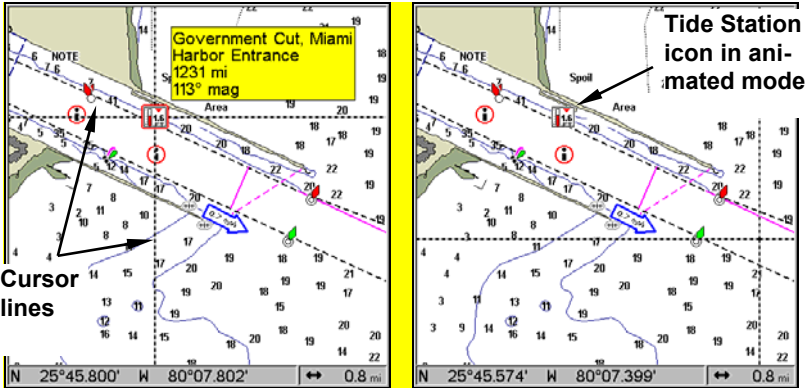

NauticPath chart showing Tide Station icon selected by cursor (left). Icon animates automatically without selection at the 0.8-mile zoom range (right). In the example above, the tide is at 0.9 feet and falling, as shown by the down arrow at the top of the icon.

**To view tide information:**

1. Use the arrow keys to move the cursor over a tide station icon. When it is selected, a pop-up name box appears.
2. Press **WPT** to display the Tide Information screen.

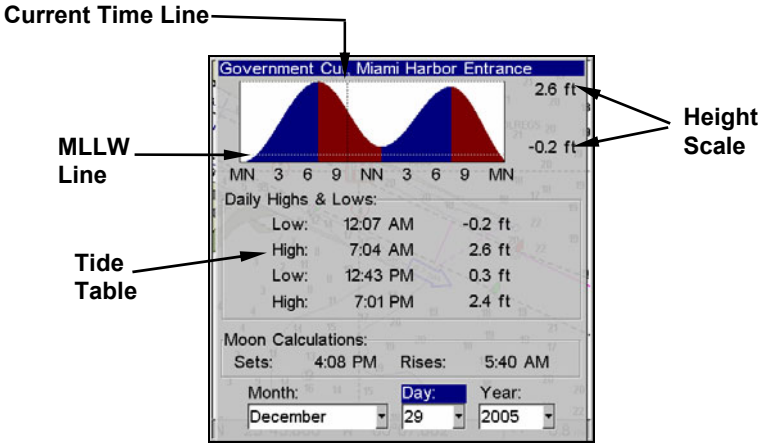

**Tide Information screen.**

The Tide Information screen displays daily tidal data for this station on this date at the present time. The graph at the top of the screen is an approximate view of the tidal range pattern for the day, from midnight (MN) to noon (NN) to midnight (MN). The dotted line across the graph is the Mean Lower Low Water line (MLLW).

The height scale on the top right side of the graph changes, based upon the maximum *range* of the tide for that day. The MLLW line also adjusts its position as the height scale changes.

You can look up tidal data for other dates by changing the month, day and year selection boxes. To select another date:

1. Use ← → to highlight month, day or year, then press **ENT**.
2. Use ↑ ↓ to select the desired month, day or year and press **ENT**.

To clear the information screen, press **EXIT**.

## Navionics® Charts

Your unit can also display Navionics electronic charts on MMCs. Like NauticPath, Navionics charts contain tide and port service information.

**NOTE:**

The primary operational difference between a NauticPath chart and a Navionics chart is the way the chart data is set up for display. NauticPath charts are ready for display as soon as they are

inserted into the unit. Navionics charts must be inserted into the unit, then selected as a Map Choice option in the Map Data menu.

### To display a Navionics chart:

1. Install the Navionics MMC in the memory card compartment and turn on the unit. (For full card install instructions, see Sec. 2.)
2. From the Map Page, press **MENU** | **↓** to **MAP DATA** | **ENT** | **↓** to **MAP CHOICE** | **ENT**. Select the *Map Name*, then press **ENT** | **EXIT** | **EXIT**.

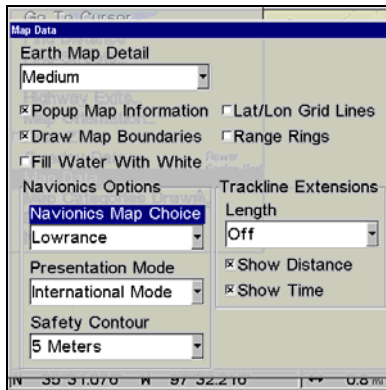

Navionics Map Choice highlighted. Press Ent to select the desired Navionics map from the Map Choice drop down box.

### WARNING:

You should never format the MMC containing your Navionics chart. Formatting the MMC will permanently erase the chart from the card.

## Overlay Data

On any Page display except Satellite Status, you can overlay additional GPS or navigation data on the screen with the Overlay Data command. For example, if you left your watch at home, you could display the local time on top of the map. Or, if you wanted to see details about your route and trip, you could show your bearing, course, average speed and trip distance.

The various data available from your unit are divided into categories in the Overlay Data menu. These categories include GPS Data, Navigation, Trip Calculator, Time, Sonar Data and Miscellaneous Data.

You can select items from any of these categories for display, in any combination — the category divisions are there only to help you sort through the information.

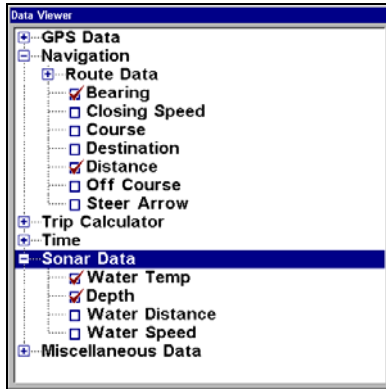

Overlay Data with Navigation and Sonar Data categories expanded.

**To overlay information on your screen:**

1. Press **MENU** | ↓ to **OVERLAY DATA** | **ENT**.
2. If you currently have any overlay data on your screen, it will be listed here. Select (**ENTER TO ADD**) and press **ENT**. The data viewer shows information categories with "+" or "-" symbols next to each category name. A category with a "+" next to it is *expandable*, meaning its contents are hidden.

Selecting the category name and pressing **ENT** will show the category's contents, so you can choose items within it. An expanded category (one with a "-" next to its name) can be collapsed to hide its contents. Just select the category name and press **ENT**.

3. Expand any categories that might contain data you want to display. Then press ↓ or ↑ to select a data option.
4. With the data option highlighted, press **ENT** to check it (turn on) and uncheck it (turn off). As you turn it on, the data will appear on top of the screen. Every Page display has a maximum number of items you can show using the Overlay Data command.
5. After the desired changes are made, press **EXIT** | **EXIT** to return to the page display.

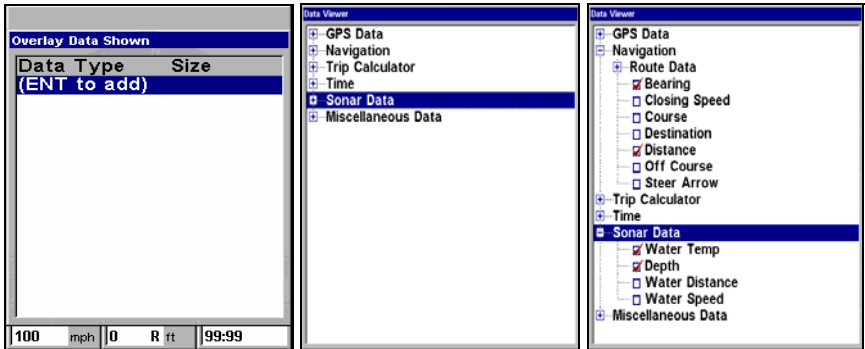

From Overlay Data Shown (left) press **ENT** to see Data Viewer (center). Select a category and press **ENT**. Next, select information to show on screen and press **ENT** to check it and turn it on (right).

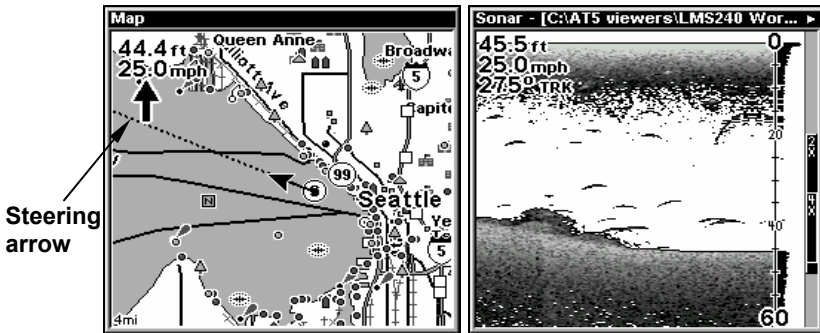

Map Page shows boat cruising Puget Sound, Washington with Overlay Data turned on (left). This example shows Depth, Ground Speed and the Steering Arrow. Note that the Steering Arrow always points directly to the destination you are navigating toward. In this case, the boater is on a northwest course of 275°. Since the helmsman is on course, the Steering Arrow is pointing straight ahead. If the helmsman veered off course, the arrow would show which direction to steer to get back on course. Sonar Page with Overlay Data turned on (right), showing Depth, Ground Speed and the Track the boat is following.

### To remove overlaid data:

1. While on the Page that shows the item or items you want to remove, press **MENU** | **↓** to **OVERLAY DATA** | **ENT**.
2. You will see a list of the overlay data currently displayed. Select the item you want to remove from your display and press **ENT** | **ENT** to remove the data. To remove another item, highlight the item and press **ENT** | **ENT**.
3. When you have finished removing Overlay Data, press **EXIT** to return to the map page display.

**NOTE:**

You also can remove data directly from the Data Viewer menu by repeating the steps used to add overlay data. Highlight the overlay data currently displayed, then press **ENT**, unchecking the data option, which will remove it from the display..

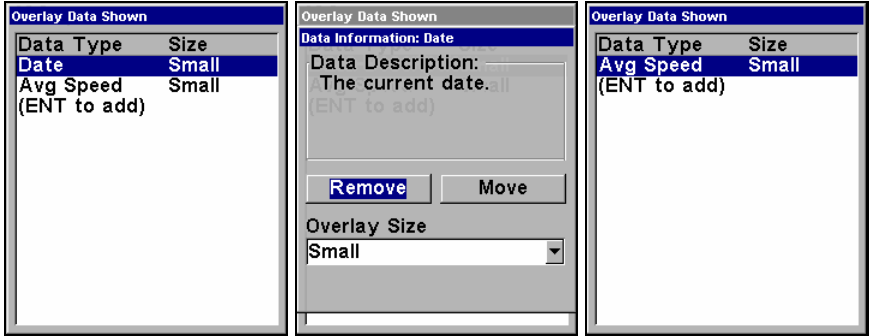

Overlay Data Shown, with Date option selected (left). Press **ENT** to access **REMOVE** option (center). Press **ENT** again to remove item and return to Overlay Data Shown (right).

**To move overlaid data:**

You may find it useful to move or rearrange overlay data on your display.

1. From one of the Map Pages, press **MENU** | ↓ to **OVERLAY DATA** | **ENT**.
2. You will see a list of the overlay data currently displayed. Select the item you want to move and press **ENT** | → to **MOVE** | **ENT**.
3. The data begins to flash on your screen. Use ↑ ↓, ← → to move the data to a new location on the screen.
4. Press **EXIT** | **EXIT** to return to the map display.

**NOTE:**

The **Customize** command and the **Overlay Data** command both use the same information categories. The difference between the two commands is that **Customize** changes only the data in digital data boxes, while **Overlay Data** changes the data on the floating freely on the screen but does not alter data in digital data boxes. For information on customizing digital data boxes see **Customize Page Displays** on page 86.

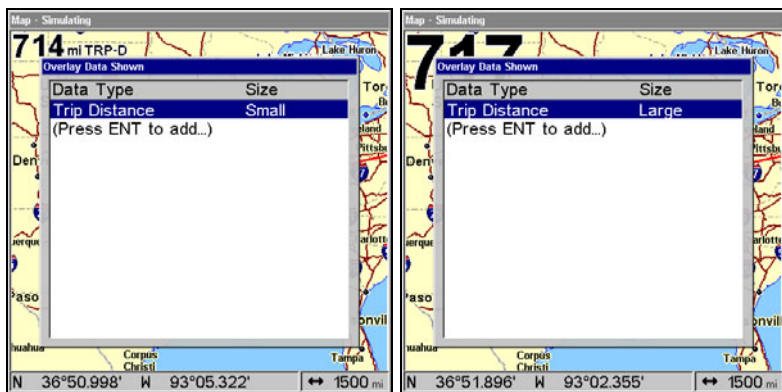

**Trip Distance set to small size in the Overlay Data Shown menu (left).  
Trip Distance set to Large size (right).**

### To change displayed data font size:

1. From the Map or Sonar page, press **MENU** |  $\downarrow$  to **OVERLAY DATA** | **ENT**.
2. Press  $\downarrow$   $\uparrow$  to select the desired data type, then use  $\leftarrow$   $\rightarrow$  to enlarge or reduce the size of the overlay data on the map display.
3. Press **EXIT** to return to the map display. The selected data type will be displayed in the new size. (To change the font size for another Data Type, repeat these steps, beginning with step 2 above.)

### NOTE:

Some data types can be displayed in only one font size. If that is the case, the Data Size box will not be displayed for that data type.

## Pop-up Help

Help is available for virtually all menus in this unit. By leaving a menu item or command highlighted for a few seconds, a pop-up message will appear, giving a brief description of the functions purpose. This feature is on by default.

### To set up Pop-up Help:

1. Press **MENU** | **MENU** |  $\downarrow$  to **SYSTEM SETUP** | **ENT** |  $\downarrow$  to **POPUP HELP**.
2. With the option highlighted, press **ENT** to check it (turn on) and uncheck it (turn off.)
3. After the option is set, press **EXIT** | **EXIT** to return to the page display.



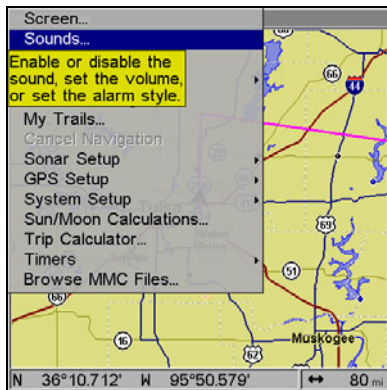
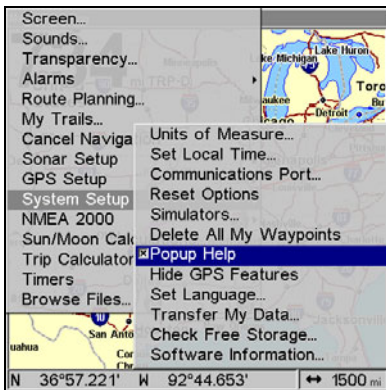

Pop-up Help command highlighted on System Setup menu (left). Pop-up Help message for Sounds (right).

## Reset Options

The Reset Options command allows you to switch unit features and functions back to factory default settings.

1. Press **MENU** | **MENU** | ↓ to **SYSTEM SETUP** | **ENT** | ↓ to **RESET OPTIONS** | **ENT** | ← to **YES** | **ENT**.

### NOTE:

Reset Options does *not* erase any waypoints, routes, icons, plot trails or sonar logs.

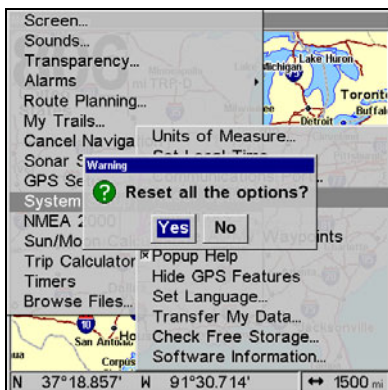
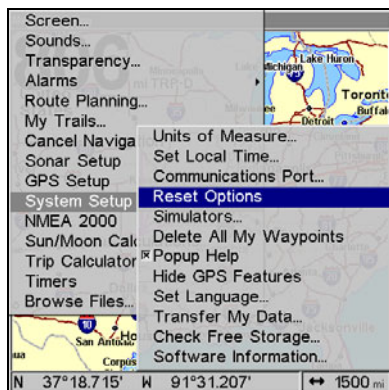

Reset Options highlighted on the System Setup menu (left). Reset Options confirmation message (right).

## Screen Contrast and Brightness

To adjust Contrast:

1. Press **MENU | MENU | ENT**.
2. Highlight **CONTRAST**, then use ← → to move the contrast adjustment bar. The left end of the scale is the lowest contrast level. The right end is the highest contrast level.

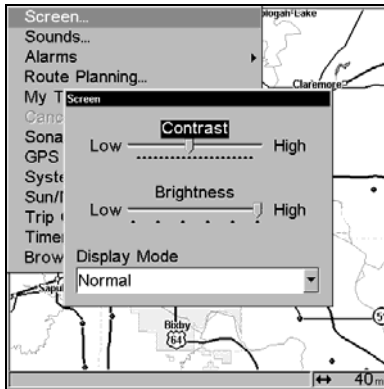

The Screen Menu with Contrast bar selected.

To adjust the display's brightness:

1. Press **MENU | MENU | ENT**.
2. Press ↓ to **BRIGHTNESS**. Press ← → to move Brightness Control bar. The left end of the scale is the lowest brightness level. The right end of the scale is the highest brightness level.

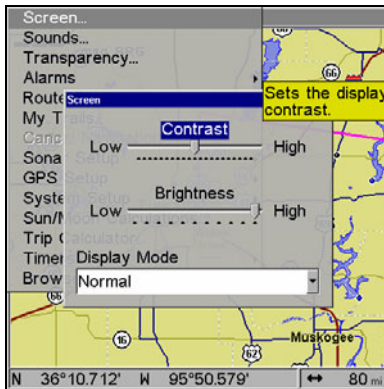

Display Mode menu.

## To adjust the screen's display mode:

1. Press **MENU | MENU | ENT**.
2. Press  $\downarrow$  to **DISPLAY MODE | ENT**, which will open the Display Mode menu with three options: Normal, High Contrast and Night Viewing.
3. Select the desired mode and press **ENT**. Press **EXIT | EXIT** to return to the map display.

## Set Language

This unit's menus are available in 10 languages: English, French, German, Spanish, Italian, Danish, Swedish, Russian, Dutch and Finnish. To select a different language:

1. Press **MENU | MENU |  $\downarrow$  to SYSTEM SETUP | ENT**.
2. Highlight **SET LANGUAGE | ENT**.
3. Use  $\downarrow \uparrow$  to select the desired language and press **ENT**. All menus now will appear in the language you selected.

## Set Local Time

Using the local time setting is useful when estimating local arrival time while navigating.

1. Make sure your unit has acquired your position, then press **MENU | MENU**, highlight **SYSTEM SETUP** and **ENT**.
2. Highlight **SET LOCAL TIME** and press **ENT**.
3. Local time will be highlighted, so press **ENT**. Use  $\uparrow \downarrow$  to change the first character, then press  $\rightarrow$  to move the cursor to the next character. Repeat those steps until the time has been set. Press **ENT**.

## To set the Month:

1. Make sure your unit has acquired your position, then press **MENU | MENU**, highlight **SYSTEM SETUP** and **ENT**.
2. Highlight **SET LOCAL TIME** and press **ENT**.
3. Select **MONTH** and **ENT**. Use  $\uparrow \downarrow$  to select the desired month and press **ENT**.

## To set the Day:

1. Make sure your unit has acquired your position, then press **MENU | MENU**, highlight **SYSTEM SETUP** and **ENT**.
2. Highlight **SET LOCAL TIME** and press **ENT**.
3. Highlight **DAY** and press **ENT**. Use  $\uparrow \downarrow$  to select the desired day and press **ENT**.

### **To set the Year:**

1. Make sure your unit has acquired your position, then press **MENU | MENU**, highlight **SYSTEM SETUP** and **ENT**.
2. Highlight **SET LOCAL TIME** and press **ENT**.
3. Select **YEAR** and press **ENT**. Use **↑ ↓** to select the year and press **ENT**.

### **To select Time Format:**

1. Make sure your unit has acquired your position, then press **MENU | MENU**, highlight **SYSTEM SETUP** and **ENT**.
2. Highlight **SET LOCAL TIME** and press **ENT**.
3. Select the desired format, 12 Hour or 24 Hour, and press **ENT**.

### **To select a Date Format:**

1. Make sure your unit has acquired your position, then press **MENU | MENU**, highlight **SYSTEM SETUP** and **ENT**.
2. Highlight **SET LOCAL TIME** and press **ENT**.
3. Select the desired Date Format, Month/Day/Year, Day/Month/Year or Year/Month/Day and press **ENT**.

### **To Configure DST:**

Configure DST allows your unit to automatically adjust to Daylight Saving Time. Select the country with DST rules that match your region or simply accept the default.

1. Make sure your unit has acquired your position, then press **MENU | MENU**, highlight **SYSTEM SETUP** and **ENT**.
2. Select **SET LOCAL TIME** and press **ENT**.
3. Highlight the **CONFIGURE DST** button and press **ENT**. From the Country menu, select the country with DST rules that match your region.
4. Press **EXIT** repeatedly to return to the map display.

### **Show WAAS Alarm**

When the signal is available, your unit will automatically use WAAS to boost the accuracy of the position fix. When the WAAS signal is lost or acquired, an alarm message appears. Since the U.S. government is still developing the WAAS system, its not unusual for a GPS/WAAS receiver to frequently lose and reacquire its lock on a WAAS satellite. That can result in the alarm repeatedly going on and off. You have the option of turning off the WAAS Acquired/Lost alarm without affecting how the unit uses WAAS.

## To turn on/off the WAAS Alarm:

1. Press **MENU | MENU | ↓** to **GPS SETUP | ENT | ↓** to **SHOW WAAS ALARM**.
2. With the option highlighted, press **ENT** to check it (turn on) or uncheck it (turn off) the WAAS Alarm.
3. Press **EXIT | EXIT** to return to the map display.

## To Require WAAS:

1. Press **MENU | MENU | ↓** to **GPS SETUP | ENT | ↓** to **REQUIRE WAAS**.
2. With the option highlighted, press **ENT** to check it (turn on) or uncheck it (turn off).
3. Press **EXIT | EXIT** to return to the map display.

## Software Version Information

From time to time, Lowrance updates the operating system software in some of its products. These software upgrades are usually offered to customers as free downloads from our web site, [www.lowrance.com](http://www.lowrance.com). These upgrades make the unit perform better and/or introduce a new feature or function. You can find out what software version is running in your unit by using the Software Information command.

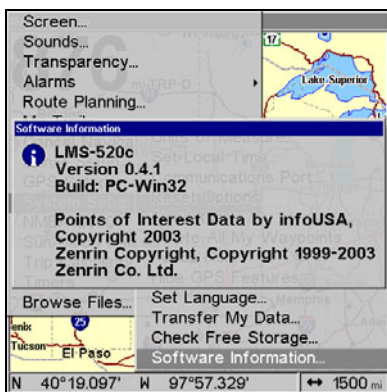

The Software Information screen.

## To access Software Information:

1. Press **MENU | MENU**, highlight **SYSTEM SETUP** and press **ENT**.
2. Select **SOFTWARE INFO** and press **ENT**. Software information will be displayed on the screen.
3. Press **EXIT** repeatedly to return to the map display.

## Sounds and Alarm Sound Styles

Sounds triggered by key strokes and alarms can be turned off or adjusted to a desired level.

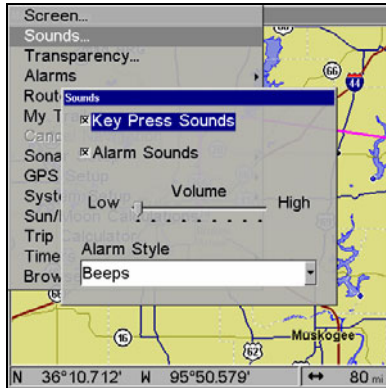

The Sounds menu.

### To set Key Press Sounds:

1. Press **MENU | MENU**, select **SOUNDS** and press **ENT**.
2. Highlight **KEY PRESS SOUNDS** and press **ENT** to check it (turn on) or uncheck it (turn off).
3. Press **EXIT | EXIT** to return to the map display.

### To set Alarm Sounds:

1. Press **MENU | MENU**, select **SOUNDS** and press **ENT**.
2. Highlight **ALARM SOUNDS** and press **ENT** to check it (turn on) or uncheck it (turn off).
3. Press **EXIT | EXIT** to return to map page display.

### To set Volume:

1. Press **MENU | MENU**, select **SOUNDS** and press **ENT**.
2. Highlight **VOLUME** and use **← →** to move the Volume control bar. The left end of the scale is low volume. The right end of the scale is high volume.
3. Press **EXIT | EXIT** to return to map display.

### To set Alarm Style:

1. Press **MENU | MENU**, select **SOUNDS** and press **ENT**.
2. Highlight **ALARM STYLE** and press **ENT**.
3. Use **↑ ↓** to select the desired style and press **ENT**.
4. Press **EXIT | EXIT** to return to the map display.

# Track Smoothing

This is a factory setting on the GPS Setup menu that *should always be left on*. When stopped or traveling at slow speeds (such as walking or trolling), Track Smoothing prevents wandering of trails, the steering arrow, compass rose and a map in track-up mode.



Track Smoothing highlighted on the GPS Setup menu.

# Trail Options

There are several options you can use with trails. Some affect all trails, other options can be applied to a particular trail. You can change the way trails are updated, display or hide trails, create a new trail, delete a trail and edit a trail's name, color, pattern and visibility.

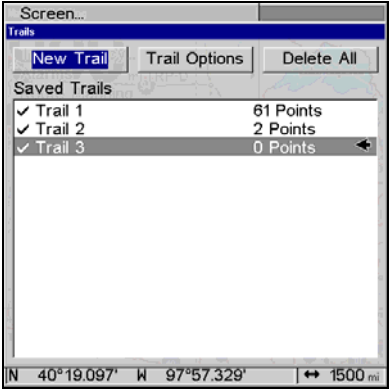

The Trails Menu.

### To create a New Trail:

1. Press **MENU | MENU**, highlight **MY TRAILS** and press **ENT**.
2. Highlight **NEW TRAIL** and press **ENT**. The Edit Trail menu will appear, allowing you to Edit the trails name, color, pattern, maximum points, trail status (active or inactive) and trail visibility. You can also navigate the trail or delete the trail.

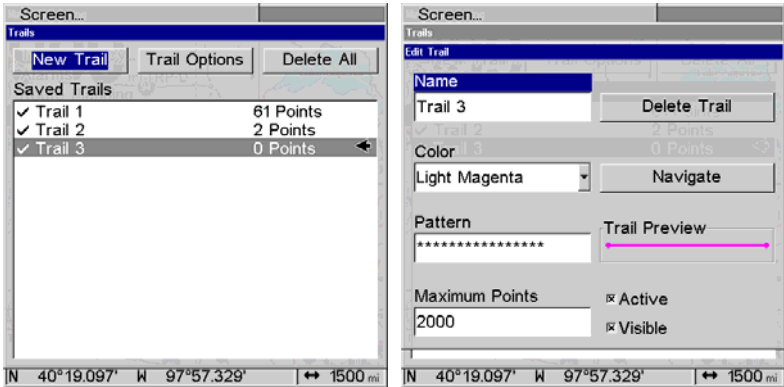

New Trail selected on the Trails menu (left). Edit Trails menu (right).

### To Delete all Trails

1. Press **MENU | MENU**, select **MY TRAILS** and press **ENT**.
2. Highlight **DELETE ALL** and press **ENT**. The following Warning will appear: *Delete All Trails?*
3. Select **Yes** and press **ENT**. You will be returned to the Trails screen, where all trails have been deleted.
4. Press **EXIT** repeatedly to return to the map display.

### Update Trail Option

The Update Trail menu allows you to change the way trail updates occur. There are three options: Auto, Time and Distance.

In automatic mode, the unit does not update the plot trail while you are traveling in a straight line. When you deviate from a straight line, the unit places a plot point onto the trail. This conserves plot trail points. If a plot trail uses all of the available points allotted to it, the beginning points are deleted and replaced by points at the end of the trail.

Selecting Time as the method for updating a trail will automatically place trail points at a duration of your choosing. You can set the unit to place trail points placed at any duration between 1 second to 9999 seconds. The default setting is 3 seconds. Updating a trail by Distance will place trail points when you move a distance of your choosing.



You can have trail points placed at any distance between 0.01 mile/nm/km to 9.99 mile/nm/km. The default setting is 0.10 mi.

**WARNING:**

If you *uncheck* the Update Trail option, automatic trail creation and recording will be turned *off*. You must turn it back on to record trails. The default setting is on.

**To select a Trail Update Option:**

1. Press **MENU | MENU**, select **MY TRAILS** and press **ENT**.
2. Highlight the **TRAIL OPTIONS** button and press **ENT**. The Trail Options menu will appear with three update criteria: Auto, Time and Distance.

**NOTE:**

The Update Active Trail checkbox should be checked (turned on). If it is unchecked (turned off), your trails will not be updated. To turn it on, highlight **UPDATE ACTIVE TRAIL** and press **ENT**.

3. Highlight the desired method for updating trails and press **ENT**. If you choose Time or Distance as your update criteria, you can input the desired update rate (Time) or desired Update Distance (Distance) in the dialog box that appears at the bottom of the menu.
4. To input your Update Rate or Update Distance, highlight Update Rate or Update Distance and press **ENT**. Use  $\uparrow \downarrow$ ,  $\leftarrow \rightarrow$  to input the desired setting and press **ENT**.
5. Press **EXIT** repeatedly to return to the map display.

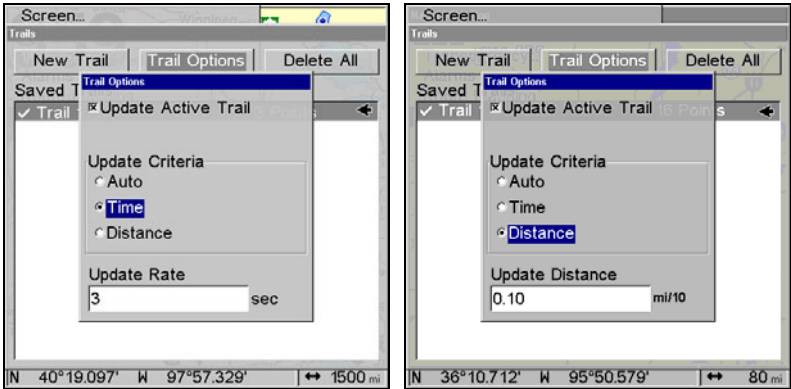

Time set as the update criteria (left). Notice the Update Rate dialog box at the bottom of the menu. Distance is set as the update criteria (right). The Update Distance dialog is at the bottom of the menu.

### To delete a Trail:

1. Press **MENU | MENU**, select **MY TRAILS** and press **ENT**.
2. Select the desired trail from the Saved Trails list and press **ENT**. The Edit Trail menu will appear.
3. Highlight **DELETE TRAIL** and press **ENT**. The following message will appear: *Delete this trail?* Select **YES** and press **ENT**.
4. Press **EXIT** repeatedly to return to the map display.

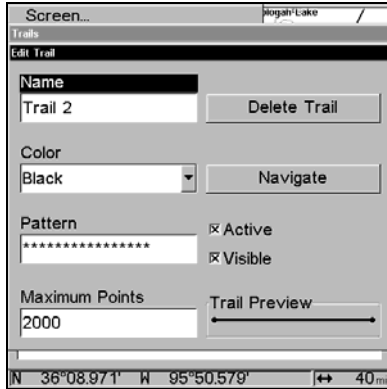

Edit Trail menu.

### Trail Visible/Invisible and Other Trail Options

The name, maximum number of points in the trail, activity, and visibility are all changed on the Edit Trail menu screen. The Active setting determines whether or not the unit is recording new points for a particular trail.

On the Edit Trail menu, press  $\downarrow \uparrow$  to highlight the section you wish to change, then press **ENT**. Make your changes, then press **EXIT** to close the menu. Related trail functions are discussed in further detail under the Trails topic in Sec. 7, *Advanced GPS Operations*.

### Transparency

Use the transparency menu to adjust the transparency of menu windows. A high transparency allows you to continue monitoring the screen's display while adjusting feature settings, though the text of the menus may fade until it is unreadable. A low transparency will usually make menu text easier to read, at the cost of watching your display.

Experiment with this feature until you find the right level of transparency for your eyes.



Transparency selected on main menu.

### To adjust Transparency level:

1. Press **MENU | MENU | ↓** to **TRANSPARENCY | ENT**. The **TRANSPARENCY** slider bar appears.
2. Use **↑ ↓** to move the bar. Move the bar to the bottom of the scale to eliminate transparency. Moving the bar to the top of the scale will provide the greatest level of transparency.
3. Press **EXIT** to return to the map display.

### Units of Measure

This menu sets the speed and distance (statute or nautical miles, meters), depth (feet, fathoms, or meters), temperature (degrees Fahrenheit or Celsius) and heading (true or magnetic) units.

#### To change Units of Measure:

##### To set Speed/Distance:

1. Press **MENU | MENU**, select System Setup and press **ENT**. **UNITS OF MEASURE** will be highlighted, so press **ENT**.
2. Speed/Distance will be highlighted. Press **ENT**.
3. Use **↑ ↓** to select one of the following options: Statute, Nautical or Metric. Press **ENT**.
4. Press **EXIT** repeatedly to return to the sonar display.

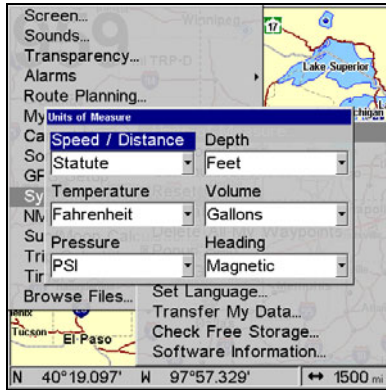

### Units of Measure Menu.

#### To set Temperature units:

1. Press **MENU | MENU**, select System Setup and press **ENT**. **UNITS OF MEASURE** will be highlighted, so press **ENT**.
2. Highlight **TEMPERATURE** and press **ENT**.
3. Use **↑ ↓** to select one of the following options: Fahrenheit, Celsius or Kelvin. Press **ENT**.
4. Press **EXIT** repeatedly to return to the sonar display.

#### To set Pressure units:

1. Press **MENU | MENU**, select System Setup and press **ENT**. **UNITS OF MEASURE** will be highlighted, so press **ENT**.
2. Highlight **PRESSURE** and press **ENT**.
3. Use **↑ ↓** to select one of the following options: Millibars, Bars, PSI, Hectopascals or Kilopascals. Press **ENT**.
4. Press **EXIT** repeatedly to return to the sonar display.

#### To set Depth units:

1. Press **MENU | MENU**, select System Setup and press **ENT**. **UNITS OF MEASURE** will be highlighted, so press **ENT**.
2. Highlight **DEPTH** and press **ENT**.
3. Use **↑ ↓** to select one of the following options: Feet, Fathoms or Meters. Press **ENT**.
4. Press **EXIT** repeatedly to return to the sonar display.

#### To set Volume units:

1. Press **MENU | MENU**, select System Setup and press **ENT**. **UNITS OF MEASURE** will be highlighted, so press **ENT**.

2. Highlight **VOLUME** and press **ENT**.
3. Use  $\uparrow$   $\downarrow$  to select one of the following options: Gallons or Liters. Press **ENT**.
4. Press **EXIT** repeatedly to return to the sonar display.

**To set Heading units:**

1. Press **MENU | MENU**, select System Setup and press **ENT**. **UNITS OF MEASURE** will be highlighted, so press **ENT**.
2. Highlight **HEADING** and press **ENT**.
3. Use  $\uparrow$   $\downarrow$  to select one of the following options: True or Magnetic. Press **ENT**.
4. Press **EXIT** repeatedly to return to the sonar display.

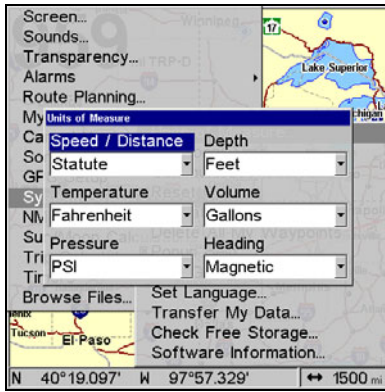

**The Units of Measure Menu.**

**To set Speed/Distance Unit of Measure:** Press  $\uparrow$  or  $\downarrow$  to change the Speed/Distance, then press **ENT**. After the option is set, press **EXIT | EXIT | EXIT** to return to the page display.

**To set Heading:** Press  $\uparrow$  or  $\downarrow$  to change the heading type, then press **ENT**. After the option is set, press **EXIT | EXIT | EXIT** to return to the page display.

# Notes

## Section 9: Searching

### NOTE:

The background map loaded in your unit lets you to search for U.S. Interstate Highway exits and exit services, as well as some land features, including cities and lakes. For a full set of searchable land features, including landmarks, streets and Points of Interest, you must load your own high-detail custom map produced with our MapCreate 6 software. For a complete description of what detail is found in the background map and custom MapCreate maps, see page 108. (Remember, our pre-made FreedomMaps contain all the same detail found in custom-made MapCreate maps.)

This unit's varied search functions all begin with either the Find Waypoint menu or the Map Page menu. Press **WPT** and the Find Waypoint menu appears for waypoints and Points of Interest (POI). From the Map Page, press **MENU** and the Map Page menu appears for streets and highway exits.

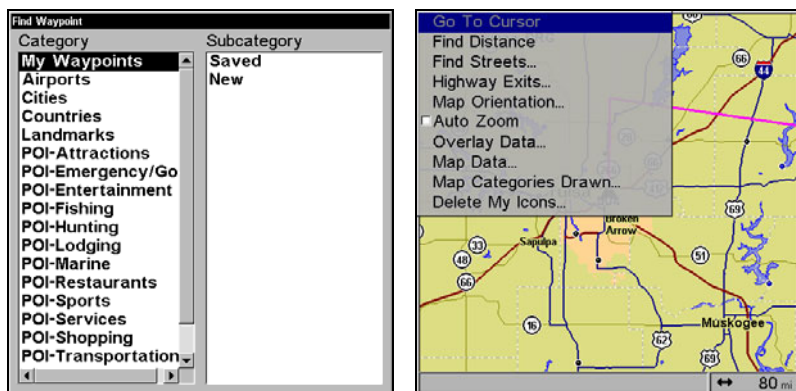

Find Waypoint menu (left). Map Page menu (right).

### NOTE:

You can search for items after the unit has acquired a position, or while using the unit in simulator mode. Distance and bearing to the selected item will be calculated from the unit's current position, or the last known position if operating in simulator mode or without a position determined). You can look up items by name or search for items nearest to you.

## Find Streets

1. From a Map Page, press **MENU** | ↓ to **FIND STREETS** | **ENT**.
2. Press **ENT** to search in the Street field.
3. To enter a street name, press ↓ to **STREET** | **ENT**. There are two options:  
**A.** You can spell out the name in the top selection box. Press ↑ or ↓ to change the first letter, then press → to move the cursor to the next letter and repeat until the name is correct, then press **ENT** | **ENT**.  
**B.** Jump down to the lower selection list by pressing **ENT**, then press ↓ or ↑ to select a street name from the list, then press **ENT**. The street name you selected is now in the street field.

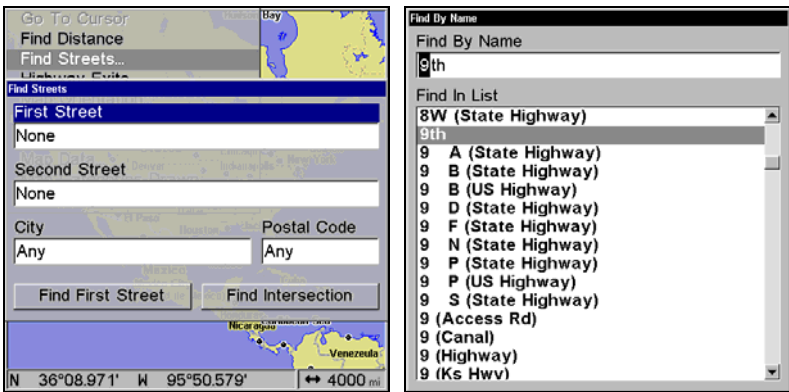

Finds Streets menu (left). Find Street by Name menu (right).

4. To enter a city name, press ↓ to **CITY** | **ENT**. You will be asked if you want to find streets only within a particular city. This option is designed so you can limit an address search to a single city if necessary (see the following note).

If you select yes, there are two options: **A.** You can spell out the city name in the top selection box. Press ↑ or ↓ to change the first letter, then press → to move the cursor to the next letter and repeat until the name is correct, then press **ENT** | **ENT**. **B.** Jump down to the lower selection list by pressing **ENT**, then press ↓ or ↑ to select a city name from the list, then press **ENT**. The city name you selected is now in the city field.

### NOTE:

We recommend that you do *not* enter a city name unless the list you are given is too large when searching without it. This unit can actually search quicker when you don't enter a city.



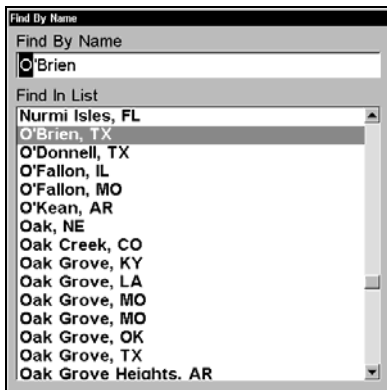

Find By Name menu with list of cities.

## Find Any Item Selected by Map Cursor

With a POI or map feature selected by the cursor, press **WPT**. To return to the previous page, press **EXIT**.

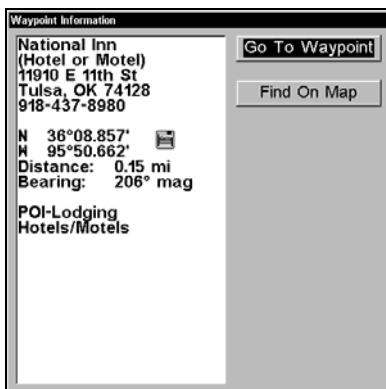
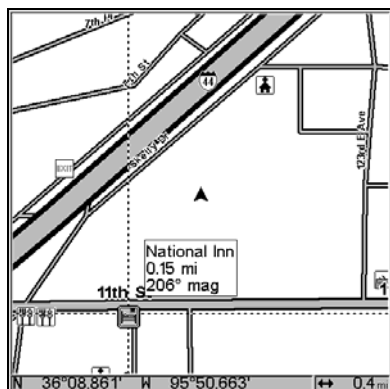

A POI selected by the cursor (left). POI information screen (right).

### NOTE:

Since the Go To Waypoint command is highlighted, you can navigate to the selected POI by pressing **ENT|EXIT** while in the POI Waypoint Information screen.

## Find Interstate Highway Exits

1. From the Map Page, press **MENU** | ↓ to **HIGHWAY EXITS** | **ENT**, which calls up the Find Exit menu.

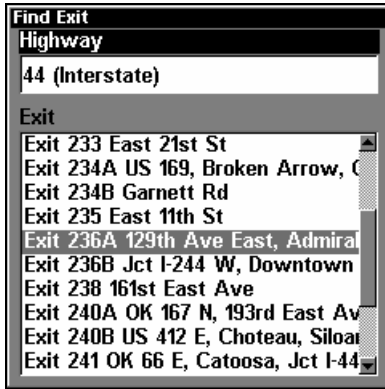

The Find Exit menu.

2. First, select a highway name by pressing **ENT**, which calls up the Find By Name menu. There are two highway search options: **A.** You can spell out the highway name in the top selection box. Press  $\uparrow$  or  $\downarrow$  to change the first letter, then press  $\rightarrow$  to move the cursor to the next letter and repeat until the name is correct, then press **ENT** | **ENT**. **B.** Jump down to the lower selection list by pressing **ENT**, then press  $\downarrow$  or  $\uparrow$  to select a highway from the list, then press **ENT**.

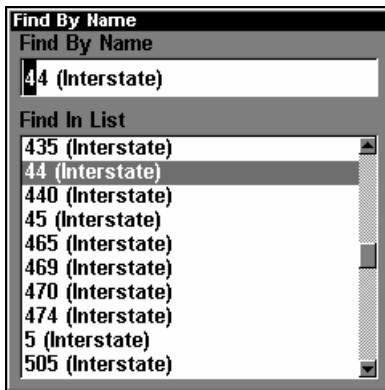

Find By Name menu.

3. Once you have selected a highway name you can then select an exit. Press  $\downarrow$  to switch to the Exit List, then press  $\downarrow$  or  $\uparrow$  until you highlight the exit, then press **ENT**.

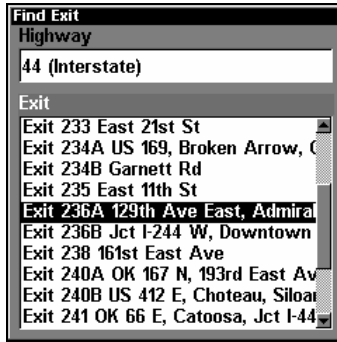

Find Exit menu with an exit selected in the Exit List.

4. In the Exit Information screen you have two choices. **A.** Press **ENT** to navigate or "go to" the exit. **B.** Press **→|ENT** to find the exit on the map.

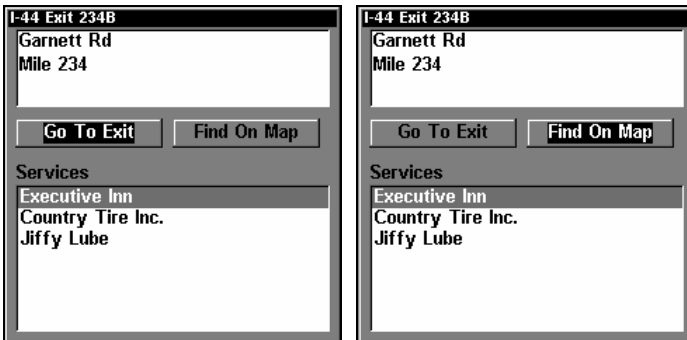

Go To Exit highlighted (left). Find On Map selected (right).

**Tip:**

You can also look up some additional information on the Exit Services located near this exit. Press **↓** to **SERVICES|**press **↓ ↑** to select *Service Name|ENT*.



Exit Information screen (left). General location and amenities information (right).

## Find Map Places or Points of Interest (POI)

1. Press **WPT**, press  $\downarrow$  or  $\uparrow$  to select a map place or POI category, then press **ENT**. (To narrow your search, press  $\rightarrow$  then press  $\downarrow$  or  $\uparrow$  to select a subcategory before pressing **ENT**.) You will be given two options; Search By Name or By Nearest.

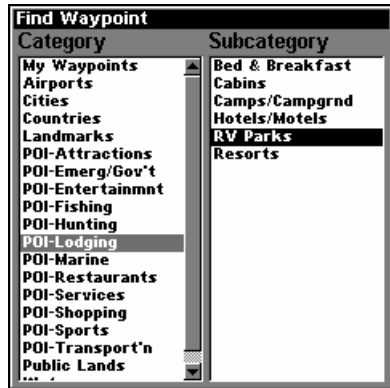
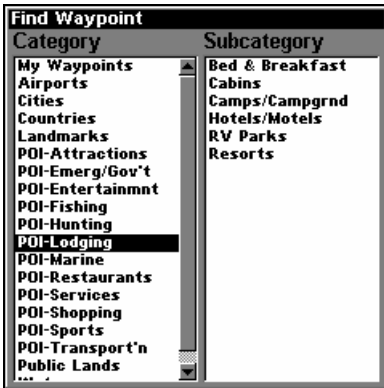

Find Waypoint menu with Lodging POI category selected (left) and with the RV Parks subcategory selected (right).

2. To search by the nearest POI: press  $\downarrow$  | **ENT**. The find by nearest menu will show a calculating screen, then a list of the nearest POI's will appear. Press  $\downarrow$   $\uparrow$  to the selected POI and press **ENT** to call up the POI's Waypoint Information screen.

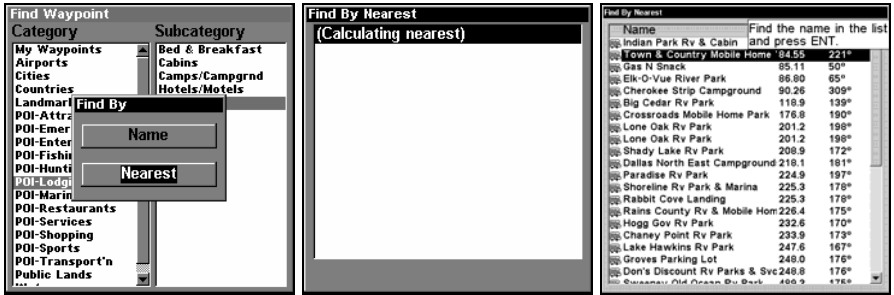

Find by Nearest option, left, Calculating screen, center, POI list, right.

3. To search by the name of a POI: press **ENT**. There are two options: **A**. You can spell out the POI in the top selection box. Press **↑** or **↓** to change the first letter, then press **→** to move the cursor to the next letter and repeat until the name is correct, then press **ENT** | **ENT**. **B**. Jump down to the lower selection list by pressing **ENT**, then press **↓** or **↑** to select a POI from the list, then press **ENT** to call up the POI's Waypoint Information screen.

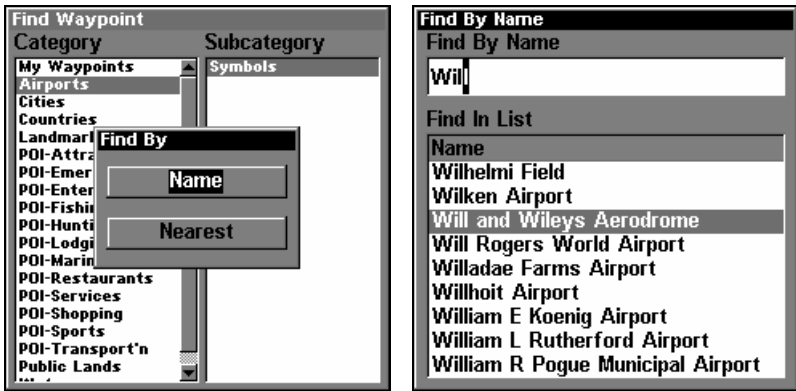

Find by Name option, left, Find by Name menu, right.

4. When the POI's Waypoint Information screen is displayed, you can choose to Go To the POI waypoint by pressing **ENT** or find it on the map by pressing **→** | **ENT**.

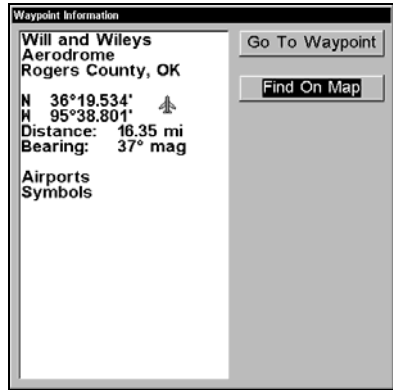
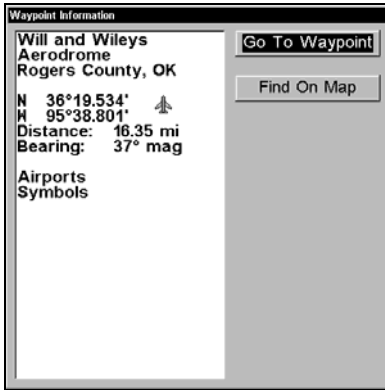

Go To Waypoint highlighted (left). Find on Map selected (right).

## Find Streets or Intersections

### Find a Street

1. From the Map Page, press **MENU** | ↓ to **FIND STREETS** | **ENT** and the Find Streets Menu appears.

2. You must first fill in a street name in the First Street dialog box. Press **ENT** to display the Find By Name menu. There are two options:  
**A.** You can spell out the street in the top selection box. Press ↑ or ↓ to change the first letter, then press → to move the cursor to the next letter and repeat until the name is correct, then press **ENT** | **ENT**.  
**B.** Or you can jump down to the lower box and pick a street from the list. Press **ENT**, then press ↓ or ↑ to select a street from the list and press **ENT**.

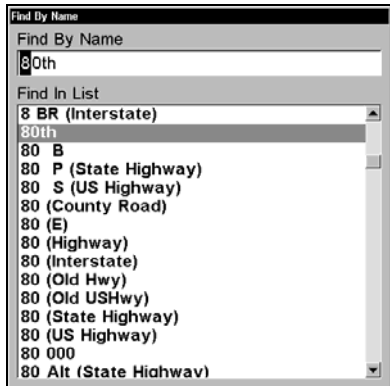
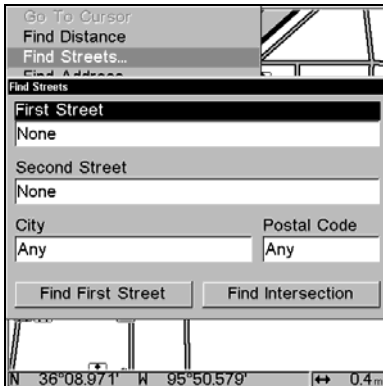

Find Streets menu (left). When finding a street by name (right), spell out the name in the top box or select it from the list in the lower box.

3. The Find Streets menu reappears with the street you're searching for in the First Street box. (In this example, it's 80th Street.) To search

for that street, press ↓ to **FIND FIRST STREET** | **ENT**. A message appears asking you to wait while the unit finds the street. When the Streets Found list appears, press ↑ or ↓ to select the street you are searching for and press **ENT**.

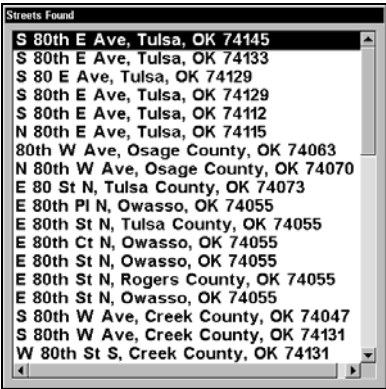
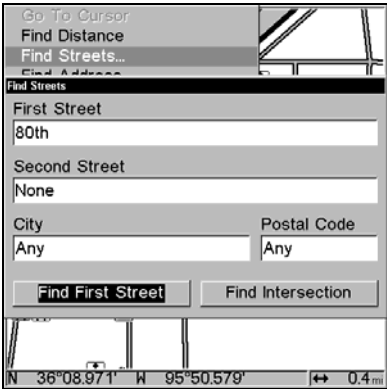

**Find Streets menu with the Find First street highlighted (left). Streets Found list (right).**

4. The Map Page appears, with the cursor pointing to the found street.

If you want to navigate to the found street at the cursor location, just press **MENU** | **ENT** | **EXIT**.

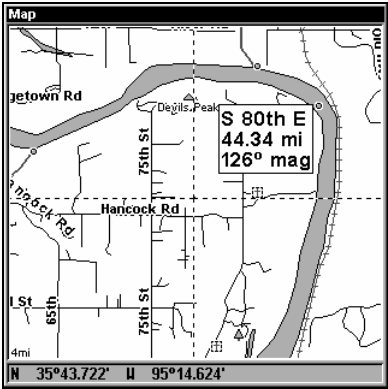

**Map Page showing results of a street search. The cursor points to the located street.**

**Find an Intersection**

You must enter one street in the First Street dialog box and enter the next street in the Second Street dialog box.

1. From the Map Page, press **MENU** | ↓ to **FIND STREETS** | **ENT** and the Find Streets Menu appears.

2. You must fill in a street name in the First Street dialog box. Press **ENT** to display the Find By Name menu. There are two options: **A.** You can spell out the street in the top selection box. Press **↑** or **↓** to change the first letter, then press **→** to move the cursor to the next letter and repeat until the name is correct, then press **ENT|ENT**. **B.** Or you can jump down to the lower box and pick a street from the list. Press **ENT**, then press **↓** or **↑** to select a street from the list and press **ENT**.

3. The Find Streets menu reappears with the street you're searching for in the First Street box. (In this example, it's 80th Street.)

4. Now fill in the second street. Press **↓** to **SECOND STREET|ENT** and the Find By Name menu appears again. Just like before, there are two options: **A.** You can spell out the second street in the top selection box. Press **↑** or **↓** to change the first letter, then press **→** to move the cursor to the next letter and repeat until the name is correct, then press **ENT|ENT**. **B.** You can also jump down to the lower box and pick the second street from the selection list. Press **ENT**, then press **↓** or **↑** to select a street from the list and press **ENT**.

5. The Find Streets menu reappears with the first and second street dialog boxes filled in. In this example, we selected 71st Avenue as our second street. You could now use similar techniques to select a city or Zip code, but your search will probably be faster if you leave those boxes blank. (You can specify a city and/or zip code when the search result list is too long.)

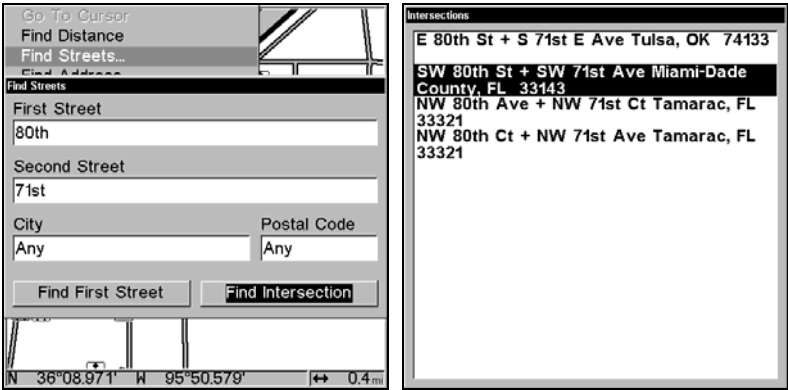

**Find Intersection command highlighted (left). Intersections Found list (right).**

6. To search for the intersection of the two streets, press **↓|→** to **FIND INTERSECTION|ENT**. A message appears asking you to wait while the unit finds the intersection. When the Intersections Found list appears, press



↑ or ↓ to select the intersection you are searching for and press **ENT**. (In our example, we selected the intersection of SW 80th Street and SW 71st Avenue in Miami, Fla.)

7. The Map Page appears, with the cursor pointing to the found intersection. The intersection in our example is shown in the following figure.

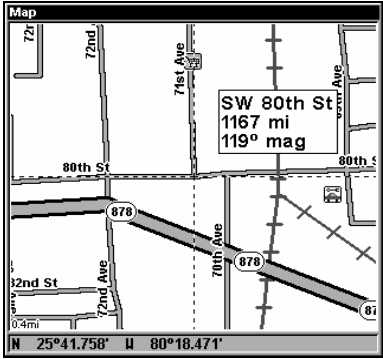

Map Page showing results of an intersection search. The cursor points to the located intersection.

If you want to navigate to the found intersection, just press **MENU | ENT | EXIT**.

### Find Waypoints

1. Press **WPT | ENT**.
2. If searching for the waypoint *By Name*, press **ENT**. If searching for the *Nearest* waypoint, press ↓ to **NEAREST|ENT**. (To search by name, jump to step 5.)

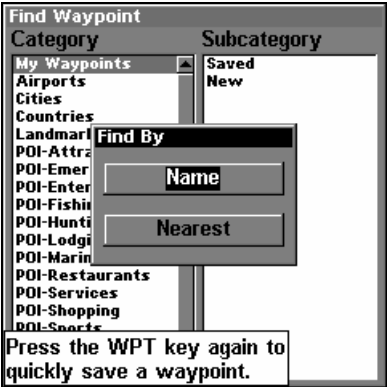
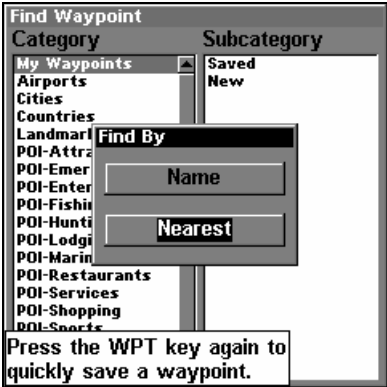

Find By Nearest command (left). Find by Name command (right).

3. If you're looking for nearest, the unit says it is calculating, then a list of waypoints appears. The closest waypoint is highlighted at the top of the list. The waypoint furthest from you is at the bottom of the list.

4. To see location information on the closest (highlighted) waypoint, press **ENT** and the Waypoint screen appears. (If you wanted to, you could select another waypoint from the list with the  $\uparrow$  or  $\downarrow$  keys.)

A. **To navigate** to the waypoint, press **ENT**. (The Go To Waypoint command is already highlighted.) The unit will show navigation information to the waypoint.

B. **To find** the waypoint, press  $\downarrow$  to **FIND ON MAP** | **ENT**. The Map Page appears with the cursor highlighting the found waypoint.

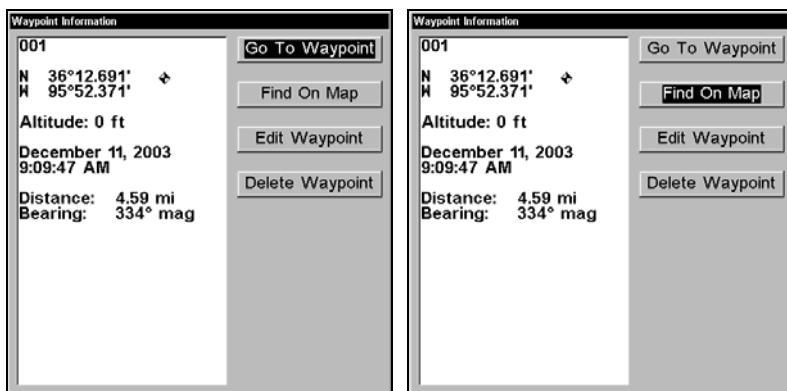

Waypoint Information screens with Go To Waypoint selected (left) and Find on Map selected (right).

To return to the previous page, press **EXIT** repeatedly.

5. If you're looking by name, there are two options: **A.** You can spell out the name in the top selection box. Press  $\uparrow$  or  $\downarrow$  to change the first letter, then press  $\rightarrow$  to move the cursor to the next letter and repeat until the name is correct, then press **ENT** | **ENT**. **B.** Or you can jump down to the lower selection list by pressing **ENT**, then press  $\downarrow$  or  $\uparrow$  to select a waypoint from the list, then press **ENT**. The waypoint screen appears.



Find By Name menu (left). Waypoint Information screen (center). The found waypoint is highlighted by the cursor on the Map Page (right).

- A. **To navigate** to the waypoint, press **ENT**. (Go To Waypoint command is already highlighted.) The unit will show navigation information to the waypoint.
- B. **To find** the waypoint, press ↓ to **FIND ON MAP** | **ENT**. The Map Page appears with the cursor highlighting the found waypoint.

# Notes

# Section 10: NMEA 2000

## NMEA 2000 Menu

The NMEA 2000 menu on your display unit's main menu allows you to configure, calibrate and monitor devices on a NMEA 2000 network. The NMEA 2000 menu provides access to the Bus Setup, Fuel Management and NMEA 2000 Alarms. You also can turn on/off Waypoint Sharing and Backlight Synchronization from the NMEA 2000 menu.

### NOTE:

Your internal GPS receiver is a non-network device, so data from the receiver CAN NOT be transmitted across a NMEA 2000 network.

## Internal GPS Receiver

GPS data from your internal GPS receiver can not be transmitted across the network to other network devices. The only way to transmit GPS data across the network is to add a LGC-2000 or LGC-3000 module to the LowranceNET.

### To switch from internal GPS to LGC module

Press **MENU**, select **NMEA 2000** and press **ENT**. Choose **BUSS SETUP** and press **ENT**.



**LGC-2000 highlighted on Buss Setup menu (left). LGC-2000 Device Configuration menu with the Set Active checkbox selected (center). LGC-2000 is now listed as Active on the Buss Setup menu (right).**

1. From the Buss Configuration list, select the LGC module and press **ENT**.
2. Press ↓ to Set Active and press **ENT**. The LGC module is now the active antenna for your unit. The Internal GPS antenna was automatically disabled when the LGC module was set to active.

**NOTE:**

To switch back to the internal GPS antenna, repeat the steps above. The internal GPS will be automatically enabled when you turn off (uncheck) the LGC module Set Active box.

**Bus Setup**

Selecting Bus Setup from the NMEA 2000 menu gives you access to the Bus Configuration menu and the NMEA Diagnostics and Ethernet Diagnostics pages. The Bus Configuration menu allows you to choose an engine-tank configuration and manage devices on the network. When the Bus Configuration menu is accessed, a list will appear of all NMEA 2000 devices on the network.

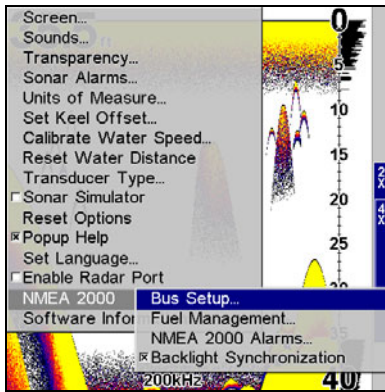

**Bus Setup highlighted on the NMEA 2000 menu.**

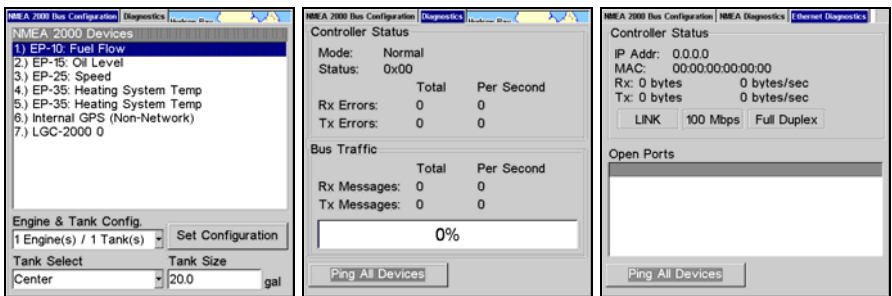

**Bus Configuration menu (left). NMEA Diagnostics page (center). Ethernet Diagnostics (right)**

The NMEA Diagnostics page displays information about the performance of the network bus, keeping you updated on bus status, mode, errors and bus traffic.

The Ethernet Diagnostics page keeps you updated on the performance of an Ethernet connection (if applicable) supplying information ranging

from IP Address to upload and download rates (bytes per second). To refresh either Diagnostics page, highlight the **PING ALL DEVICES** button at the bottom of the page and press **ENT**.

The network devices list is located in the top half of the Bus Configuration menu. You can configure, calibrate and set alarms for devices accessed from the Bus Configuration menu network devices list.

The Engine-Tank Configuration and Tank Select menus as well as the Tank Size dialog box are located on the bottom half of the Bus Configuration menu. The Set Configuration button — positioned next to the engine-tank configuration menu — allows you to finalize a selected configuration.

**NOTE:**

If you have not used the LMF-200 or LMF-400 to choose an engine-tank configuration for your vessel, you must use your display unit to select a configuration.

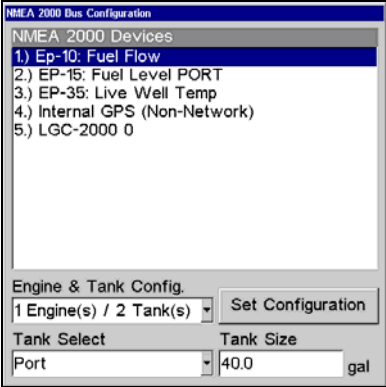

**Bus Configuration menu with list of network devices. Engine-Tank Configuration and Tank Select menus are at the bottom of the screen.**

**Engine & Tank Configuration**

The Engine-Tank configuration menu is located below the NMEA 2000 Devices list, but will only be accessible if a Suzuki engine Interface, EP-10 Fuel Flow, EP-15 Fluid Level, EP-45 Pressure Sensor or EP-50 Storage Device are on the network. When choosing an engine-tank configuration you will use the Tank Select menu, Tank Size dialog box and Set configuration button, all detailed below.

### Tank Select

The Tank Select menu allows you to choose from up to three tanks (Port, Center and Starboard), depending on the Engine-tank configuration that has been selected. This allows you to set up each tank individually.

### Tank Size

The Tank Size menu allows you to input the size of a selected tank in gallons. After selecting the desired tank from the Tank Select menu, you are ready to enter the tank's size.

### Set Configuration button

The Set Configuration button is used to finalize engine-tank configuration settings.

### Setting Engine-Tank Configuration:

1. Press **MENU|MENU**, use  $\downarrow$   $\uparrow$  to highlight **NMEA 2000** and press **ENT**.
2. The NMEA 2000 menu will appear with five options: Bus Setup, Fuel Management, NMEA 2000 Alarms, Waypoint Sharing and Backlight Synchronization. Choose **BUS SETUP** and press **ENT**.
3. Select **ENGINE & TANK CONFIG** and press **ENT**, which will open the Engine & Tank Configuration menu with the following configuration options: 1 Engine/1 Tank, 1 Engine/2 Tanks, 2 Engines/1 Tank, 2 Engines/2 Tanks, 3 Engines/1 Tank, 3 Engine/3 Tanks and Unconfigured Bus.

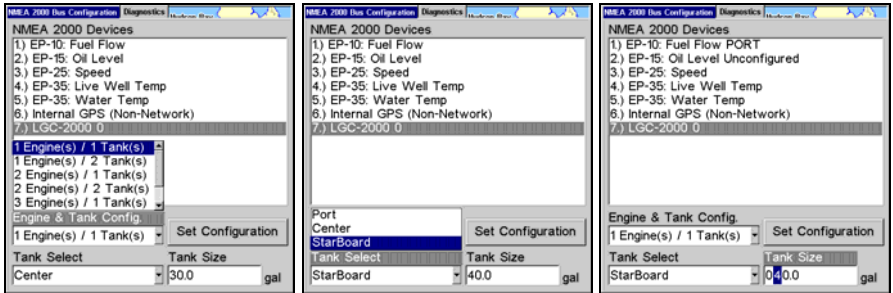

**1 Engine/1Tank highlighted on Engine and Tank Configuration menu (left). Starboard highlighted on Tank Select menu (center).**

**Tank Size set to 40 gallons (right).**

4. Choose the configuration that matches the number of engines and tanks on your vessel and press **ENT**.
5. Highlight **TANK SELECT** and press **ENT**, which will open the Tank Select menu.
6. Select the tank you want to set up and press **ENT**. Press  $\rightarrow$  to highlight the Tank Size dialog box and press **ENT**.



- 7. Use ↓ ↑, ← → to input the capacity (gallons) of the tank you chose from the Tank Select menu and press **ENT**.
- 8. Repeat Steps 5-7 for each remaining tank.
- 9. When all tanks have been configured, press the **SET CONFIGURATION** button. The following confirmation message will appear: *Are you sure you wish to change the bus configuration?* Choose **YES** and press **ENT**, Press **EXIT** to get back to the main display.

**Device Configuration Menu**

When a device is selected from the network devices list on the Bus Configuration menu, its Device Configuration menu will appear. Device configuration menus vary among devices. Available functions on device configuration menus allow you to change device names, tank sizes, fluid types and provide access to the Advanced Options menu. We will cover configuration and calibration later in this section.

**Device Information and Device Data**

The Device information panel, located to the left of the Device Configuration menu, displays information on the selected device that includes, software version, model, address, serial number, instance and current status.

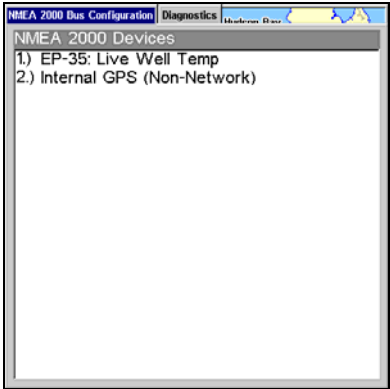

**If you do not have an EP-15 Fluid Level, EP-10 Fuel Flow or EP-20 Engine Interface on the network, the Bus Configuration menu will not display the Engine-Tank Configuration menu, Tank Select menu, Tank Size menu or Set Configuration button.**

Device Data is shown in the Device Data window at the bottom of the device configuration menu. The information displayed in the Device Data window will vary among devices. If, for example, you are viewing the device configuration menu for an EP-15 Fluid Level, the device data window will include tank size and the amount of fuel left in the tank.

The Device Data for an EP-10 Fuel Flow includes Fuel Rate (amount of fuel burned per hour), Fuel Used, Trip Fuel Used and Seasonal Fuel Used.

**NOTE:**

If, as in the graphic above, you do not have a Suzuki Engine Interface, EP-15 Fluid Level or EP-10 Fuel Flow on the network, the Engine & Configuration menu, Tank Select menu, Tank Size dialog and Set Configuration button will not be displayed on the Bus Configuration menu.

## Fuel Management Menu

The Fuel Management menu gives you access to the following options: Tank Location, Fuel Added, Add Fuel, Fill Tank, Engine Select, Reset Calibration, Reset Trip and Reset Seasonal. Those options allow you to configure, calibrate, reset calibration, reset trip fuel and reset seasonal fuel for select NMEA 2000 devices. We will cover configuration and calibration procedures later in this section.

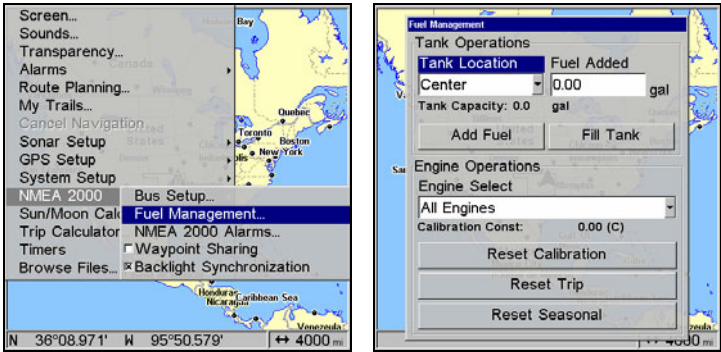

Fuel Management highlighted on the NMEA 2000 menu (left).  
Fuel Management menu (right).

### Tank Location

If you chose an engine-tank configuration with more than one tank, you will be able to switch the tank location (configuration) in the Tank Location menu. When fuel is added to a tank, you will select the correct tank from the Tank Location menu, then input the amount of fuel added in the Fuel Added dialog box.

### Fuel Added

Used in tandem with the Add Fuel command, the Fuel Added dialog box allows you to input the amount of fuel added to the tank, when an amount of fuel is added that does not fill up the tank.

### Add Fuel

After entering the amount of fuel added to a tank in the Fuel Added dialog, the Add Fuel command finalizes the entry of the data. Like the Fuel Added dialog, the Add Fuel command will only be used when an amount of fuel is added that does not fill up the tank.

### Fill Tank

You will use the Fill Tank command when calibrating a fuel flow and when filling up the tank without calibration.

### Adding Fuel to Tank

Tank Location, Fuel Added and Add Fuel commands work together to keep NMEA 2000 fuel data consistent with the actual amount of fuel added to the fuel tank(s).

1. Press **MENU | MENU**, select **NMEA 2000** and press **ENT**.
2. The NMEA 2000 menu will appear with five options: Bus Setup, Fuel Management, NMEA 2000 Alarms, Waypoint Sharing and Backlight Synchronization. Select **FUEL MANAGEMENT** and press **ENT**.
3. Highlight **TANK LOCATION** and press **ENT**. The Tank Location menu will appear with up to three options: Port, Center and Starboard.
4. Select the tank you added fuel to and press **ENT**.
5. Follow the steps below that apply to your tank.

#### If you filled up the tank:

**A.** Press the **FILL TANK** button and press **ENT**. The following message will appear: *Are you sure you wish to Fill Tank?* Press **ENT**. Another message will appear: *Do you wish to re-calibrate the device?* Highlight **No** and press **ENT**.

#### If you did not fill up the tank:

**B.** Highlight **FUEL ADDED** and press **ENT** to access the **FUEL ADDED** dialog box. Use **↑ ↓ , ← →** to input the amount of fuel added to the tank and press **ENT**. Select the **ADD FUEL** button and press **ENT**. The following message will appear: *Are you sure you wish to Add Fuel?* Highlight **YES** and press **ENT**.

6. Press **EXIT** repeatedly to get back to the main display.

### Engine Operations

The lower half of the Fuel Management menu contains the following Engine Operation functions: Engine Select, Reset Calibration, Reset Trip and Reset Seasonal.

#### Engine Select

Engine Select allows you to choose the desired engine when resetting calibration, resetting trip fuel and resetting seasonal fuel.

### To Reset Calibration:

Choosing the Reset Calibration command will switch fuel flow calibration settings back to factory defaults.

1. Press **MENU | MENU**, select **NMEA 2000** and press **ENT**.
2. Highlight **FUEL MANAGEMENT** and press **ENT**. The Fuel Management menu will appear.
3. Highlight to **ENGINE SELECT** and press **ENT**. Select the desired engine — the engine attached to the desired fuel flow — and press **ENT**.
4. Highlight **RESET CALIBRATION** and press **ENT**. The following confirmation message will appear: *Are you sure you wish to Reset Calibration?* Select **YES** and press **ENT**. Calibration settings for the selected fuel have been returned to factory defaults.

### To Reset Trip:

The Reset Trip function allows you to reset to zero the running total of fuel used on a particular trip.

1. Press **MENU | MENU**, select **NMEA 2000** and press **ENT**.
2. Highlight **FUEL MANAGEMENT** and press **ENT**. The Fuel Management menu will appear.
3. Select **RESET TRIP** and press **ENT**. The following confirmation message will appear: *Are you sure you wish to Reset Trip?* Highlight **YES** and press **ENT**. The Trip Fuel Used figure has been reset to zero.

### To Reset Seasonal:

Your unit can track fuel usage not only for trips, but also for entire seasons. The reset seasonal command allows you to reset to zero the running total of fuel used during a season.

1. Press **MENU | MENU**, select **NMEA 2000** and press **ENT**.
2. Highlight **FUEL MANAGEMENT** and press **ENT**. The Fuel Management menu will appear.
3. Select **RESET SEASONAL** and press **ENT**. The following confirmation message will appear: *Are you sure you wish to Reset Seasonal?* Highlight **YES** and press **ENT**. The Seasonal Fuel Used figure has been reset to zero.

## NMEA 2000 Alarms

The NMEA 2000 Alarms menu allows you to set Full and Empty fuel alarms for the EP-10 Fuel Flow, EP-15 Fluid Level, EP-50 Storage Device and the Suzuki Engine Interface. The alarms may be set to a percentage (0-100%) of tank capacity.

The second tab at the top of the NMEA 2000 Alarms page is the Alarm Status Tab. When an alarm has been set for a device, the alarm and its current status will be shown on the Alarm Status window. To view the Alarm Status window, highlight the Alarm Status tab and press **ENT**.

**To set NMEA 2000 Alarm:**

1. Press **MENU | MENU**, select **NMEA 2000** and press **ENT**.
2. Highlight **NMEA 2000 ALARMS** and press **ENT**.
3. Highlight **FLUID LEVEL DEVICE** and press **ENT**. Use **↑ ↓** to select the device you want to set an alarm for and press **ENT**.
4. Highlight the **ENABLED** box next to the desired alarm (Full Alarm or Empty Alarm) and press **ENT** to turn on the alarm.
5. To set the alarm percentage, press **→** to highlight **PERCENT** and press **ENT**.
6. Use **↑ ↓, ← →** to input the desired percentage and press **ENT**. Repeat Steps 3-4 to set the other alarm.
7. Highlight **SET CONFIGURATION** and press **ENT** to finalize alarm settings. Press **EXIT** repeatedly to get back to the main display.

**NOTE:**

To turn off (uncheck) an alarm, highlight its **ENABLED BOX** and press **ENTER**.

## Waypoint Sharing

Waypoint Sharing allows you to share a waypoint from one display unit with display units across the network.

**To turn on/off Waypoint Sharing:**

1. Press **MENU | MENU**, select **NMEA 2000** and press **ENT**.
2. Highlight **WAYPOINT SHARING** and press **ENT** which will turn on/off waypoint sharing.
3. Press **EXIT** repeatedly to get return to the main display.

## Backlight Synchronization

The Backlight Synchronization command will keep all display unit backlight levels consistent across the NMEA 2000 network. So, if you set the backlight level to 75% on one display unit, all other units on the network will automatically switch to the same setting.

### To turn on/off Backlight Synchronization:

1. Press **MENU | MENU**, select **NMEA 2000** and press **ENT**.
2. Highlight **BACKLIGHT SYNCHRONIZATION** and press **ENT**, which will turn on/off Backlight Synchronization.
3. Press **EXIT** repeatedly to get back to the main display.

## Configuring EP Sensors

All configurable devices are configured through their Device Configuration menus, which may be accessed through the network devices list on the Bus Configuration menu.

### EP-35 Temperature Configuration

#### To input Device Name:

1. Press **MENU | MENU**, use **↑ ↓** to select **NMEA 2000** and press **ENT**. The NMEA 2000 menu will appear with five options: Bus Setup, Fuel Management, NMEA 2000 Alarms, Waypoint Sharing and Backlight Synchronization.
2. Highlight **BUS SETUP** and press **ENT**, which will open the Bus Configuration menu. A list of network devices will be at the top of the page.
3. Select the temp sensor you want to rename and press **ENT**. The Device Configuration menu will appear with the Device Name dialog box highlighted.
4. Press **ENT** and use **↑ ↓, ← →** to input the desired name for the temp sensor. Press **ENT**. Press **EXIT** repeatedly to get back to the main display.

#### To select Temp Type:

1. Press **MENU | MENU**, use **↑ ↓** to select **NMEA 2000** and press **ENT**. The NMEA 2000 menu will appear with five options: Bus Setup, Fuel Management, NMEA 2000 Alarms, Waypoint Sharing and Backlight Synchronization.
2. Highlight **BUS SETUP** and press **ENT**, which will open the Bus Configuration menu. A list of network devices will be at the top of the page.
3. Select the desired temp sensor and press **ENT**. The Device Configuration menu will appear.
4. Highlight **TEMP TYPE** and press **ENT**. The following list of Temp Types will appear: Water, Outside, Inside, Engine Room, Cabin, Live Well, Bait Well, Refrigeration, Heating System and Unknown.
5. Highlight the desired Temp Type and press **ENT**. The following confirmation message will appear: *Are you sure you wish to change this device's configuration?*
6. Highlight **YES** and press **ENT**. Press **EXIT** repeatedly to get back to the main display.

## Advanced Options menu

The Temp sensor Advanced Options menu contains two categories: Instance and Restore Defaults.

### Instance

The Instance command is intended for use *only* by experienced NMEA 2000 network technicians. Instance allows network technicians to resolve certain electronic probe conflicts. This is most likely to occur if the network includes LMF-200 or LMF-400 digital gauges, which support the display of fewer electronic probes than your GPS or sonar/GPS unit. If you want to use your unit in a network including one of these digital gauges, you may need to consult customer service.

You should never need this command if you are connecting your unit to a network with similar display units and/or a series of electronic probes.

### Restore Defaults

The Restore Defaults command allows you to reset an individual EP-35 Temp Sensor's settings to factory defaults. If, for example, you execute the Restore Defaults command from your Water Temp's Advanced Options menu, only the settings for the Water Temp will be reset to factory defaults. Other temps on the network will not be affected.

#### To restore default settings:

1. Press **MENU|MENU**, use  $\uparrow \downarrow$  to select **NMEA 2000** and press **ENT**. The NMEA 2000 menu will appear with five options: Bus Setup, Fuel Management, NMEA 2000 Alarms, Waypoint Sharing and Backlight Synchronization.
2. Highlight **BUS SETUP** and press **ENT**, which will open the Bus Configuration menu. A list of network devices will be at the top of the page.
3. Select the desired temp sensor and press **ENT**. The Device Configuration menu will appear.
4. Highlight **ADVANCED OPTIONS** and press **ENT**.
5. Select **RESTORE DEFAULTS** and press **ENT**. The following message will appear: *Are you sure you wish to change this device's configuration?*
6. Highlight **YES** and press **ENT**. Press **EXIT** repeatedly to get back to the main display.

## EP-10 Fuel Flow Configuration

### To input Device Name:

1. Press **MENU|MENU**, use  $\uparrow \downarrow$  to select **NMEA 2000** and press **ENT**. The NMEA 2000 menu will appear with five options: Bus Setup, Fuel Management, NMEA 2000 Alarms, Waypoint Sharing and Backlight Synchronization.

2. Highlight **BUS SETUP** and press **ENT**, which will open the Bus Configuration menu. A list of network devices will be at the top of the page.
3. Select the fuel flow you want to rename and press **ENT**. The Device Configuration menu will appear with the Device Name dialog box highlighted.
4. Press **ENTER** and use  $\uparrow \downarrow$ ,  $\leftarrow \rightarrow$  to input the desired name for the fuel flow. Press **ENT**. Press **EXIT** repeatedly to get back to the main display.

#### **To select a Location:**

1. Press **MENU| MENU**, use  $\uparrow \downarrow$  to select **NMEA 2000** and press **ENT**. The NMEA 2000 menu will appear with five options: Bus Setup, Fuel Management, NMEA 2000 Alarms, Waypoint Sharing and Backlight Synchronization.
2. Highlight **BUS SETUP** and press **ENT**, which will open the Bus Configuration menu. A list of network devices will be at the top of the page.
3. Select the desired fuel flow and press **ENT**. The Device Configuration menu will appear.
4. Select **LOCATION** and press **ENT**, which will open the Location menu with following options: Port, Center, Starboard and Unknown.
5. Highlight the desired location and press **ENT**. The following message will appear: *Are you sure you wish to change this device's configuration?*
5. Select **Yes** and press **ENT**. Press **EXIT** repeatedly to get back to the main display.

#### **Advanced Options menu**

The Fuel Flow sensor Advanced Options menu contains two categories: Instance and Restore Defaults.

##### **Instance**

The Instance command is intended for use *only* by experienced NMEA 2000 network technicians. Instance allows network technicians to resolve certain electronic probe conflicts. This is most likely to occur if the network includes LMF-200 or LMF-400 digital gauges, which support the display of fewer electronic probes than your GPS or sonar/GPS unit. If you want to use your unit in a network including one of these digital gauges, you may need to consult customer service.

You should never need this command if you are connecting your unit to a network with similar display units and/or a series of electronic probes.

##### **Restore Defaults**

The Restore Defaults command allows you to reset an individual EP-10 Fuel Flow Sensor's settings to factory defaults. If, for example, you execute the Restore Defaults command from your Port Fuel Flow Ad-



vanced Options menu, only the settings for the Port Fuel Flow will be reset to factory defaults. Other fuel flows on the network will not be affected.

**To restore default settings:**

1. Press **MENU|MENU**, use  $\uparrow\downarrow$  to select **NMEA 2000** and press **ENT**. The NMEA 2000 menu will appear with five options: Bus Setup, Fuel Management, NMEA 2000 Alarms, Waypoint Sharing and Backlight Synchronization.
2. Highlight **BUS SETUP** and press **ENT**, which will open the Bus Configuration menu. A list of network devices will be at the top of the page.
3. Use  $\uparrow\downarrow$  to select the desired fuel flow and press **ENT**. The Device Configuration menu will appear.
4. Highlight **ADVANCED OPTIONS** and press **ENT**.
5. Select **RESTORE DEFAULTS** and press **ENT**. The following message will appear: *Are you sure you wish to change this device's configuration?*
6. Highlight **YES** and press **ENT**. Press **EXIT** repeatedly to get back to the main display.

**EP-15 Fluid Level Configuration**

**To input Device Name:**

1. Press **MENU|MENU**, use  $\uparrow\downarrow$  to select **NMEA 2000** and press **ENT**. The NMEA 2000 menu will appear with five options: Bus Setup, Fuel Management, NMEA 2000 Alarms, Waypoint Sharing and Backlight Synchronization.
2. Highlight **BUS SETUP** and press **ENT**, which will open the Bus Configuration menu. A list of network devices will be at the top of the page.
3. Select a fluid level you want to rename and press **ENT**. The Device Configuration menu will appear with the Device Name dialog box highlighted.
4. Press **ENT** and use  $\uparrow\downarrow, \leftarrow \rightarrow$  to input the desired name for the fluid level. Press **ENTER**. Press **EXIT** repeatedly to get back to the main display.

**To select Tank Instance (Location):**

1. Press **MENU|MENU**, use  $\uparrow\downarrow$  to select **NMEA 2000** and press **ENT**. The NMEA 2000 menu will appear with five options: Bus Setup, Fuel Management, NMEA 2000 Alarms, Waypoint Sharing and Backlight Synchronization.
2. Highlight **BUS SETUP** and press **ENT**, which will open the Bus Configuration menu. A list of network devices will be at the top of the page.
3. Select the desired fluid level and press **ENT**. The Device Configuration menu will appear.

4. Highlight **TANK INSTANCE** and press **ENT**, which will open the Tank Instance menu with the following options: Tank 1, Tank 2, Tank 3 and Unknown.

5. Select the desired Tank Instance (location) and press **ENT**. The following confirmation message will appear: *Are you sure you wish to change this device's configuration?*

6. Highlight **Yes** and press **ENT**. Press **EXIT** repeatedly to get back to the main display.

#### **To select Fluid Type:**

1. Press **MENU| MENU**, use **↑ ↓** to select **NMEA 2000** and press **ENT**. The NMEA 2000 menu will appear with five options: Bus Setup, Fuel Management, NMEA 2000 Alarms, Waypoint Sharing and Backlight Synchronization.

2. Highlight **BUS SETUP** and press **ENT**, which will open the Bus Configuration menu. A list of network devices will be at the top of the page.

3. Select the desired fluid level and press **ENT**. The Fluid Level Device Configuration menu will appear.

4. Press **↓** to **FLUID TYPE** and press **ENT**, which will open the Fluid Type menu with the following options: Fuel, Water, Gray Water, Live Well, Oil, Black Water and Unknown.

5. Select the desired fluid type and press **ENT**. The following message will appear: *Are you sure you wish to change this device's configuration?*

6. Highlight **Yes** and press **ENT**. Press **EXIT** repeatedly to get back to the main display.

#### **To input Tank Size:**

1. Press **MENU| MENU**, use **↑ ↓** to select **NMEA 2000** and press **ENT**. The NMEA 2000 menu will appear with five options: Bus Setup, Fuel Management, NMEA 2000 Alarms, Waypoint Sharing and Backlight Synchronization.

2. Highlight **BUS SETUP** and press **ENT**, which will open the Bus Configuration menu. A list of network devices will be at the top of the page.

3. Select the desired fluid level and press **ENT**. The Fluid Level Device Configuration menu will appear.

4. Highlight **TANK SIZE** and press **ENT**. Use **↑ ↓ , ← →** to input the size of the tank and press Enter. The following message will appear: *Are you sure you wish to change this device's configuration?*

5. Select **Yes** and press **ENT**. Press **EXIT** repeatedly to get back to the main display.

## Advanced Options menu

The Fuel Flow sensor Advanced Options menu contains two categories: Instance and Restore Defaults.

### Instance

The Instance command is intended for use *only* by experienced NMEA 2000 network technicians. Instance allows network technicians to resolve certain electronic probe conflicts. This is most likely to occur if the network includes LMF-200 or LMF-400 digital gauges, which support the display of fewer electronic probes than your GPS or sonar/GPS unit. If you want to use your unit in a network including one of these digital gauges, you may need to consult customer service.

You should never need this command if you are connecting your unit to a network with similar display units and/or a series of electronic probes.

### Restore Defaults

The Restore Defaults command allows you to reset an individual EP-15 Fluid Level Sensor's settings to factory defaults. If, for example, you execute the Restore Defaults command from your Gray Water Fluid Level Advanced Options menu, only the settings for the Gray Water Fluid Level will be reset to factory defaults. Other fluid levels on the network will not be affected.

#### To restore default settings:

1. Press **MENU| MENU**, use  $\uparrow \downarrow$  to select **NMEA 2000** and press **ENT**. The NMEA 2000 menu will appear with five options: Bus Setup, Fuel Management, NMEA 2000 Alarms, Waypoint Sharing and Backlight Synchronization.
2. Highlight **BUS SETUP** and press **ENT**, which will open the Bus Configuration menu. A list of network devices will be at the top of the page.
3. Select the desired fluid level and press **ENT**. The Device Configuration menu will appear.
4. Highlight **ADVANCED OPTIONS** and press **ENT**.
5. Select **RESTORE DEFAULTS** and press **ENT**. The following message will appear: *Are you sure you wish to change this device's configuration?*
6. Highlight **YES** and press **ENT**. Press **EXIT** repeatedly to get back to the main display.

#### NOTE:

The Fluid Level Device Configuration menu also contains the Calibrate button, but we will address that later in the segment covering Calibration.

## Suzuki Engine Interface Configuration

### To input Device Name:

1. Press **MENU|MENU**, use  $\uparrow \downarrow$  to select **NMEA 2000** and press **ENT**. The NMEA 2000 menu will appear with five options: Bus Setup, Fuel Management, NMEA 2000 Alarms, Waypoint Sharing and Backlight Synchronization.
2. Highlight **BUS SETUP** and press **ENT**, which will open the Bus Configuration menu. A list of network devices will be at the top of the page.
3. Use  $\uparrow \downarrow$  to select the engine interface you want to rename and press **ENT**. The Device Configuration menu will appear with the Device Name dialog box highlighted.
4. Press **ENT** and use  $\uparrow \downarrow, \leftarrow \rightarrow$  to input a name for the interface. Press **ENT**. Press **EXIT** repeatedly to return to the main display.

### To select a Location:

1. Press **MENU|MENU**, use  $\uparrow \downarrow$  to select **NMEA 2000** and press **ENT**. The NMEA 2000 menu will appear with five options: Bus Setup, Fuel Management, NMEA 2000 Alarms, Waypoint Sharing and Backlight Synchronization.
2. Highlight **BUS SETUP** and press **ENT**, which will open the Bus Configuration menu. A list of network devices will be at the top of the page.
3. Select the desired engine interface and press **ENT**. The Device Configuration menu will appear.
4. Highlight **LOCATION** and press **ENT**, which will open the Location menu with the following options: Port, Center, Starboard and Unknown.
5. Select the desired location and press **ENT**. The following confirmation message will appear: *Are you sure you wish to change this device's configuration?*
6. Press **ENT**. Press **EXIT** repeatedly to get back to the main display.

### To select Engine Type:

1. Press **MENU|MENU**, use  $\uparrow \downarrow$  to select **NMEA 2000** and press **ENT**. The NMEA 2000 menu will appear with five options: Bus Setup, Fuel Management, NMEA 2000 Alarms, Waypoint Sharing and Backlight Synchronization.
2. Highlight **BUS SETUP** and press **ENT**, which will open the Bus Configuration menu. A list of network devices will be at the top of the page.
3. Use  $\uparrow \downarrow$  to select the desired engine interface and press **ENT**. The Device Configuration menu will appear.
4. Highlight **ENGINE TYPE** and press **ENT**, which will open the Engine Type menu with the following options: DF40, DF50, DF60, DF70, DF90/115, DF140, DF150, DF175, DF200/225, DF250 and DF300.

5. Select your engine type and press **ENT**. The following message will appear: *Are you sure you wish to change this device's configuration?*
6. Highlight **YES** and press **ENT**. Press **EXIT** repeatedly to get back to the main display.

### **Advanced Options menu**

The Engine Interface Advanced Options menu contains three categories: Instance, Restore Defaults and Reset Trim Calibration.

#### **Instance**

The Instance command is intended for use *only* by experienced NMEA 2000 network technicians. Instance allows network technicians to resolve certain electronic probe conflicts. This is most likely to occur if the network includes LMF-200 or LMF-400 digital gauges, which support the display of fewer electronic probes than your GPS or sonar/GPS unit. If you want to use your unit in a network including one of these digital gauges, you may need to consult customer service. You should never need this command if you are connecting your unit to a network with similar display units and/or a series of electronic probes.

#### **Restore Defaults**

The Restore Defaults command allows you to reset an individual engine interface's settings to factory defaults. If, for example, you execute the Restore Defaults command from your Port Engine Interface Advanced Options menu, only the settings for the Port Engine Interface will be reset to factory defaults. Other engine interfaces on the network will not be affected.

#### **To restore default settings:**

1. Press **MENU|MENU**, use **↑↓** to select **NMEA 2000** and press **ENT**. The NMEA 2000 menu will appear with five options: Bus Setup, Fuel Management, NMEA 2000 Alarms, Waypoint Sharing and Backlight Synchronization.
2. Highlight **BUS SETUP** and press **ENT**.
3. Use **↑↓** to select the desired fluid level and press **ENT**. The Device Configuration menu will appear.
4. Highlight **ADVANCED OPTIONS** and press **ENT**.
5. Select **RESTORE DEFAULTS** and press **ENT**. The following message will appear: *Are you sure you wish to change this device's configuration?*
6. Highlight **YES** and press **ENT**. Press **EXIT** repeatedly to get back to the main display.

## NOTE:

The Suzuki Engine Interface Device Configuration menu contains two Engine Trim calibration commands, which will be addressed in the next segment of this section, Calibrating EP Sensors.

## Calibrating EP Sensors

The factory calibration settings for the EP-10 Fuel Flow, EP-15 Fluid Level and Suzuki Engine Interface should be adequate for the majority of applications, so calibration will not be necessary in most cases.

### EP-10 Fuel Flow Calibration

The default calibration for the EP-10 Fuel Flow is adequate in most cases, but if Fuel Used readings are off by more than 3 percent, calibration is recommended.

#### To check fuel flow accuracy:

Select Fuel Used to be shown as Overlay Data on your unit's main display. Refer to the Overlay Data segment of this manual for instructions on how to select Fuel Used data as Overlay Data.

1. After selecting Fuel Used as overlay data, fill up your tank and press **MENU | MENU**.
2. Select **NMEA 2000** and press **ENT**.
3. Highlight **FUEL MANAGEMENT** and press **ENT**. Select **TANK LOCATION** and press **ENT**.
4. Use **↑ ↓** to select the location (Port, Center or Starboard) of the fuel flow you want to calibrate and press **ENT**.
5. Highlight **FILL TANK** and press **ENT**. The following confirmation message will appear: *Are you sure you wish to Fill Tank?*
6. Select **Yes** and press **ENT**. The following confirmation message will appear: *Do you wish to re-calibrate the device?*
7. Highlight **No** and press **ENT**.
8. Take your vessel out on the water and burn at least five gallons of fuel. **Be sure you run only ONE engine — the engine connected to your fuel flow.**
9. Fill up your tank again, noting how much fuel you added to the tank. Compare that number to the Fuel Used figure displayed on the page you customized. If the amount of fuel you added to the tank and the fuel used figure are off by more than 3 percent, we recommend the fuel flow be calibrated.

## NOTE:

You must use the gauge's Fill Tank command when filling your fuel tank to keep the fuel flow updated with correct information on the amount of fuel in the tank.

### **To calibrate an EP-10 Fuel Flow:**

10. If calibration is necessary, press **MENU | MENU**, select **NMEA 2000** and press **ENT**.
11. Highlight **FUEL MANAGEMENT** and press **ENT**.
12. Select **TANK LOCATION** and press **ENT** to choose the location of the tank connected to selected fuel flow. Press **ENT**.
13. Highlight **FILL TANK** and press **ENT**. The following message will appear: *Are you sure you wish to Fill Tank?* Select **YES** and press **ENT**.
14. The following message will appear: *Do you wish to re-calibrate the device?* Select **YES** and press **ENT**.
15. Repeat these steps for each EP-10 Fuel Flow you want to calibrate.

### **To Reset Calibration:**

1. Press **MENU | MENU**, select **NMEA 2000** and press **ENT**.
2. Highlight **FUEL MANAGEMENT** and press **ENT**.
3. Highlight **ENGINE SELECT** and press **ENT**. The Engine Select menu will appear with up to four options: All Engines, Port, Center and Starboard. Selecting All Engines will reset calibration for all engines back to factory defaults.
4. Select All Engines or the engine connected to the desired device and press **ENT**.
5. Highlight **RESET CALIBRATION** and press **ENT**. The following message will appear: *Are you sure you wish to Reset Calibration?*
6. Highlight **YES** and press **ENT**. Press **EXIT** repeatedly to get back to the main display.

### **EP-15 Fluid Level Calibration**

The default calibration for the EP-15 Fluid Level is just as accurate as standard fluid level gauges. If, however, the tank has an irregular shape or greater accuracy is needed, calibration is recommended. There are three calibration options: 2-Point, 3-Point and 5-Point.

#### **2-Point Calibration**

A 2-point calibration is best suited for rectangular or square-shaped tanks, where the capacity of the top half of the tank matches the capacity in the lower half of the tank. In a two-point calibration, you will set two points, one each for empty and full levels. You can begin calibration at either of the two points, but we recommend starting with an empty tank. You will fill the tank to complete calibration.

1. Press **MENU | MENU**, use **↓ ↑** to select **NMEA 2000** and press **ENT**.
2. Highlight **BUS SETUP** and press **ENT**, which will open the Bus Configuration menu. A list of network devices will be at the top of the page.

3. Select the EP-15 Fluid Level and press **ENT**.
4. Press  $\downarrow$  to select **CALIBRATE** and press **ENT**. The Device Calibration menu will appear. Instructions on Calibration will be listed at the top of the menu.
5. Highlight **NUM Pts**, press **ENT** and select **2**. Press **ENT**.
6. Select **FLUID LEVEL**, press **ENT**, then select **EMPTY LEVEL** and press **ENT**.
7. Make sure the fuel tank is empty, highlight **CALIBRATE** and press **ENT**. The following message will appear: *Empty Level Calibration Completed*. Press **ENT**.
8. Fill up your tank, highlight **FLUID LEVEL** and press **ENT**.
9. Select **FULL LEVEL** and press **ENT**. Highlight **CALIBRATE** and press **ENT**.
10. The following message will appear: *Full level Calibration Completed*. Press **ENT**, then press **EXIT** repeatedly to get back to the main display.

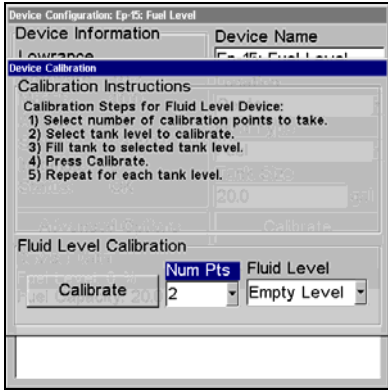

**Calibrate** is highlighted on the device configuration menu (left). Calibration menu (right) with calibration instructions listed at the top.

**3-Point Calibration**

3-point calibration is designed for tanks that vary in shape from the top to the bottom. You can begin calibration at any point in the 3-point process, but we recommend starting calibration with an empty tank.

In a 3-point calibration, you will set three points, one each for empty, half and full levels.

1. Press **MENU| MENU**, use  $\downarrow \uparrow$  to select **NMEA 2000** and press **ENT**.
2. Highlight **Bus SETUP** and press **ENT**, which will open the Bus Configuration menu. A list of network devices will be at the top of the page. 3. Select the EP-15 Fluid Level and press **ENT**.



4. Press **↓** to select **CALIBRATE** and press **ENT**. The Device Calibration menu will appear.
5. Highlight **NUM PTS**, press **ENT** and select **3**. Press **ENT**.
6. Make sure your tank is empty, then highlight **FLUID LEVEL** and press **ENT**. Select **EMPTY LEVEL** and press **ENT**.
7. Select **CALIBRATE** and press **ENT**. The following message will appear: *Empty Level Calibration Completed*. Press **ENTER**.
8. Add half a tank of fuel, highlight **FLUID LEVEL** and press **ENT**. Select **HALF LEVEL** and press **ENT**.
9. Select **CALIBRATE** and press **ENT**. The following message will appear: *Half Level Calibration Completed*. Press **ENT**.
10. Fill up the tank, then highlight **FLUID LEVEL** and press **ENT**. Select **FULL LEVEL** and press **ENT**.
11. Highlight **CALIBRATE** and press **ENT**. The following message will appear: *Full Level Calibration Completed*. Press **ENT**, then press **EXIT** repeatedly to get back to the main display.

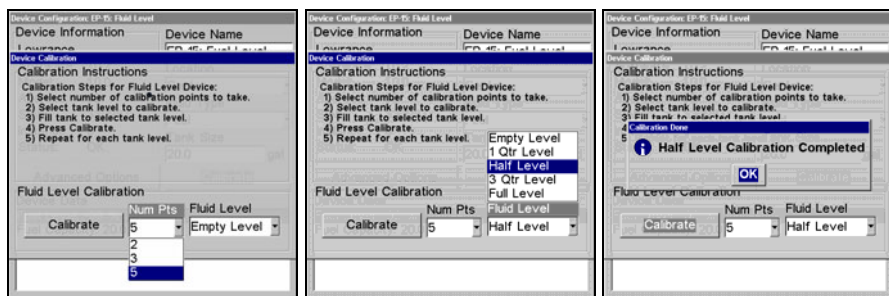

**Num Pts menu with 5-point calibration selected (left). Half level selected on Fluid Level menu (center). Calibration Done window (right).**

### 5-Point Calibration

5-point calibration is best suited tanks that vary greatly in shape from top to bottom. You can begin calibration at any point in the 5-point calibration process. We recommend starting calibration with an empty tank. In a five-point calibration you will set five points: Empty Level, 1 Qtr Level, Half Level, 3 Qtr Level and Full Level.

In a 5-point calibration, you will have four calibration points left after calibrating your tank's Empty Level. To figure out how much fuel you should add for the remaining steps of the calibration process, divide the total capacity of you tank by four. So, if you have a 40-gallon tank, each quarter tank will equate to 10 gallons.

1. Press **MENU|MENU**, use **↓↑** to select **NMEA 2000** and press **ENT**.
2. Highlight **BUS SETUP** and press **ENT**, which will open the Bus Configu-

ration menu. A list of network devices will be at the top of the page.

3. Select the desired EP-15 Fluid Level and press **ENT**.

4. Press ↓ to select **CALIBRATE** and press **ENT**. The Device Calibration menu will appear.

5. Highlight **NUM PTS**, press **ENT** and select **5**. Press **ENT**.

6. Make sure your tank is empty, then highlight **FLUID LEVEL** and press **ENT**. Select **EMPTY LEVEL** and press **ENT**.

7. Select **CALIBRATE** and press **ENT**. The following message will appear: *Empty Level Calibration Completed*. Press **ENT**.

8. Add 1 quarter tank of fuel, highlight **FLUID LEVEL** and press **ENT**. Select **1 QTR LEVEL** and press **ENT**.

9. Select **CALIBRATE** and press **ENT**. The following message will appear: *1 Qtr Level Calibration Completed*. Press **ENT**.

10. Add another quarter tank of fuel, which should raise the fuel level to half a tank. Highlight **FLUID LEVEL** and press **ENT**. Select **HALF LEVEL** and press **ENT**.

11. Highlight **CALIBRATE** and press **ENT**. The following message will appear: *Half Level Calibration Completed*. Press **ENT**.

12. Add another quarter tank of fuel, which should raise the fuel level to 3 quarters of a tank. Highlight **FLUID LEVEL** and press **ENT**. Select **3 QTR LEVEL** and press **ENT**.

13. Select **CALIBRATE** and press **ENT**. The following message will appear: *3 Qtr Level Calibration Completed*. Press **ENT**.

14. Top off the tank, highlight **FLUID LEVEL** and press **ENT**. Select **FULL LEVEL** and press **ENT**.

15. Select **CALIBRATE** and press **ENT**. The following message will appear: *Full Level Calibration Completed*. Press **ENT**, then press **EXIT** repeatedly to get back to the main display.

### **Fuel Flow Calibration in a Suzuki Engine Interface**

The default calibration for the Suzuki Engine Interface is adequate in most cases, but if Fuel Used readings are off by more than 3 percent, calibration is recommended.

#### **To check engine interface accuracy:**

Select Fuel Used to be shown as Overlay Data on your unit's main display. Refer to the Overlay Data segment of this manual for instructions on how to select Fuel Used data as Overlay Data.

1. After selecting Fuel Used as overlay data, fill up your tank and press **MENU | MENU**.

2. Select **NMEA 2000** and press **ENT**.

3. Highlight **FUEL MANAGEMENT** and press **ENT**. Select **TANK LOCATION** and press **ENT**.
4. Use **↑ ↓** to select the location (Port, Center or Starboard) of the engine interface you want to calibrate and press **ENT**.
5. Highlight **FILL TANK** and press **ENT**. The following confirmation message will appear: *Are you sure you wish to Fill Tank?*
6. Select **YES** and press **ENTER**. The following confirmation message will appear: *Do you wish to re-calibrate the device?*
7. Highlight **No** and press **ENT**. Take your vessel out on the water and burn at least five gallons of fuel. **Be sure you run only ONE engine — the engine connected to your engine interface.**
9. Fill up your tank again, noting how much fuel you added to the tank. Compare that number to the Fuel Used figure displayed on the page you customized. If the amount of fuel you added to the tank and the fuel used figure are off by more than 3 percent, we recommend the engine interface be calibrated.

#### **NOTE:**

You must use the gauge's Fill Tank command when filling your fuel tank to keep the engine interface updated with correct information on the amount of fuel in the tank.

#### **To calibrate a Suzuki Engine Interface:**

10. If calibration is necessary, press **MENU | MENU**, select **NMEA 2000** and press **ENT**.
11. Highlight **FUEL MANAGEMENT** and press **ENT**.
12. Select **TANK LOCATION** and press **ENT** to choose the location of the tank connected to the selected engine interface. Press **ENT**.
13. Highlight **FILL TANK** and press **ENT**. The following message will appear: *Are you sure you wish to Fill Tank?* Select **YES** and press **ENT**.
14. The following message will appear: *Do you wish to re-calibrate the device?* Select **YES** and press **ENT**.
15. Repeat these steps for each engine interface you want to calibrate.

#### **Engine Trim Calibration**

Engine Trim is calibrated through the Suzuki Engine Interface Device Configuration menu.

1. Press **MENU | MENU**, select **NMEA 2000** and press **ENT**.
2. Choose **BUS SETUP** and press **ENTER**. Select the Suzuki Engine Interface connected to the desired engine and press **ENT**.
3. Highlight **CALIBRATE TRIM** and press **ENT**. The Device Calibration window will appear with a list of Calibration Instructions.
4. Highlight **START CALIBRATION** and press **ENT**. The following message will appear: *Please fully raise the Engine Trim.*

5. After engine trim has been fully raised, press **ENT**. The following message will appear: *Please fully lower the Engine trim.*
6. After engine trim has been fully lowered, press **ENT**. A Calibration Completed message will appear. Press **ENT**.
7. Repeat these instructions to adjust the engine trim for each engine connected to a Suzuki Engine Interface. Press **EXIT** repeatedly to return to the main display.

### **Reset Trim Calibration**

If you are not satisfied with your engine trim calibration, you can reset engine trim calibration from the Suzuki Engine Interface Advanced Options menu.

1. Press **MENU | MENU**, select **NMEA 2000** and press **ENT**.
2. Choose **BUS SETUP** and press **ENT**. Select the Suzuki Engine Interface connected to the desired engine and press **ENT**.
3. Highlight **ADVANCED OPTIONS** and press **ENT**. Select Reset **TRIM CALIBRATION** and press **ENT**. The following message will appear: *Do you wish to re-calibrate the device?*
4. Highlight **Yes** and press **ENT**. Press **EXIT** repeatedly to get back to the main display.

### **Bennett Trim Tabs Calibration**

Trim Tabs will be calibrated through their Device Configuration menu.

#### **To calibrate Trim Tabs:**

1. Press **MENU | MENU**, select **BUS SETUP** and press **ENT**. A list of network devices will appear.
2. Select **BENNETT TRIM TABS** from the list and press **ENT**, which will open the Trim Tab Device Configuration menu.
3. Highlight **CALIBRATE** and press **ENT**. The Device Calibration window will appear with a list of calibration instructions.
4. Select **START CALIBRATION** and press **ENT**. The following message will appear: *Please fully raise Trim Tabs.*
5. After fully raising the trim tabs, press **ENT**. The following message will appear: *Please fully lower trim tabs.*
6. After fully lowering the trim tabs, press **ENT**. A Calibration Complete message will appear. Press **ENT**. Press **EXIT** repeatedly to return to the main display.



**Reset Calibration highlighted (left). Reset Calibration confirmation window (right).**

**To Reset Calibration:**

1. Press **MENU | MENU**, select **NMEA 2000** and press **ENT**.
2. Highlight **FUEL MANAGEMENT** and press **ENT**.
3. Highlight **ENGINE SELECT** and press **ENT**. The Engine Select menu will appear with up to four options: All Engines, Port, Center and Starboard. Selecting All Engines will reset calibration for all engines back to factory defaults.
4. Select All Engines or the engine connected to the desired device and press **ENT**.
5. Highlight **RESET CALIBRATION** and press **ENT**. The following message will appear: *Are you sure you wish to Reset Calibration?*
6. Highlight **YES** and press **ENT**. Press **EXIT** repeatedly to get back to the main display.

# Notes

# Section 11: Supplemental Material

## Datums Used by This Unit

|  |   |  |
|--|---|--|
| WGS 1984<br>Default  | Zaire, Zambia and<br>Zimbabwe                         | Australian Geodetic<br>1984 - Australia &<br>Tasmania          |
| Adindan<br>Mean for Ethiopia,<br>Sudan                         | Arc 1950 - Botswana<br><br>Arc 1950 - Burundi         | Ayabelle Lighthouse -<br>Djibouti                              |
| Adindan<br>Burkina Faso  | Arc 1950 - Lesotho<br><br>Arc 1950 - Malawi           | Bellevue (IGN) - Efa-<br>te & Erromango I-<br>slands           |
| Adindan<br>Cameroon  | Arc 1950 - Swaziland                                  | Bermuda 1957 -<br>Bermuda                                      |
| Adindan<br>Ethiopia  | Arc 1950 - Zaire<br><br>Arc 1950 - Zambia             | Bissau - Guinea-<br>Bissau<br>Bogota Observatory -<br>Colombia |
| Adindan<br>Mali  | Arc 1950 - Zimbabwe                                   |  |
| Adindan<br>Senegal   | Arc 1960 - Mean for<br>Kenya, Tanzania                | Bukit Rimpah - Indo-<br>nesia (Bangka & Beli-<br>tung Islands) |
| Adindan<br>Sudan   | Ascension Island<br>1958 - Ascension<br>Island        | Camp Area Astro -<br>Antarctica (McMurdo<br>Camp Area)         |
| Afgooye<br>Somalia   | Astro Beacon E 1945<br>- Iwo Jima                     | Campo Inchauspe -<br>Argentina                                 |
| Ain el Abd 1970<br>Bahrain                                     | Astro DOS 71/4 - St.<br>Helena Island                 | Canton Astro 1966 -<br>Phoenix Islands                         |
| Ain el Abd 1970<br>Saudi Arabia                                | Astro Tern Island<br>(FRIG) 1961 - Tern<br>Island     | Cape - South Africa  |
| Anna 1 Astro 1965<br>Cocos Islands                             | Astronomical Station<br>1952 - Marcus Island          | Cape Canaveral -<br>Bahamas, Florida                           |
| Antigua Island Astro<br>1943; Antigua (Lee-<br>ward Islands)   | Australian Geodetic<br>1966 - Australia &<br>Tasmania | Carthage - Tunisia<br><br>Switzerland                          |
| Arc 1950; Mean for<br>Botswana, Lesotho,<br>Malawi, Swaziland, |   | Chatham Island Astro<br>1971; New Zealand<br>(Chatham Island)  |

|   |   |  |
|---|---|--|
| Chua Astro<br>Paraguay  | European 1950<br>England, Channel<br>Islands, Ireland,<br>Scotland, Shetland<br>Islands | L.C. 5 Astro 1961<br>Cayman Brac Island                            |
| Corrego Alegre<br>Brazil  |   | Leigon<br>Ghana  |
| Dabola<br>Guinea  | European 1950<br>Finland, Norway  | Liberia 1964<br>Liberia  |
| Djakarta (Batavia)<br>Indonesia (Sumatra)   | European 1950<br>Greece   | Luzon<br>Philippines (Exclud-<br>ing Mindanao)                     |
| DOS 1968<br>New Georgia Islands<br>(Gizo Island)  | European 1950<br>Iran   | Luzon<br>Philippines (Min-<br>danao)                               |
| Easter Island 1967<br>Easter Island   | European 1950<br>(Sicily)   | Mahe 1971<br>Mahe Island   |
| European 1950<br>Mean for Austria,<br>Belgium, Denmark,<br>Finland, France,<br>West Germany, Gi-<br>braltar, Greece, Italy,<br>Luxembourg, Nether-<br>lands, Norway, Por-<br>tugal, Spain, Swe-<br>den, Switzerland | European 1950<br>Malta  | Massawa<br>Ethiopia (Eritrea)                                      |
|   | Ireland 1965<br>Ireland   | Merchich<br>Morocco  |
|   | ISTS 061 Astro 1968<br>South Georgia Is-<br>lands                                       | Midway Astro 1961<br>Midway Islands                                |
|   | ISTS 073 Astro 1969<br>Diego Garcia   | Minna<br>Cameroon  |
| European 1950<br>Mean for Austria,<br>Denmark, France,<br>West Germany,<br>Netherlands, Switzer-<br>land  | Johnston Island 1961<br>Johnston Island   | Minna<br>Nigeria   |
| European 1950<br>Mean for Iraq, Israel,<br>Jordan, Lebanon,<br>Kuwait, Saudi Arabia,<br>Syria   | Kandawala<br>Sri Lanka  | Montserrat Island<br>Astro 1958; Montser-<br>rat (Leeward Islands) |
|   | Kerguelen Island<br>1949<br>Kerguelen Island  | M'Poraloko<br>Gabon, Nahrwan,<br>Oman (Masirah Is-<br>land)        |
| European 1950<br>Cyprus   | Kertau 1948<br>West Malaysia &<br>Singapore   | Nahrwan<br>Saudi Arabia  |
| European 1950<br>Egypt  | Kusaie Astro 1951<br>Caroline Islands   | Nahrwan<br>United Arab Emirates                                    |



|  |   |   |
|--|---|---|
| Naparima BWI<br>Trinidad & Tobago  | North American 1927<br>Canada (Alberta,<br>British Columbia)                                  | Old Hawaiian<br>Mean for Hawaii,<br>Kauai, Maui, Oahu   |
| North American 1927<br>Mean for Antigua,<br>Barbados, Barbuda,<br>Caicos Islands,<br>Cuba, Dominican<br>Republic, Grand<br>Cayman, Jamaica,<br>Turks Islands | North American 1927<br>Canada (Manitoba,<br>Ontario)  | Old Hawaiian<br>Hawaii  |
| North American 1927<br>Mean for Belize, Cos-<br>ta Rica, El Salvador,<br>Guatemala, Hondu-<br>ras, Nicaragua   | North American 1927<br>Canada (New<br>Brunswick, New-<br>foundland, Nova Sco-<br>tia, Quebec) | Old Hawaiian<br>Kauai   |
| North American 1927<br>Mean for Canada   | North American 1927<br>Canada (Northwest<br>Territories, Sas-<br>katchewan)                   | Old Hawaiian<br>Maui  |
| North American 1927<br>Mean for CONUS<br>(Continental United<br>States)  | North American 1927<br>Canada (Yukon)   | Old Hawaiian<br>Oahu  |
| North American 1927<br>Mean for CONUS<br>(East of Mississippi<br>River) including Lou-<br>isiana, Missouri, Min-<br>nesota                                   | North American 1927<br>Cuba   | Oman<br>Oman  |
| North American 1927<br>Mean for CONUS<br>(West of Mississippi<br>River)  | North American 1927<br>Greenland (Hayes<br>Peninsula)   | Ordinance Survey<br>Great Britain 1936 -<br>Mean for England,<br>Isle of Man, Scotland,<br>Shetland Islands,<br>Wales |
| North American 1927<br>Alaska  | North American 1927<br>Mexico   | Ordinance Survey<br>Great Britain 1936 -<br>England   |
| North American 1927<br>Bahamas (Except<br>San Salvador Island)   | North American 1927<br>Alaska, Canada,<br>CONUS   | Ordinance Survey<br>Great Britain 1936 -<br>England, Isle of Man,<br>Wales  |
| North American 1927<br>Bahamas (San Sal-<br>vador Island)  | North American 1983<br>Central America,<br>Mexico   | Ordinance Survey<br>Great Britain 1936 -<br>Scotland, Shetland<br>Islands   |
|  | Observaorio Metereo<br>1939; Azores (Corvo<br>& Flores Islands)                               | Ordinance Survey<br>Great Britain 1936 -<br>Wales   |
|  | Old Egyptian 1907<br>Egypt  | Pico de las Nieves<br>Canary Islands  |
|  |   | Pitcairn Astro 1967<br>Pitcairn Island  |

|  |  |   |
|--|--|---|
| Point 58   |  | Tokyo                                     |
| Sweden   | South American 1969<br>Chile                                   | Mean for Japan, Korea, Okinawa            |
| Santo (DOS)<br>1965 Espirito Santo<br>Island   | South American 1969<br>Colombia                                | Tokyo<br>Japan                            |
| Sao Braz<br>Azores (Sao Miguel,<br>Santa Maria Islands)  | South American 1969<br>Ecuador                                 | Tokyo<br>Korea                            |
| Sapper Hill 1943<br>East Falkland Island   | South American 1969<br>Ecuador (Baltra, Galapagos)             | Tokyo                                     |
| Schwarzeck<br>Nambia   | South American 1969<br>Guyana                                  | Okinawa                                   |
| Selvagem Grande<br>Salvage Islands   | South American 1969<br>Paraguay<br>South American 1969<br>Peru | Tristan Astro 1968<br>Tristan da Cunha    |
| SGS 85<br>Soviet Geodetic System 1985  | South American 1969<br>Trinidad & Tobago                       | Viti Levu 1916<br>Fiji (Viti Levu Island) |
| South American 1969<br>Mean for Argentina,<br>Bolivia, Brazil, Chile,<br>Colombia, Ecuador,<br>Guyana, Paraguay,<br>Peru, Trinidad & Tobago, and Venezuela | South American 1969<br>Venezuela                               | Wake                                      |
| South American 1969<br>Argentina   | South Asia   | Eniwetok 1960                             |
| South American 1969<br>Bolivia   | Singapore  | Marshall Islands                          |
| South American 1969<br>Brazil  | Tananarive Observatory 1925; Madagascar                        | Wake Island Astro 1952<br>Wake Atoll      |
|  | Timbalai 1948<br>Brunei, East Malaysia (Sabah, Sarawak)        | WGS 1972<br>Global Definition             |
|  |  | Yacare<br>Uruguay                         |
|  |  | Zanderij<br>Suriname                      |

# Notes

# Notes

# Notes

## FCC Compliance

This device complies with Part 15 of the U.S. Federal Communications Commission (FCC) Rules. Operation is subject to the following two conditions: (1) this device may not cause harmful interference, and (2) this device must accept any interference received, including interference that may cause undesired operation.

Changes or modifications not expressly approved by the manufacturer could void the user's authority to operate the equipment.

**Note:**

This equipment has been tested and found to comply with the limits for a Class B digital device, pursuant to Part 15 of the FCC Rules. These limits are designed to provide reasonable protection against harmful interference in a residential installation. This equipment generates, uses and can radiate radio frequency energy and, if not installed and used in accordance with the instructions, may cause harmful interference to radio communications. However, there is no guarantee that interference will not occur in a particular installation. If this equipment does cause harmful interference to radio or television reception, which can be determined by turning the equipment off and on, the user is encouraged to try to correct the interference by one or more of the following measures:

- Reorient or relocate the receiving antenna.
- Increase the separation between the equipment and receiver.
- Connect the equipment into an outlet on a circuit different from that to which the receiver is connected.
- Consult the factory customer service department for help.

## LOWRANCE DATABASES LICENSE AGREEMENT

THIS IS A LEGAL AGREEMENT BETWEEN THE END-USER WHO FIRST PURCHASES THIS PRODUCT AS A CONSUMER ITEM FOR PERSONAL, FAMILY, OR HOUSEHOLD USE ("YOU") AND LOWRANCE ELECTRONICS, INC., THE MANUFACTURER OF THIS PRODUCT ("WE", "OUR", OR "US"). USING THE PRODUCT ACCOMPANIED BY THIS LICENSE AGREEMENT CONSTITUTES ACCEPTANCE OF THESE TERMS AND CONDITIONS. IF YOU DO NOT ACCEPT ALL TERMS AND CONDITIONS, PROMPTLY RETURN THE PRODUCT WITHIN 30 DAYS OF PURCHASE. PLEASE RETURN USING THE ENCLOSED UPS SHIPPING LABEL AND INCLUDE: PROOF OF PURCHASE, NAME, ADDRESS, AND PHONE NUMBER. YOUR PURCHASE PRICE AND ANY APPLICABLE TAXES WILL BE REFUNDED. PLEASE ALLOW 4-6 WEEKS TO PROCESS YOUR REFUND.

1. This License Agreement applies to the one or more databases that your product may contain. We refer to these singly as a "Database" and together as the "Databases." Your product may thus include the "WBS Database" which contains worldwide background surface mapping data, the "SmartMap Database" which contains inland mapping data, or other Databases.
2. The Databases that your product may contain are licensed, not sold. We grant to you the nonexclusive, nonassignable right to use these Databases for supplemental navigation reference purposes, but only as long as you comply with the terms and conditions of this License Agreement. We reserve the right to terminate this license if you violate any aspect of this License Agreement. You are responsible for using official government charts and prudent navigation for safe travel.
3. The Databases housed in your product are protected by the copyright notices appearing on the product or its screen(s). You may NOT modify, adapt, translate, reverse engineer, decompile, disassemble, rent, lease, or resell any Database, and you may NOT create derivative works based upon any Database or its contents. Any unauthorized reproduction, use, or transfer of a Database may be a crime and may subject you to damages and attorney fees.
4. This License Agreement will terminate immediately without prior notice from us if you fail to comply with or violate any of the provisions of this Agreement. Upon termination, you will promptly return all products containing one or more Databases to us.
5. Prices and programs are subject to change without notice.
6. This License Agreement shall be governed by the laws of the State of Oklahoma and comprises the complete and exclusive understanding between you and us concerning the above subject matter.

## **DATABASES LIMITED WARRANTY**

"We", "our", or "us" refers to Lowrance Electronics, Inc., the manufacturer of this product. "You" or "your" refers to the first person who purchases the product as a consumer item for personal, family, or household use. The Databases Limited Warranty applies to the one or more databases that your product may contain. We refer to each of these as a "Database" or together as the "Databases." Your product may thus include the "WBS Database" which contains worldwide background surface mapping data, the "SmartMap Database" which contains inland mapping data, or other Databases.

We warrant to you that we have accurately compiled, processed, and reproduced the portions of the source material on which the Databases are based. However, we are under no obligation to provide updates to the Databases, and the data contained in the Databases may be incomplete when compared to the source material. **WE MAKE NO EXPRESS OR IMPLIED WARRANTY OF ANY KIND ABOUT THE ACCURACY OF THE SOURCE MATERIAL ITSELF, INCLUDING BUT NOT LIMITED TO IMPLIED WARRANTIES OF MERCHANTABILITY OR FITNESS FOR A PARTICULAR PURPOSE.**

If there is a defect in any Database, your exclusive remedy shall be, at our option, either a refund of the price you paid for the product containing the defective Database or a replacement of such product. **WE WILL NOT UNDER ANY CIRCUMSTANCES BE LIABLE TO ANYONE FOR ANY SPECIAL, CONSEQUENTIAL, INCIDENTAL, OR OTHER INDIRECT DAMAGE OF ANY KIND.**

Some states do not allow the exclusion or limitation of incidental or consequential damages, so the above limitations or exclusions may not apply to you.

This warranty does NOT apply in the following circumstances: (1) when the product has been serviced or repaired by anyone other than us; (2) when the product has been connected, installed, combined, altered, adjusted, or handled in a manner other than according to the instructions furnished with the product; (3) when any serial number has been effaced, altered, or removed; or (4) when any defect, problem, loss, or damage has resulted from any accident, misuse, negligence, or carelessness, or from any failure to provide reasonable and necessary maintenance in accordance with the instructions of the owner's manual for the product.

We reserve the right to make changes or improvements in our products from time to time without incurring the obligation to install such improvements or changes on equipment or items previously manufactured.

This warranty gives you specific legal rights and you may also have other rights which may vary from state to state.

Your remedies under this warranty will be available so long as you can show in a reasonable manner that the defect occurred within one (1) year from the date of your original purchase, and we must receive your warranty claim no later than 30 days after such 1-year period expires. Your claim must be substantiated by a dated sales receipt or sales slip.



## **LOWRANCE ELECTRONICS FULL ONE-YEAR WARRANTY**

"We," "our," or "us" refers to LOWRANCE ELECTRONICS, INC., the manufacturer of this product. "You" or "your" refers to the first person who purchases this product as a consumer item for personal, family or household use.

We warrant this product against defects or malfunctions in materials and workmanship, and against failure to conform to this product's written specifications, all for one (1) year from the date of original purchase by you. **WE MAKE NO OTHER EXPRESS WARRANTY OR REPRESENTATION OF ANY KIND WHATSOEVER CONCERNING THIS PRODUCT.** Your remedies under this warranty will be available so long as you can show in a reasonable manner that any defect or malfunction in materials or workmanship, or any non-conformity with the product's written specifications, occurred within one year from the date of your original purchase, which must be substantiated by a dated sales receipt or sales slip. Any such defect, malfunction, or non-conformity which occurs within one year from your original purchase date will either be repaired without charge or be replaced with a new product identical or reasonably equivalent to this product, at our option, within a reasonable time after our receipt of the product. If such defect, malfunction, or non-conformity remains after a reasonable number of attempts to repair by us, you may elect to obtain without charge a replacement of the product or a refund for the product. **THIS REPAIR, OR REPLACEMENT OR REFUND (AS JUST DESCRIBED) IS THE EXCLUSIVE REMEDY AVAILABLE TO YOU AGAINST US FOR ANY DEFECT, MALFUNCTION, OR NON-CONFORMITY CONCERNING THE PRODUCT OR FOR ANY LOSS OR DAMAGE RESULTING FROM ANY OTHER CAUSE WHATSOEVER. WE WILL NOT UNDER ANY CIRCUMSTANCES BE LIABLE TO ANYONE FOR ANY SPECIAL, CONSEQUENTIAL, INCIDENTAL, OR OTHER INDIRECT DAMAGE OF ANY KIND.**

Some states do not allow the exclusion or limitation of incidental or consequential damages, so the above limitations or exclusions may not apply to you.

This warranty does NOT apply in the following circumstances: (1) when the product has been serviced or repaired by anyone other than us; (2) when the product has been connected, installed, combined, altered, adjusted, or handled in a manner other than according to the instructions furnished with the product; (3) when any serial number has been effaced, altered, or removed; or (4) when any defect, problem, loss, or damage has resulted from any accident, misuse, negligence, or carelessness, or from any failure to provide reasonable and necessary maintenance in accordance with the instructions of the owner's manual for the product.

We reserve the right to make changes or improvements in our products from time to time without incurring the obligation to install such improvements or changes on equipment or items previously manufactured.

This warranty gives you specific legal rights and you may also have other rights which may vary from state to state.

**REMINDER:** You must retain the sales slip or sales receipt proving the date of your original purchase in case warranty service is ever required.

**LOWRANCE ELECTRONICS  
12000 E. SKELLY DRIVE, TULSA, OK 74128  
(800) 324-1356**

## **How to Obtain Service...**

### **...in the USA:**

We back your investment in quality products with quick, expert service and genuine Lowrance parts. If you're in the United States and you have technical, return or repair questions, please contact the Factory Customer Service Department. Before any product can be returned, you must call customer service to determine if a return is necessary. Many times, customer service can resolve your problem over the phone without sending your product to the factory. To call us, use the following toll-free number:

**800-324-1356**

8 a.m. to 5 p.m. Central Standard Time, M-F

*Lowrance Electronics may find it necessary to change or end our shipping policies, regulations, and special offers at any time. We reserve the right to do so without notice.*

### **...in Canada:**

If you're in Canada and you have technical, return or repair questions, please contact the Factory Customer Service Department. Before any product can be returned, you must call customer service to determine if a return is necessary. Many times, customer service can resolve your problem over the phone without sending your product to the factory. To call us, use the following toll-free number:

**800-661-3983**

**905-629-1614 (not toll-free)**

8 a.m. to 5 p.m. Eastern Standard Time, M-F

### **...outside Canada and the USA:**

If you have technical, return or repair questions, contact the dealer in the country where you purchased your unit. To locate a dealer near you, visit our web site, [www.lowrance.com](http://www.lowrance.com) and look for the Dealer Locator.

## **Accessory Ordering Information for all countries**

To order Lowrance GPS accessories such as power cables or MMC cards, please contact:

1) Your local marine dealer, sporting goods or consumer electronics store. Most quality dealers that handle marine electronic equipment or other consumer electronics should be able to assist you with these items.

To locate a Lowrance dealer near you, visit our web site, [www.lowrance.com](http://www.lowrance.com) and click on Support and then click Dealer Locator. Or, you can consult your telephone directory for listings.

2) U.S. customers: LEI Extras Inc., PO Box 129, Catoosa, OK 74015-0129  
Call 1-800-324-0045 or visit our web site [www.lei-extras.com](http://www.lei-extras.com).

3) Canadian customers can write:

Lowrance/Eagle Canada, 919 Matheson Blvd. E. Mississauga, Ontario L4W2R7 or fax 905-629-3118.

## **Shipping Information**

If it becomes necessary to send a product for repair or replacement, you must first receive a return authorization number from Customer Service. Products shipped without a return authorization will not be accepted. When shipping, we recommend you do the following:

1. Please do not ship knobs or mounting brackets with gimbal units.
2. If your unit saves sonar logs or GPS data files to memory cards, make sure you have saved the data to a memory card and that the card has been removed from the unit, otherwise your data will be lost.
3. If you are sending a check for repair, please place your check in an envelope and tape it to the unit.
4. For proper testing, include a brief note with the product describing the problem. Be sure to include your name, return shipping address and a daytime telephone number. An e-mail address is optional but useful.
5. Pack the unit in a suitable size box with packing material to prevent any damage during shipping.
6. Write the Return Authorization (RA) number on the outside of the box underneath your return address.
7. For your security, you may want to insure the package through your shipping courier. Lowrance does not assume responsibility for goods lost or damaged in transit.



Visit our web site:



Lowrance Pub. 988-0152-181

Printed in USA 120406

© Copyright 2006  
All Rights Reserved  
Lowrance Electronics, Inc.